

# Data Sheet

## High Power Programmable DC Power Supplies PVS Series



The PVS10005, PVS60085, and PVS60085MR programmable DC power supplies offer clean output power up to 5.1 kW, excellent regulation, and fast transient response time characteristics in an industry leading 2U package.

These power supplies provide many useful features such as high programming resolution, multiple remote interfaces for test systems, and a built-in SAS (solar array simulator) function to generate PV (photovoltaic) I-V curves. The optional SAS software allows users to consistently reproduce various I-V curves to test a PV inverter's MPPT efficiency.

For benchtop applications, this series provides an intuitive user interface with full keypad and rotary knob. System integrators benefit from the standard USB (virtual COM), RS232, GPIB, and LAN interfaces supporting SCPI commands. Free application software and a complete set of LabVIEW drivers are available to reduce

programming time and increase productivity. The application software allows users to control the power supply, execute test sequences, or log measurements. It also integrates with Data Dashboard for LabVIEW apps, enabling users to remotely monitor select measurement indicators with iOS, Android, or Windows 8 compatible tablets or smart phones.

These power supplies are well suited for both bench use and ATE systems integration, R&D, design verification, production test, and high voltage testing.

### Special Applications

In particular, the low-noise characteristic of the PVS Series makes these instruments ideal for motor inverter testing. When operated with the optional SAS software, these power supplies can be used for solar array testing applications.

### Features & Benefits

- Compact, high power density, 2U package
- Output up to 1000 V / 5 A (PVS10005) and 600 V / 8.5 A (PVS60085 & PVS60085MR)
- Convenient single-phase AC input configuration
- Bright VFD display
- High voltage and current resolution of 0.1 V, 0.1 mA (PVS10005) or 10 mV, 0.2 mA (PVS60085 & PVS60085MR)
- Fast transient response time of  $\leq 0.5$  ms
- Adjustable voltage and current slope (rise and fall times)
- List mode: 9 user-defined programs with up to 100 programmable steps each
- Built-in SAS function for storage of up to 16 I-V curves with Voc, Isc, Vmp, and Imp parameters and 1024-point table
- Store up to 100 different instrument settings to internal memory
- Control up to 30 power supplies from one PC via the RS485 interface
- Timer-controlled output (1 s to 1000 hrs)
- Standard USB (virtual COM), RS232, RS485, GPIB and LAN interfaces
- External analog programming and monitoring interface
- Extensive protection features: OVP, OCP, OPP, OTP, foldback protection mode, and key-lock function
- Front to rear airflow allows for efficient cooling in high rack density environments
- Master/slave mode for up to four units in parallel (20.4 kW total)
- LabVIEW™ driver and softpanel for remote control, test sequence generation, and datalogging available

Model	PVS10005	PVS60085	PVS60085MR**
Max Output Voltage	1000 V	600 V	600 V
Max Output Current	5 A	8.5 A	8.5 A
Max Output Power	5000 W	5100 W	3000 W

\*\*Model PVS60085MR is a multi-ranging supply allowing any combination of the rated voltage and current up to the maximum output power of 3000 W.

**Distributed By:**  
**Signal Test, Inc**  
1529 Santiago Ridge Way  
San Diego, CA 92154  
Tel. 1-619-575-1577 USA  
www.SignalTestInc.com  
Sales@SignalTestInc.com

Included Accesso



## Front panel



### Intuitive user interface

The numeric keys and rotary knob provide a convenient interface for setting output levels quickly and precisely. Both measured output values and setting values are concurrently displayed on the screen. Additionally, the power supplies provide internal memory for storage of up to 10 different instrument settings that can be set and recalled via both the front panel and remote interfaces.

## Rear panel

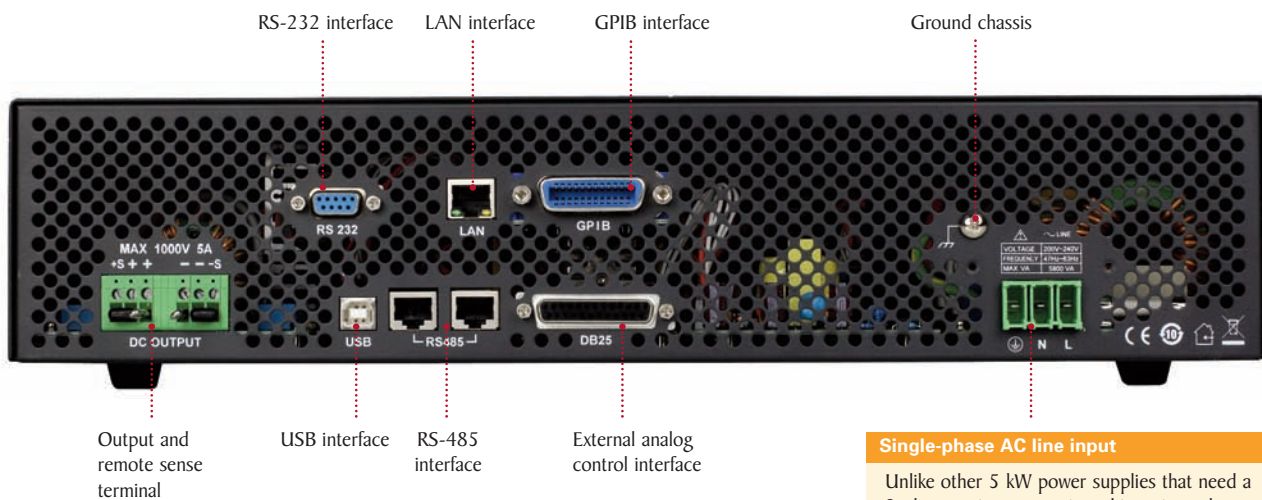

**Single-phase AC line input**  
Unlike other 5 kW power supplies that need a 3-phase mains connection, this series only requires a single-phase connection, which is easier to wire and much more commonly available than 3-phase AC outlets.

Included Accesso

**Distributed By:**  
Signal Test, Inc  
1529 Santiago Ridge Way  
San Diego, CA 92154  
Tel. 1-619-575-1577 USA  
www.SignalTestInc.com  
Sales@SignalTestInc.com



## Remote control and programming

### Test system integration

These power supplies offer standard USB, RS-232, GPIB, and LAN interfaces to facilitate test system development and integration. The PVS Series supports SCPI-compliant protocols and come with LabVIEW™ drivers.

### Test sequence execution in list mode

The list mode feature allows users to program a list of steps to the power supply's internal memory and execute them. A total of 100 steps can be allocated to each internal memory location, up to a maximum of 9 locations. The test sequence can be programmed remotely via the USB, RS-232, GPIB, or LAN interfaces using SCPI commands or with the included application software. Test sequences can be configured for single or repeated execution. Each steps' settings include voltage, current, duration, and output status.

### Analog programming and monitoring interface

In addition to front panel and remote interface control, voltage and current values can also be programmed with an analog control signal. The power supplies can be externally controlled from zero to full scale by either voltage source (0-5 V/0-10 V selectable) or resistance (0-5 kΩ/0-10 kΩ selectable for high voltage models). The analog interface also offers the ability to monitor the output voltage and current, regulation mode (CV or CC), or to indicate the occurrence of a fault condition.

### Application software

PC software is provided for front panel emulation, generating and executing test sequences or logging measurement data without the need to write source code.

- Remote monitoring on iOS, Android, or Windows 8 compatible tablets or smart phones via NI Data Dashboard for LabVIEW apps. Quickly develop a custom dashboard consisting of one (smart phone) or several (tablet) indicators, charts, or gauges to monitor your power supply.
- Log voltage, current, and power values as well as time stamp, CV/CC, and output status.
- Save and load list files to/from the power supply's internal memory.
- Create an unlimited number of external list files to be executed from PC memory. Save and recall list files to/from the PC.

### Web server interface

The PVS Series models provide a built-in web server that allows users to configure, control, or monitor the basic settings of the power supply from a remote computer using a web browser.

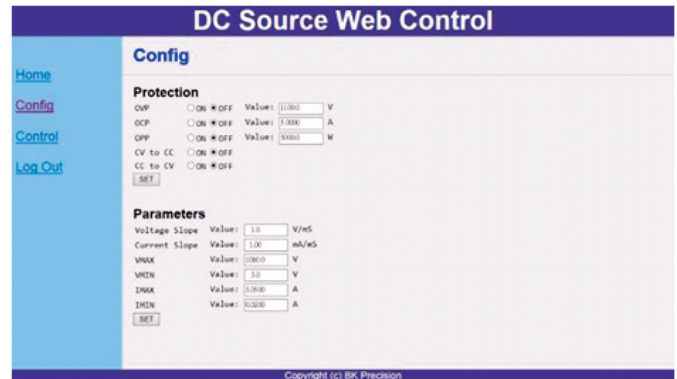

### Socket and Telnet interface

The power supply can be controlled with SCPI commands using a socket or Telnet connection via the Ethernet interface.



## Flexible configuration

### Extensive device protection

To protect your DUT, the PVS Series provides several safety features: over-voltage (OVP), overcurrent (OCP), overpower (OPP), and overtemperature (OTP) protection. When a fault occurs, the power supply will turn off the output, sound an alarm, and display an error message. Similarly, with constant voltage-to-constant current (CV-to-CC) or constant current-to-constant voltage (CC-to-CV) foldback protection mode activated, the supply will shut down if load changes force the supply to transition between the two operating modes. The power supply is also able to detect abnormally low or high AC input power and turn the output off when this condition occurs.

### Convenient front panel guided calibration

Using a 5 ½ digit multimeter, voltage and current parameters can be conveniently calibrated from the front panel via the calibration menu.

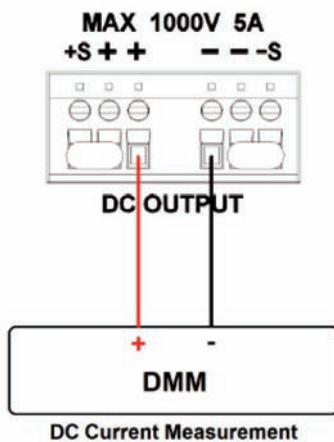

AC input power cord (Standard)	Rackmount kit (Optional)
	

Distributed By:  
Signal Test, Inc  
1529 Santiago Ridge Way  
San Diego, CA 92154  
Tel. 1-619-575-1577 USA  
www.SignalTestInc.com  
Sales@SignalTestInc.com

### Multi-unit control

In multi-unit control mode, up to 30 units can be daisy chained via RS485 and controlled from one master unit through the USB, GPIB, or LAN interface.

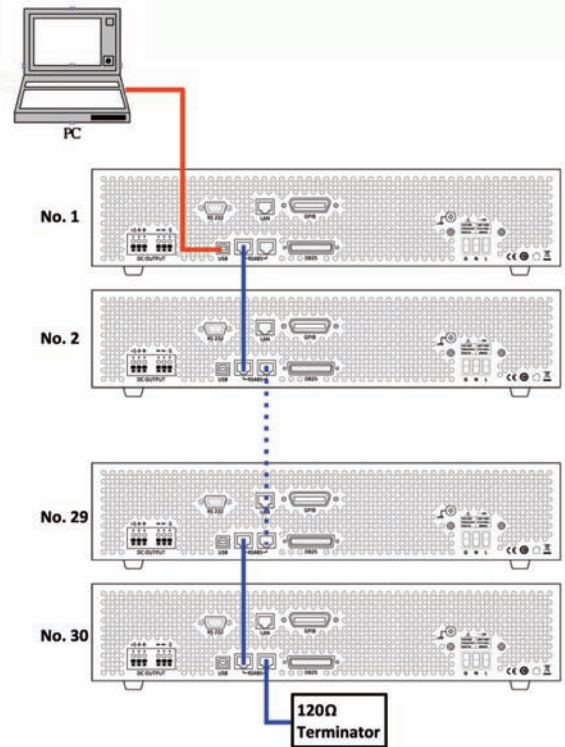

### Master/Slave operation

Up to four models with the same rating can be connected in parallel and operate in master/slave mode. The RS-485 interface is used for communication between the master and slave(s). Once configured, the master will automatically search for and detect slave units, and display the voltage and current of the complete system.

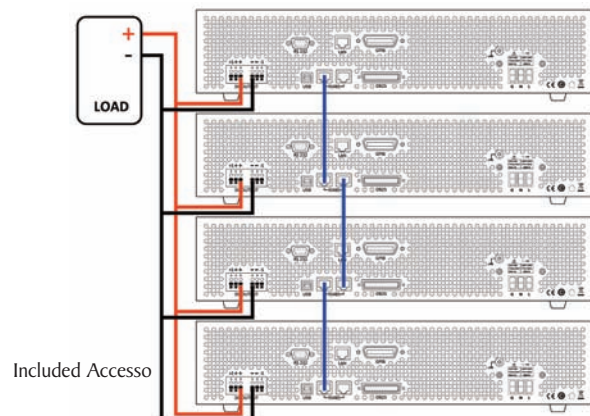

## Solar Array Simulation (SAS) Software Option

Solar inverter designers need to verify their inverter is capable of delivering the maximum power available from solar modules. The I-V curve of solar cells can be influenced by various weather conditions such as a cloudy day. Combined with the SAS application software, PVS users can easily simulate the I-V curve of different arrays under various irradiance conditions while measuring and validating the effectiveness of the inverter's MPPT algorithm.

### Features

- Variety of input parameters (Voc/Isc/Vmp/Imp/FF/FFv/FFi)
- Monitors and logs real-time voltage, current, power, MPPT efficiency, and average MPPT efficiency
- Simulate I-V curve under different weather conditions during a day
- User-definable irradiance profile
- Generate a custom I-V curve with up to 1,024 data points



### PV Simulation

Solar arrays consist of multiple solar cells characterized by a complex voltage and current profile that is represented in an I-V curve.

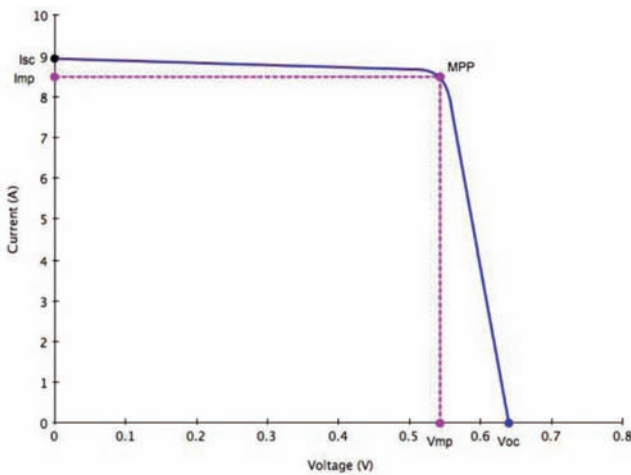

PV simulation curve



Automatically generate the I-V curve of a solar array in the software by specifying open circuit voltage (Voc), short circuit current (Isc), maximum power voltage (Vmp), and maximum power current (Imp) along with fill factor parameters.

A1		
	A	B
1	1000	0
2	999.873	0.0049
3	999.746	0.0098
4	999.619	0.0147
5	999.492	0.0196
6	999.365	0.0244
7	999.238	0.0293
8	999.11	0.0342
9	998.983	0.0391
10	998.856	0.044
11	998.729	0.0489
12	998.602	0.0538
13	998.475	0.0587

Generate an I-V curve manually via a 1,024-point voltage and current table with Notepad or MS Excel and load it in the software.

The PVS power supply outputs points on the I-V curve in 1 ms intervals to test the inverter's MPPT efficiency.

Use any of the software's built-in irradiance profiles or generate your own point-by-point irradiance profile.

Included Accesso

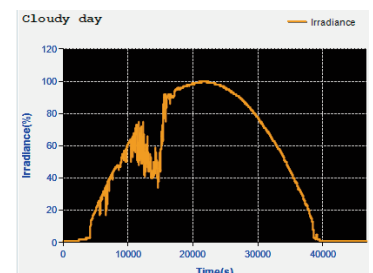

**Distributed By:**  
**Signal Test, Inc**  
1529 Santiago Ridge Way  
San Diego, CA 92154  
Tel. 1-619-575-1577 USA  
www.SignalTestInc.com  
Sales@SignalTestInc.com



## Specifications

Model	PVS60085	PVS60085MR	PVS10005
<b>Output Rating</b>			
Output Voltage <sup>(1)</sup>	0 - 600 V		0 - 1000 V
Output Current <sup>(2)</sup>	0 - 8.5 A		0 - 5 A
Max. Output Power	5100 W	3000 W	5000 W
<b>Line Regulation</b>			
Voltage	60 mV		100 mV
Current	4.25 mA		2.5 mA
<b>Load Regulation</b>			
Voltage	60 mV		100 mV
Current	8.5 mA		5 mA
<b>Ripple and Noise (20 Hz - 20 MHz)</b>			
Voltage	≤ 100 mVrms / ≤ 500 mVpp		≤ 100 mVrms / ≤ 600 mVpp
Current	15 mA		10 mA
<b>Resolution</b>			
Programming	10 mV/0.2 mA		0.1 V/0.1 mA
Readback	10 mV/0.2 mA		0.1 V/0.1 mA
<b>Programming Accuracy</b>			
Voltage	400 mV		700 mV
Current <sup>(3)</sup> ± (%output + offset)	0.03% + 3.5 mA		0.03% + 2 mA
<b>Readback Accuracy ± (%output + offset)</b>			
Voltage	0.05% + 300 mV		0.05% + 500 mV
Current <sup>(3)</sup>	0.1% + 8.5 mA		0.1% + 5 mA
<b>General</b>			
Transient Response Time <sup>(4)</sup>	≤ 0.5 ms		≤ 0.5 ms
OVP adjustment Range	5 - 660 V		5 - 1100 V
OVP Accuracy	6 V		10 V
OCP Accuracy	85 mA		50 mA
Command Response Time	20 ms		20 ms
Efficiency <sup>(5)</sup>	90%		90%
Power Factor	0.99		0.99
Remote Sense Compensation	6 V		10 V
Rising Time at Full Load	≤ 100 ms		≤ 250 ms
Rising Time at No Load	≤ 100 ms		≤ 250 ms
Falling Time at Full Load	≤ 100 ms	≤ 150 ms	≤ 250 ms
Falling Time at No Load	≤ 3000 ms		≤ 5000 ms
Standard Interfaces	Analog Programming, USB, RS485, RS232, GPIB, and Ethernet		
AC Input <sup>(6)</sup>	170 - 265 VAC single phase		
Rated Frequency	47 - 63 Hz		
Maximum Rated Input Power	5800 VA	3500 VA	5800 VA
Temperature Ratings	Operation (0 °C~40 °C) Storage (-40 °C~85 °C)		
Dimensions ( W× H× D )	16.53" x 3.46" x 20.94" (420 x 88 x 532 mm)		
Weight	32.18 lbs (14.6 kg)		
<b>Three-Year Warranty</b>			
Standard Accessories	User manual, power cord, test report & certificate of calibration		
Optional Accessories	SASPVS (SAS software), RKPVS (rackmount kit)		

<sup>(1)</sup> Minimum voltage is guaranteed to 5V.

<sup>(2)</sup> Minimum current is guaranteed to maximum 0.4% of rated output current.

<sup>(3)</sup> Current accuracy is applied when output power > 0.1% of full power.

<sup>(4)</sup> Time for output voltage to recover within 0.5% of its rated output for a load change 50 – 100% of rated output current.

<sup>(5)</sup> 90% typical at nominal line and max load.

<sup>(6)</sup> 10% of output de-rated when operating below 190 VAC.