

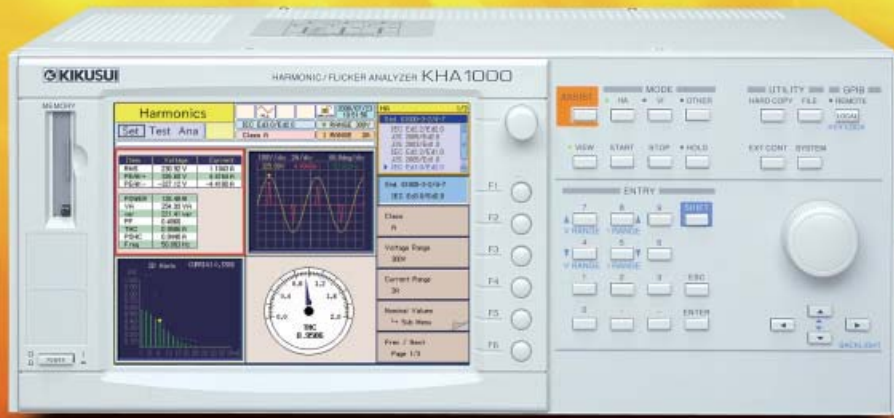

No need for a PC for compliance testing
Real-time measurement that gives you a quick grasp of the EUT status
Assist function that guides you on standards and technical terms
CF card offering smooth interaction with a PC
Test reports available in both PDF and text formats
Equipped with GPIB, RS-232C, and USB interfaces



Harmonic/Flicker Analyzer **MODEL KHA 1000**

Compliant with IEC61000-3-2 Ed3.0 (2005-11), JIS C61000-3-2: Revision (2005-3),
 and IEC61000-3-3 Ed1.2 (2005-10)

Signal Test, Inc
 1529 Santiago Ridge Way
 San Diego, CA 92154
 Tel. 1-619-575-1577 USA
 www.SignalTestInc.com
 Sales@SignalTestInc.com



Harmonic /Flicker Analyzer

Capability to perform basic power supply characteristic measurements at design and development stages

Harmonic and flicker analyzer compliant with the latest versions of the IEC and JIS standards

KHA1000 is a harmonic and flicker analyzer compliant with the relevant IEC/EN and JIS standards that is intended for testing single-phase, two-line equipment. Using this device alone, you can perform a series of processes involved in a compliance test - from setting test conditions and running the test to monitoring the test status in real time, judging test results against limit values, and outputting result reports - through simple operations without the use of a PC. Also, a test system can be set up with ease by combining KHA1000 with an AC power supply (PCR-LA Series) and a line impedance network (LIN40MA-PCR-L).

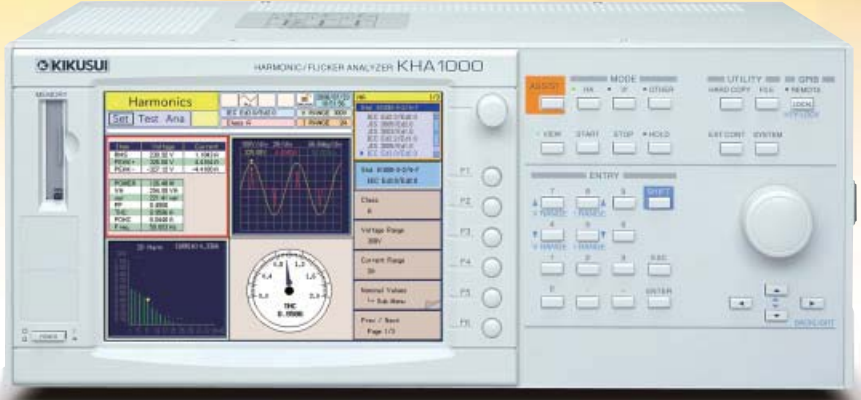

Harmonic/Flicker Analyzer KHA1000

Ver.1.5

[Supported standard] Testing can be done to verify compliance with the standards mentioned below.

Category	Standard name ¹ (used by this product)	Limit value standard name and version	Measurement technology standard name and version ²
Harmonic current	IEC Ed3.0/Ed2.0	IEC 61000-3-2:Ed3.0 (2005) EN61000-3-2:2006	IEC61000-4-7:Ed2.0 (2002) EN 61000-4-7 (2002)
	IEC Ed2.2/Ed2.0	IEC 61000-3-2:Ed2.2 (2004) EN61000-3-2 (2000)/A2 (2005)	IEC61000-4-7:Ed2.0 (2002) EN 61000-4-7 (2002)
	JIS 2005/Ed2.0	JIS C61000-3-2 (2005)	IEC61000-4-7:Ed2.0 (2002)
	JIS 2003/Ed1.0	JIS C61000-3-2 (2003)	JIS C61000-4-7 (1997)
	IEC Ed3.0/Ed1.0	IEC 61000-3-2:Ed3.0 (2005) EN 61000-3-2:2006	IEC61000-4-7 (1991) EN 61000-4-7 (1993)
	IEC Ed2.2/Ed1.0	IEC 61000-3-2:Ed2.2 (2004) EN 61000-3-2 (2000)/A2 (2005)	IEC61000-4-7 (1991) EN 61000-4-7 (1993)
Flicker voltage fluctuation	JIS 2005/Ed1.0	JIS C61000-3-2 (2005)	JIS C61000-4-7 (1997)
	IEC Ed1.2/Ed1.1	IEC61000-3-3:Ed1.2 (2005-10) EN61000-3-3 (1995)/A2 (2005)	IEC61000-4-15:Ed1.1 (2003) EN 61000-4-15 (1998)/A1 (2003)

*1 The standard names shown in the table are the codes used by this product.

*2 Measurement technology standards referenced by the limit value standards (Both old and new versions are supported.)

* The IEC61000-4-7:Ed2.0 standard concerning measuring instruments uses a measurement window width of 10 cycles at 50 Hz or 12 cycles at 60 Hz and introduces interharmonic measurement and grouping.

The IEC61000-4-15:Ed1.1 standard concerning measuring instruments supports a flicker meter covering 0.5 to 33.33 Hz at 230 V/50 Hz.

Single-phase, two-line equipment measurement circuit compliant with harmonic standards (system configuration diagram/example)

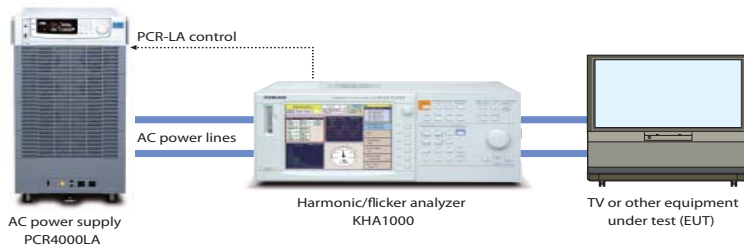

System expansion

A line impedance network (LIN40MA-PCR-L) is required to perform compliance testing for voltage fluctuation and flicker standards. (The device is to be connected between the AC power supply and KHA1000.)



Line impedance network
LIN40MA-PCR-L (built to order)

No need for a PC for compliance testing

Using this device alone, you can perform a series of test processes - from setting test conditions and running the test to judging test results against limit values and outputting result reports - without the use of a PC. The device displays pass/fail results and spectrum data on the screen in real time. What's more, since KIKUSUI's PCR-LA Series AC power supply can be controlled from KHA1000, you can set up an easy-to-use test system whereby the operation panel of this device can be used as the main console.

● Operation flow using KHA1000 - from test condition setting to report printing

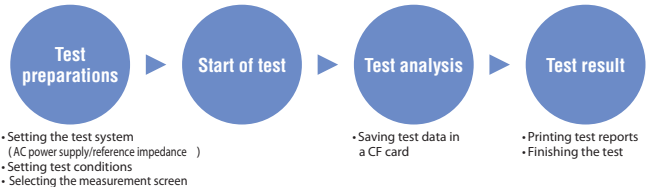

Easy test condition setting

Setting test conditions as appropriate for the equipment under test (EUT) is easy. You can save set test conditions in a file, thereby making it easy to repeat tests under the same conditions as well as to reuse the saved test conditions for other tests with part of the parameters changed. This enables speedy test condition setting in such cases as when you want to run tests on many EUTs under similar conditions. It also helps reduce condition setting mistakes.

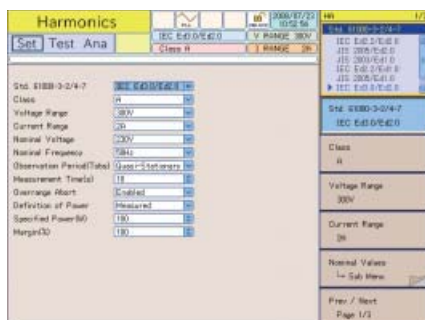

▲ Example of IEC61000-3-2 (Ed3.0) Class A

- An arbitrary nominal voltage value can be input. The specifiable value range is 100 to 300 V.

Guidance on standards and technical terms (Assist function)

The Assist function is provided that guides you on the technical terms used in the standards concerned, as well as through the equipment class setting procedure. Using this function, even those who are not well versed with the standards can readily get started with the test.

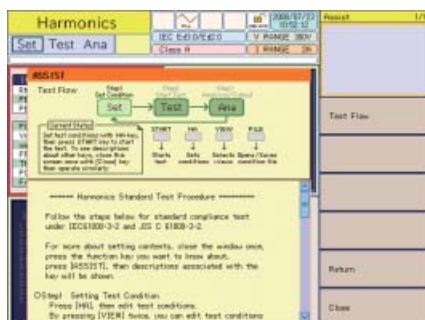

Easy-to-view screen and real-time measurement

KHA1000 features an 8-inch TFT color liquid crystal display. Its graphical display of various data helps you grasp the EUT status at a glance. It also offers a real-time measurement capability that allows you to set and change test conditions while making a measurement. Many conventional test systems deal with the measurement process and the pass/fail judgment process as separate routines, and it often takes time before you get test results. By contrast, KHA1000 enables you to examine the effect of your trial-and-error effort on the circuit in real time while changing judgment criteria. This is very convenient in identifying and solving problems at the development stage.

[List]

Measurement of the basic EUT characteristics (Display of the basic measurement parameters)

[V/I waveform]

Confirmation of input EUT conditions, voltage/current waveform checking, real-time measurement, and current range determination

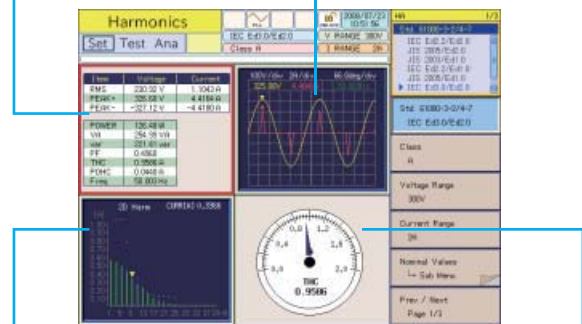

▲ Example of the display screen

[2D harmonics]

Measurement of harmonic current of each order, comparison with limit values, and search for maximum values

[THC]

EUT operating condition setting (THC is an rms value of the 2nd to 40th harmonic components.)

● Display function list

Display Type	Function
Graph display	V/I waveform
	rms waveform
	St (short-time flicker value) waveform
	CPF (cumulative probability) curve (displayed after the start of the test)
	dc waveform (displayed after the start of the test)
	d max waveform (displayed after the start of the test)
List display	d(t) > 3.3% waveform (displayed after the start of the test)
	Flicker list
	(Pst, P0.1, P1s, P3s, P10s, and P50s displayed for each segment)
	Result list (displayed after the end of the test)
	d measurement (manual switchover)

CF card offering smooth interaction with a PC (external memory)

The compact flash (CF) memory card is used to store test conditions and reports, screen hard copies, and other data. This makes it easy to exchange data with a PC. In addition, when the pertinent standard has been revised, you can update the system by plugging in the CF card into KHA1000's front panel.

* The CF card is to be purchased separately by the user.

Support for both PDF and text formats (test reports)

KHA1000 outputs test reports in PDF format to a CF card. You can view and print the reports easily using a PC. Since it is also possible to output report data in text format, you can create test reports in your proprietary format.

Item	Value	Item	Value			
Company		Test Engineer				
Model name		Type of test	EN61000-3-2:2006			
Type		Reference	IEC61000-3-2:2006			
Serial No.		Classification	Class A			
Operating mode		Power analyzer	KHA1000, Ver1.50			
Date of test	2008/07/23 10:47:08	Supply Source				
Climatic condition		Reference Impedance	Bypass			
Memo						
Test Data of Current Harmonics						
Final TEST RESULT: PASS						
Voltage	7.573V	THD	0.849%			
Current	1.1069A	POWCLIMIT	0.044(AV) 0.2813(A ²)			
Power	120.87W	Nominal	2.071 50Hz			
Apparent Power	235.4VA	Fundamental current	0.8490A			
		Measuring period	10s			
		Margin	100%			
Harmonics	Limit(A rms)	Limit(A rms)	Actual(A rms)	Max(A rms)	Limit(Over)	Judge
1	3.600	1.6200	0.0053	0.0004	0.0	NA
2	2.3000	2.4820	0.0224	0.0236	0.0	Pass

▲Test report example (harmonic compliance test)

Quality check function for the test power supply

KHA1000 has the function to measure the voltage, frequency, peak voltage, and distortion rate of the AC power supply used for harmonic compliance testing so as to check whether the power supply is adequate for the intended test.

No.	Wave	Mod	Lim	Mod	No.	Wave	Mod	Lim	Mod
1	100.00				2	0.01	0.02	0.20	
3	0.00	0.00	0.40	0	4	0.00	0.00	0.20	
5	0.00	0.00	0.40	0	6	0.00	0.00	0.20	
7	0.00	0.00	0.20	10	8	0.00	0.00	0.20	
9	0.00	0.00	0.10	10	10	0.00	0.00	0.10	
11	0.00	0.00	0.10	12	0.00	0.00	0.10		
13	0.00	0.00	0.10	14	0.00	0.00	0.10		
15	0.00	0.00	0.10	16	0.00	0.00	0.10		
17	0.00	0.00	0.10	18	0.00	0.00	0.10		
19	0.00	0.00	0.10	20	0.00	0.00	0.10		
21	0.00	0.00	0.10	22	0.00	0.00	0.10		
23	0.00	0.00	0.10	24	0.00	0.00	0.10		
25	0.00	0.00	0.10	26	0.00	0.00	0.10		
27	0.00	0.00	0.10	28	0.00	0.00	0.10		
29	0.00	0.00	0.10	30	0.00	0.00	0.10		
31	0.00	0.00	0.10	32	0.00	0.00	0.10		
33	0.00	0.00	0.10	34	0.00	0.00	0.10		
35	0.00	0.00	0.10	36	0.00	0.00	0.10		
37	0.00	0.00	0.10	38	0.00	0.00	0.10		
39	0.00	0.00	0.10	40	0.00	0.00	0.10		

▲AC power supply check screen [for IEC61000-3-2 (Ed3.0)]

Support for test repeatability checking

It is possible to compare the measurement data you have just obtained against your previous measurement data so as to check whether the margin of error is within the allowable range. This function is helpful in evaluating "repeatability," which is required for harmonic compliance testing.

No.	Wave	Mod	Lim	Mod	No.	Wave	Mod	Lim	Mod
1	0.5202	0.4983	0.3	2	0.0004	0.0003			
3	0.5528	0.5494	0.1	4	0.0008	0.0006			
5	0.4737	0.4742	0.1	6	0.0007	0.0007			
7	0.4094	0.4094	0.1	8	0.0006	0.0006			
9	0.3326	0.3326	0.1	10	0.0006	0.0006			
11	0.2624	0.2624	0.1	12	0.0006	0.0007			
13	0.1961	0.1961	0.1	14	0.0007	0.0006			
15	0.1309	0.1309	0.1	16	0.0006	0.0006			
17	0.0636	0.0636	0.1	18	0.0004	0.0004			
19	0.0004	0.0004	0.1	20	0.0003	0.0003			
21	0.0664	0.0664	0.1	22	0.0002	0.0002			
23	0.0010	0.0010	0.1	24	0.0001	0.0001			
25	0.0175	0.0175	0.1	26	0.0001	0.0001			
27	0.0009	0.0009	0.1	28	0.0001	0.0001			
29	0.0079	0.0079	0.1	30	0.0001	0.0001			
31	0.0013	0.0013	0.1	32	0.0001	0.0001			
33	0.0006	0.0006	0.1	34	0.0001	0.0001			
35	0.0002	0.0002	0.1	36	0.0001	0.0001			
37	0.0001	0.0001	0.1	38	0.0001	0.0001			
39	0.0001	0.0001	0.1	40	0.0001	0.0001			

▲Repeatability check screen

All major basic measurements covered

KHA1000 lets you measure all major basic items including voltage, current, power, power factor, apparent power, reactive power, and frequency. It also provides other measurement functions such as waveform monitoring and rush current measurement. These features make KHA1000 a convenient routine work tool for the development and design processes.

Rush current measurement

KHA1000 enables you to monitor the waveform of a rush current exceeding the trigger level. The waveform of voltage can also be monitored. The current range is fixed to 20 A, allowing measurements of up to 80 A peak.

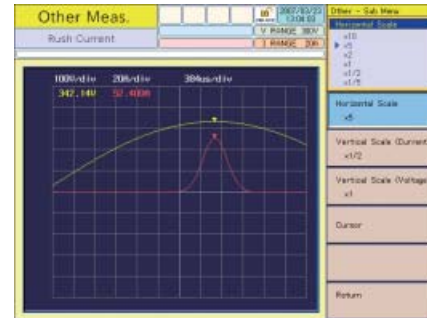

▲Rush current measurement screen

Bilingual display in Japanese and English

You can choose the language to use.

Easy connection

The terminals for power source and load are neatly separated. This arrangement of terminals relieves you of the worry about a connection mistake leading to a short circuit. Of course, voltage sensing is supported for the load terminals as well. KHA1000 offers both simplicity and expandability.

Communication interfaces

KHA1000 comes equipped with GPIB, RS-232C, and USB ports.

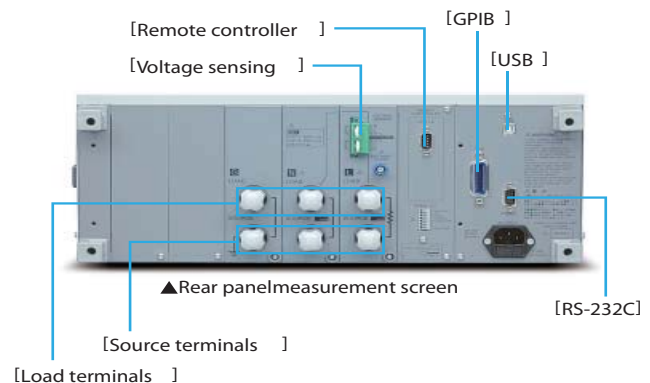

Harmonics Explorer **Ver.3.3**

Software full of convenient features
 that make KHA1000 even easier to use!



SD005-KHA Harmonics Explorer lets you control KHA1000 remotely from a PC and retrieve files storing the results of harmonic current tests and voltage fluctuation tests from KHA1000. It is also possible to analyze test result files saved with HarmoCapture.

■ Program configuration of SD005-KHA Harmonics Explorer

HarmoCapture	<p>Offers the functions to set conditions for harmonic current tests and voltage fluctuation tests, read test conditions, conduct tests, and save and display test result data.</p> <ul style="list-style-type: none"> • Test condition setting • Start and stop of the test • Retrieval of test result files • Display of measurement values • Control of AC power supply PCR-LA • Comment input • Report printing
HA File Analyzer	<p>Offers the functions to analyze harmonic test data.</p> <ul style="list-style-type: none"> • Display of a test result list • Display of graphs (V/I waveform, 2D harmonics, 3D harmonics, current trend, harmonic trend, and THC trend) • Saving of test result files in text format and repeatability check • Report printing
Vf File Analyzer	<p>Offers the functions to analyze voltage fluctuation test data.</p> <ul style="list-style-type: none"> • Display of a test result list • Display of graphs (dc%, dmax%, and d(t) > 3.3%) • Saving of test result files in text format • Report printing

[Connection of the test system]

The configuration diagram of the system for harmonic current and voltage fluctuation testing is shown below. Harmonics Explorer communicates with KHA1000 via the USB (recommended) or GPIB interface. It also communicates with the PCR-LA power supply via the RS-232C (recommended) or GPIB interface. It is therefore necessary to connect each of these devices to a PC.

[Environmental requirements]

- The OS must be Microsoft Windows Vista (Home Premium, Business, or Ultimate), Windows XP Service Pack 2 or later or Windows 2000 Service Pack 4 or later. The PC must have Internet Explorer 5.0 or later installed.
- Microsoft.NET Framework 2.0
- Memory space of 256 MB or more
- XGA or higher resolution
- Free hard disk space of 100 MB or more
- CD-ROM drive
- Mouse or other pointing device
- VISA library (NI-VISA 3.3.0 or later, Agilent I/O Libraries Suite 14.1 or later, or KI-VISA 3.0.4 or later)
- USB cable (only when the USB interface is used)

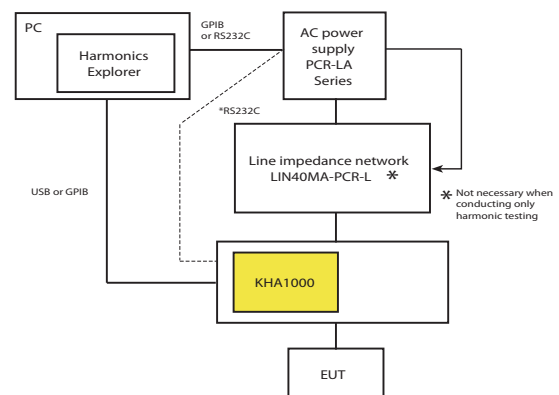

▲System configuration diagram for harmonic current and voltage fluctuation testing

If you have KHA1000 connected to the PCR-LA power supply using RS-232C, reconnect the PCR-LA power supply to the PC.

HarmoCapture

HarmoCapture lets you control KHA1000 remotely from a PC in the same way you control it from the operation panel of the device. The program will start as appropriate for the test mode.

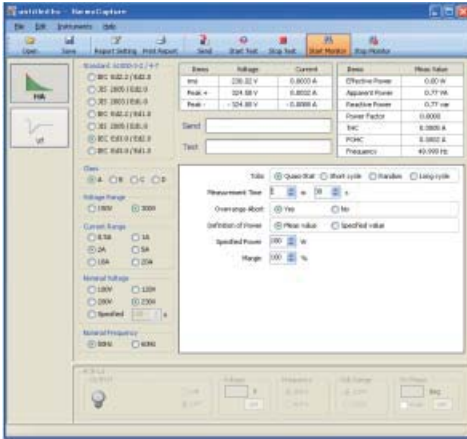

▲ Test condition setting screen for harmonic current testing

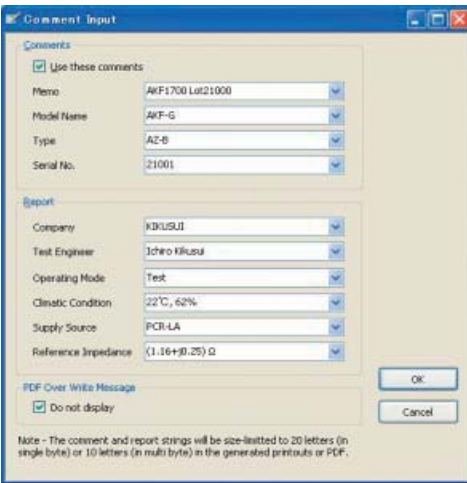

▲ Comment input

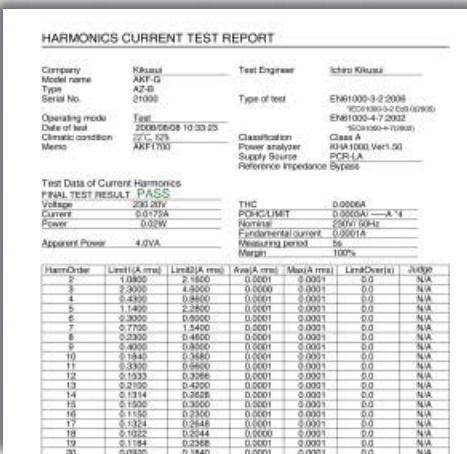

▲ Example of report creation

HA File Analyzer

HA File Analyzer is an application program that allows you to analyze the data in a test result file (xxx.hr) that you saved using HarmoCapture. The program does not require connection to KHA1000 to run, enabling you to analyze test data anywhere you want.

Screen configuration

The HA File Analyzer screen is divided into top and bottom halves consisting of three panes in total.

Result list	Lists the result files of harmonic current tests.
Graphs and data	Displays graphs representing the data of a harmonic current test result file.

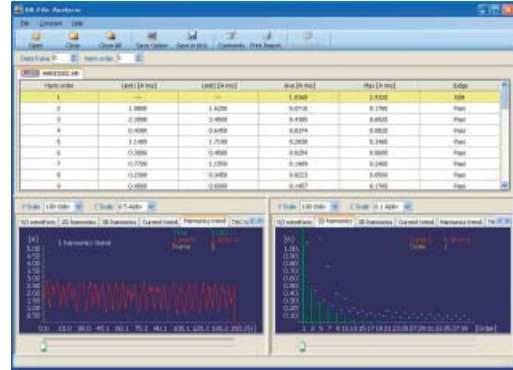

▲ Screen configuration

Repeatability check results

HA File Analyzer displays the judgment results of the files shown in the result list, as well as the judgment results for each harmonic order. Two to 15 files can be compared.

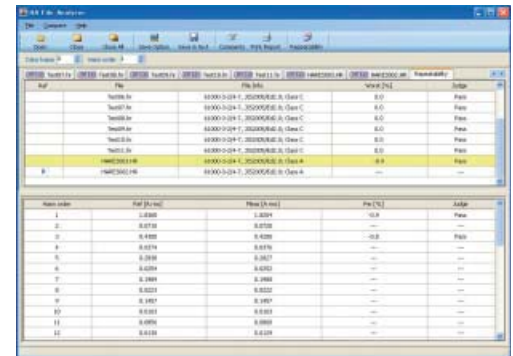

▲ Example of the repeatability check result display

Saving of test result files in text format

Test result files can be saved in text format so that they can be used with Excel and other application programs.

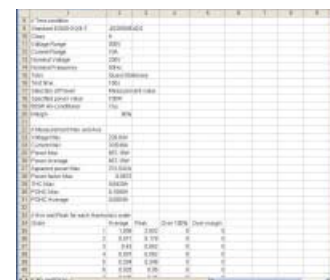

◀ Example of the Excel screen

Printing a Report of a Test Results File

The printing report function lets you generate and print reports (PDF files) from the test results files saved by the KHA1000 or HarmoCapture.

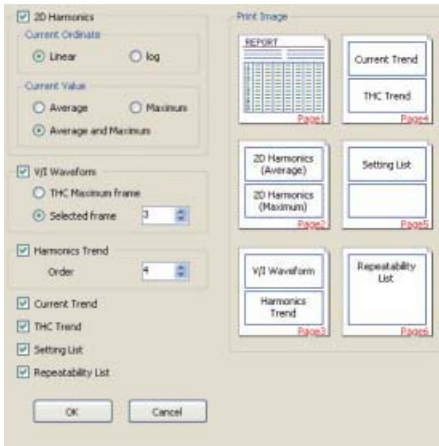

▲Setting report

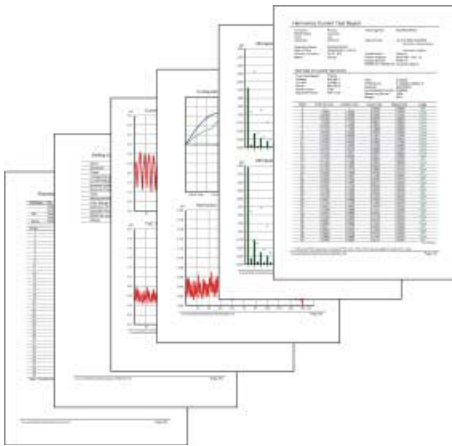

▲Printed reports of comments and test result files



▲Screen configuration

Report printing

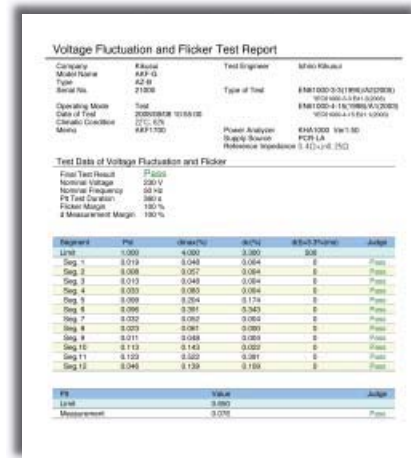

▲Example of a printed report (d measurement and simultaneous Pst and Plt measurement)

Test result list in the case of manual switching

“Voltage fluctuations arising from manual opening and closing,” as defined in Annex B of IEC61000-3-3 A1 (2001), are measured. An arithmetic average is calculated of 22 of the measurement values obtained from up to 24 measurements, excluding the maximum and minimum values, in order to judge test results.



▲Example of test results in the case of manual switching

Vf File Analyzer

Vf File Analyzer is an application program that allows you to analyze the data in a test result file (xxx.vr) that you saved using HarmoCapture. The program does not require connection to KHA1000 to run.

Screen configuration

The Vf File Analyzer screen is divided into top and bottom halves consisting of three panes in total.

Waveform over the entire measurement time	Displays the waveforms of voltage fluctuations in individual measurement time periods, each concatenated with another along the time axis.
Result/setting data list	Lists the test results and test conditions.
Segment waveforms	Provides an overlay display of the voltage fluctuation waveforms of different segments. The number of segments to be overlaid can be selected arbitrarily.

Specification

Item	Specification		
Common input specifications	Maximum input voltage	300 Vrms/560 Vpeak	
	Maximum input current	24 Arms/50 Apeak 80 Apeak (20 ms or less)	
Voltage measurement function	Rated voltage for the range	150 V, 300 V	
	Allowable crest factor	2	
	Display item	TrueRMS/±peak	
	Accuracy	± (0.4% rdng + 0.04% range)	
Current measurement function	Rated current for the range	0.5, 1, 2, 5, 10, 20A	
	Allowable crest factor	4 (0.5 A to 10 A range) 2.5 (20 A range)	
	Accuracy	± (0.5% rdng + 0.1% range) *Excluding 0.5 A range	
Power measurement function	Display item	Effective power, apparent power, reactive power, and power factor	
	Accuracy	P ≥ 150 W (±1% range), P < 150 W (±1.5 W)	
Frequency measurement function	Measured frequency range/accuracy	45 Hz to 65 Hz/ ± (0.15% rdng + 2digit)	
Harmonic current measurement function	Supported standards	IEC61000-3-2Ed3.0:2005	
		IEC61000-3-2Ed2.2:2004	
		JIS C61000-3-2:2005	
		JIS C61000-3-2:2003	
	Measuring instrument standard	IEC61000-4-7Ed2 (2002) IEC61000-4-7Ed1 (1991)	
	Number of harmonic orders analyzed	40th/180th (OTHER mode)	
	Accuracy	45 Hz to 65 Hz	± (0.5% rdng + 0.1% range) *Excluding 0.5 A range
		66 Hz to 2.4 kHz	± ((0.5 + 0.417 × nkHz) % rdng + 0.1% range)
	Handling of interharmonics	Handling on IEC61000-4-7Ed2 (2002) Handling off IEC61000-4-7Ed1 (1991)	
	Window function	Rectangular	
Window width	10 cycles/50 Hz, 12 cycles/60 Hz, or 16 cycles/ (50 or 60 Hz)		
Anti-alias filter	Cut-off frequency 6 kHz, 4th-Butterworth filter		
Class D judgment function	Current waveform inclusion rate of 95% or more (equivalent to JIS C61000-3-2:2003 Class D)		
Measurement power quality check function	Measurement items	Voltage, frequency, and voltage harmonic inclusion rate	
	Number of voltage harmonic orders analyzed	40th	
Flicker/voltage fluctuation analysis function	Supported standard	IEC61000-3-3Ed1.2: (2005)	
	Measuring instrument standard	IEC61000-4-15Ed1.1: (2003)	
	Flicker	Pst/Plt accuracy	1±5%
		Pst observation time	30 to 900 seconds
	Voltage fluctuation	Observation method	It shall be possible to choose between measuring voltage fluctuation along with Pst and measuring voltage fluctuation alone.
		Dmax measurement for manually operated equipment	3 - 24 times (one measurement period ranging from 30 to 180 seconds)
General-purpose measurement functions	Current/voltage waveform monitor, FFT analyzer, and rush current measurement		
Communication interfaces	GPIO, RS232C, USB		
External memory	Supported media	Compact flash memory card (CF card)	
External device control function	PCR-LA control (RS-232C)	Voltage, frequency, range, output on and off	
Power	Nominal voltage range	AC100 to 240 V 50/60 Hz	
Environmental conditions	Operating temperature and humidity ranges	0 to 40°C, 20 to 80%rh (no dew condensation)	
Withstand voltage	1500 VAC; one minute		
Dimensions (max.)	430 (455) W × 177 (195) H × 270 (330) Dmm		
Weight	Approx. 8 kg		
Safety	EN61010-1:2001, Class I		
EMC	IEC61326-1 A3:2003		
Accessories	Power cord, jumper connector for voltage input connection (with a dedicated screwdriver), and operation manual		

About the compact flash (CF) memory card

The CF card is to be purchased separately by the user. The maximum capacity of a CF card is 512 MB. The certified CF cards are listed below.

Type	Manufacturer name	Model name	Capacity
Compact flash memory	BUFFALO	RCF-X64M, RCF-X128M, RCF-X512M	64MB, 128MB, 512MB
	I-O DATA	CF85-128M	128MB
	SanDisk	SDCFB-128-J60	128MB
	Toshiba	CF-FA128MT	128MB
	Lexar Media	CF064-231J	64MB
	Princeton	PCF-64	64MB

Compact Flash™ is a registered trademark of SanDisk Corporation of the U.S.

Options

Multi-outlet unit

OT01-KHA

This unit allows you to connect various types of plugs used around the world.



Dedicated application software

SD005-KHA

This application lets you set test conditions and control the execution of the test. It also allows you to control the AC power supply (PCR-LA) used for the test.

[Environmental requirements]

- The OS must be Microsoft Windows Vista (Home Premium, Business, or Ultimate), Windows XP Service Pack 2 or later or Windows 2000 Service Pack 4 or later. The PC must have Internet Explorer 5.0 or later installed. ●Microsoft.NET Framework 2.0 ●Memory space of 256 MB or more ●XGA or higher resolution ●Free hard disk space of 100 MB or more ●CD-ROM drive ●Mouse or other pointing device ●VISA library (NI-VISA 3.3.0 or later, Agilent I/O Libraries Suite 14.1 or later, or KI-VISA 3.0.4 or later) ●USB cable (only when the USB interface is used)

Ethernet port

[Factory-set option] * Specify when ordering.

You can print on the network printer directly from this device. This is useful when you build a harmonic test system without the use of a PC.

Rack mount bracket

[For KHA1000]

KRB4 (inch size)

KRB200 (millimeter size)

[For OT01-KHA]

KRB2-TOS (inch size)

KRB100-TOS (millimeter size)

Signal Test, Inc
1529 Santiago Ridge Way
San Diego, CA 92154
Tel. 1-619-575-1577 USA
www.SignalTestInc.com
Sales@SignalTestInc.com

