

Arbitrary Function Generator

AFG-3021, 3022, 3031 & AFG-3032

USER MANUAL

GW INSTEK PART NO. 82FG-30320E01



ISO-9001 CERTIFIED MANUFACTURER

GW INSTEK

February 2016 edition

This manual contains proprietary information, which is protected by copyright. All rights are reserved. No part of this manual may be photocopied, reproduced or translated to another language without prior written consent of Good Will Corporation.

The information in this manual was correct at the time of printing. However, Good Will continues to improve its products and therefore reserves the right to change the specifications, equipment, and maintenance procedures at any time without notice.

Good Will Instrument Co., Ltd.
No. 7-1, Jhongsing Rd., Tucheng City, Taipei County 236, Taiwan.

Table of Contents

S	SAFETY INSTRUCTIONS	6
G	GETTING STARTED	12
	Main Features	12
	Panel Overview.....	15
	Setting up the Function Generator	24
Q	QUICK REFERENCE	26
	How to use the Digital Inputs	28
	How to use the Help Menu	29
	Selecting a Waveform	32
	Modulation.....	36
	Sweep.....	42
	Burst	43
	ARB	44
	Utility Menu	48
	Menu Tree	51
	Default Settings	68
O	OPERATION	70
	Select a Channel.....	71
	Select a Waveform	72
M	MODULATION	89
	Amplitude Modulation (AM)	91
	Frequency Modulation (FM)	100
	Frequency Shift Keying (FSK) Modulation	108
	Phase Modulation (PM)	115
	SUM Modulation	121
	Pulse Width Modulation	128
	Sweep.....	135

Burst Mode	146
------------------	-----

SECONDARY SYSTEM FUNCTION SETTINGS

158

Save, Recall or Delete	159
Selecting the Remote Interface	163
System and Settings	168

DUAL CHANNEL & MULTI-UNIT OPERATION

177

Dual Channel Settings	178
Multi-Unit Syncing	186

ARBITRARY WAVEFORMS

190

Inserting Built-In Waveforms	191
Display an Arbitrary Waveform	198
Editing an Arbitrary Waveform	205
Output an Arbitrary Waveform	214
Saving/Loading an Arbitrary Waveform	221

REMOTE INTERFACE

229

Establishing a Remote Connection	230
Web Browser Control Interface	237
Command Syntax	240
Command List	245
488.2 Common Commands	251
Status Register Commands	254
System Commands	260
Apply Commands	263
Output Commands	271
Pulse Configuration Commands	281
Harmonic Commands	284
Amplitude Modulation (AM) Commands	288
AM Overview	288

Frequency Modulation (FM) Commands	293
FM Overview	293
Frequency-Shift Keying (FSK) Commands	298
FSK Overview	298
Phase Modulation (PM) Commands	302
PM Overview	302
Additive Modulation (SUM) Commands	306
SUM Overview.....	306
Pulse Width Modulation (PWM) Commands	311
PWM Overview	311
Frequency Sweep Commands	316
Sweep Overview	316
Burst Mode Commands.....	327
Burst Mode Overview	327
Arbitrary Waveform Commands	337
Arbitrary Waveform Overview	337
Tracking Commands	378
Reference Commands.....	383
Save and Recall Commands	384
Error Messages	386
SCPI Status Registers	399
APPENDIX.....	405
Fuse Replacement	405
AFG-3021, AFG-3022, AFG-3031 & AFG-3032 Specifications	406
EC Declaration of Conformity	413
ARB Built-In Waveforms	414
INDEX.....	422

S SAFETY INSTRUCTIONS

This chapter contains important safety instructions that should be followed when operating and storing the function generator. Read the following before any operation to ensure your safety and to keep the function generator in the best condition.

Safety Symbols

These safety symbols may appear in this manual or on the instrument.



WARNING

Warning: Identifies conditions or practices that could result in injury or loss of life.



CAUTION

Caution: Identifies conditions or practices that could result in damage to the function generator or to other objects or property.



DANGER High Voltage



Attention: Refer to the Manual



Signal ground. Chassis ground



Signal ground. Isolated from other channels and ground.



Do not dispose electronic equipment as unsorted municipal waste. Please use a separate collection facility or contact the supplier from which this instrument was purchased.

Safety Guidelines

General Guideline





CAUTION

- Do not place heavy objects on the instrument.
- Do not place flammable objects on the instrument.
- Avoid severe impact or rough handling that may damage the function generator.
- Avoid discharges of static electricity on or near the function generator.
- Use only mating connectors, not bare wires, for the terminals.
- The instrument should only be disassembled by a qualified technician.
- Do not apply more than 42Vpk to any input/output ground or to the chassis ground.
- Do not apply voltage to the output terminals to avoid damage to the instrument.
- Do not apply more than $\pm 5V$ to the trigger or MOD input terminals to avoid damage to the instrument.

(Measurement categories) EN 61010-1:2010 specifies the measurement categories and their requirements as follows. The AFG-30XX falls under category II.

- Measurement category IV is for measurement performed at the source of a low-voltage installation.
- Measurement category III is for measurement performed in a building installation.
- Measurement category II is for measurement performed on circuits directly connected to a low voltage installation.
- Measurement category I is for measurements performed on circuits not directly connected to Mains.

-
- | | |
|--------------|-----------------------------------------------------------------------------------------------|
| Power Supply | <ul style="list-style-type: none">• AC Input voltage: 100 - 240V AC, 50 - 60Hz. |
|--------------|-----------------------------------------------------------------------------------------------|
-
- | | |
|-------------------------------------------------------------------------------------------|-----------------------------------------------------------------------------------------------------------------------------------------------------------------|
|  WARNING | <ul style="list-style-type: none">• Connect the protective grounding conductor of the AC power cord to an earth ground to prevent electric shock. |
|-------------------------------------------------------------------------------------------|-----------------------------------------------------------------------------------------------------------------------------------------------------------------|
-
- | | |
|------|----------------------------------------------------------------------------------------------------------------------------------------------------------------------------------------------------------------------------------------------------------------------------------------------------------------------------------------------------------------------------------------------------------------------------------------------------------------------|
| Fuse | <ul style="list-style-type: none">• Fuse type:
AFG-3032&3022: T1A/250V
AFG-3031&3021: T0.63A/250V• Only qualified technicians should replace the fuse.• To ensure fire protection, replace the fuse only with the specified type and rating.• Disconnect the power cord and all test leads before replacing the fuse.• Make sure the cause of the fuse blowout is fixed before replacing the fuse. |
|------|----------------------------------------------------------------------------------------------------------------------------------------------------------------------------------------------------------------------------------------------------------------------------------------------------------------------------------------------------------------------------------------------------------------------------------------------------------------------|
-
- | | |
|--------|-----------------------------------------------------------------------------------------------------------------------------------------------------------------------------------------------------------------------------------------------------------------------------------------------------------------------------------------------------------------------------------------------------------------------------------------------------------------------------------------------------------------------------------------------------------------------------------------------------------------------------------------------------------------------|
| Ground | <ul style="list-style-type: none">• The AFG-30XX is a floating function generator; the AFG-30XXs' common ground is electrically isolated from the chassis ground by a 42Vpk isolation voltage (DC + peak AC). Exceeding 42Vpp may cause damage to the internal circuits.• Do not short the chassis ground with CH1(MAIN)'s or CH2's common ground if there is a potential voltage difference between them. Doing so may damage the unit or externally connected equipment.• If there is a potential voltage between CH1's and CH2's common ground, do not short them. Doing so may damage the unit or externally connected equipment. |
|--------|-----------------------------------------------------------------------------------------------------------------------------------------------------------------------------------------------------------------------------------------------------------------------------------------------------------------------------------------------------------------------------------------------------------------------------------------------------------------------------------------------------------------------------------------------------------------------------------------------------------------------------------------------------------------------|
-
- | | |
|---------------------------------------------------------------------------------------------|----------------------------------------------------------------------------------------------------------------------------------------------------------------------------------------------------------------------------------------------|
|  WARNING | <ul style="list-style-type: none">• To avoid electric shock ensure that the output voltage and floating voltage does not exceed 42Vpk in total.• Do not touch any exposed connectors when the unit is being operated. |
|---------------------------------------------------------------------------------------------|----------------------------------------------------------------------------------------------------------------------------------------------------------------------------------------------------------------------------------------------|
-
- 8

- Cleaning the function generator
- Disconnect the power cord before cleaning the function generator.
 - Use a soft cloth dampened in a solution of mild detergent and water. Do not spray any liquid into the function generator.
 - Do not use chemicals containing harsh products such as benzene, toluene, xylene, and acetone.
-

- Operation Environment
- Location: Indoor, no direct sunlight, dust free, almost non-conductive pollution (Note below) and avoid strong magnetic fields.
 - Relative Humidity: < 80%
 - Altitude: < 2000m
 - Temperature: 0°C to 40°C
- (Pollution Degree) EN 61010-1:2010 specifies pollution degrees and their requirements as follows. The function generator falls under degree 2.
- Pollution refers to “addition of foreign matter, solid, liquid, or gaseous (ionized gases), that may produce a reduction of dielectric strength or surface resistivity”.
- Pollution degree 1: No pollution or only dry, non-conductive pollution occurs. The pollution has no influence.
 - Pollution degree 2: Normally only non-conductive pollution occurs. Occasionally, however, a temporary conductivity caused by condensation must be expected.
 - Pollution degree 3: Conductive pollution occurs, or dry, non-conductive pollution occurs which becomes conductive due to condensation which is expected. In such conditions, equipment is normally protected against exposure to direct sunlight, precipitation, and full wind pressure, but neither temperature nor humidity is controlled.
-

- Storage environment
- Location: Indoor
 - Relative Humidity: < 70%
 - Temperature: -10°C to 70°C
-

Disposal

Do not dispose this instrument as unsorted municipal waste. Please use a separate collection facility or contact the supplier from which this instrument was purchased. Please make sure discarded electrical waste is properly recycled to reduce environmental impact.

Class A Device**WARNING**

The AFG-30XX function generators are categorized as Class A equipment. Class A equipment is intended for use in an industrial environment. Class A equipment may have potential difficulties in ensuring electromagnetic compatibility in other environments, due to conducted as well as radiated disturbances.

Power cord for the United Kingdom

When using the function generator in the United Kingdom, make sure the power cord meets the following safety instructions.

NOTE: This lead/appliance must only be wired by competent persons



WARNING: THIS APPLIANCE MUST BE EARTHED

IMPORTANT: The wires in this lead are coloured in accordance with the following code:

Green/ Yellow: Earth
Blue: Neutral
Brown: Live (Phase)



As the colours of the wires in main leads may not correspond with the coloured marking identified in your plug/appliance, proceed as follows:

The wire which is coloured Green & Yellow must be connected to the Earth terminal marked with either the letter E, the earth symbol \oplus or coloured Green/Green & Yellow.

The wire which is coloured Blue must be connected to the terminal which is marked with the letter N or coloured Blue or Black.

The wire which is coloured Brown must be connected to the terminal marked with the letter L or P or coloured Brown or Red.

If in doubt, consult the instructions provided with the equipment or contact the supplier.

This cable/appliance should be protected by a suitably rated and approved HBC mains fuse: refer to the rating information on the equipment and/or user instructions for details. As a guide, a cable of 0.75mm² should be protected by a 3A or 5A fuse. Larger conductors would normally require 13A types, depending on the connection method used.

Any exposed wiring from a cable, plug/ connection that is engaged in a live socket is extremely hazardous. If a cable or plug is deemed hazardous, turn off the mains power and remove the cable, any fuses and fuse assemblies. All hazardous wiring must be immediately destroyed and replaced in accordance to the above standard.

GETTING STARTED

The Getting started chapter introduces the function generator's main features, appearance, set up procedure and power-up.

Note: Throughout this manual, "AFG-30XX" refers to the AFG-3021, AFG-3022, AFG-3031 & AFG-3032, unless stated otherwise.

Main Features

Model name	Frequency bandwidth	Channels
AFG-3021	20MHz	1 (signal ground chassis isolation)
AFG-3022	20MHz	2 (signal ground chassis isolation and channel isolation)
AFG-3031	30MHz	1 (signal ground chassis isolation)
AFG-3032	30MHz	2 (signal ground chassis isolation and channel isolation)

- Performance
- DDS Function Generator series
 - 1 μ Hz high frequency resolution maintained at full range
 - 1ppm frequency stability
 - Full Function Arbitrary Waveform Capability
 - 250 MSa/s sample rate
 - 125 MSa/s repetition rate
 - 8 M-point waveform length
 - 16-bit amplitude resolution

-
- Ten 8 M waveform memories
 - True waveform output to display
 - User define output section
 - D W R (Direct Waveform Reconstruction) capability
 - Waveform editing capability sans PC
 - N Cycle and Infinite output mode selectable
 - -60dBc low distortion sine wave
-

Features

- Sine, Square, Triangle, Pulse, Ramp, Noise, DC standard waveforms
 - Int/Ext AM, FM, PWM, FSK, PM, SUM modulation
 - Modulation/sweep signal output
 - Burst function with internal and external triggers
 - Store/recall 10 groups of setting memories
 - Output overload protection
 - Two channel tracking (AFG-3022/3032 only)
 - 42Vpk signal ground chassis isolation and 42Vpk channel isolation
 - Multi-unit synchronized control
 - DSO Link function to transfer captured waveforms from the DSO to the function generator
 - Harmonic waveform function
 - Pulse waveform with configurable rise times & fall times
 - Frequency and amplitude sweep
-

Interface

- Interface: Standard: LAN, USB Optional: GPIB
- 4.3 inch color TFT LCD (480 × 272) Graphical User Interface
- AWES (Arbitrary Waveform Editing Software) PC software





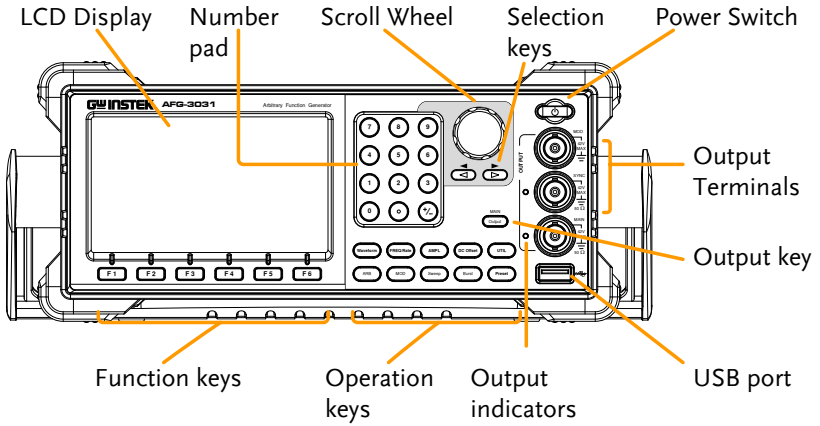

Panel Overview

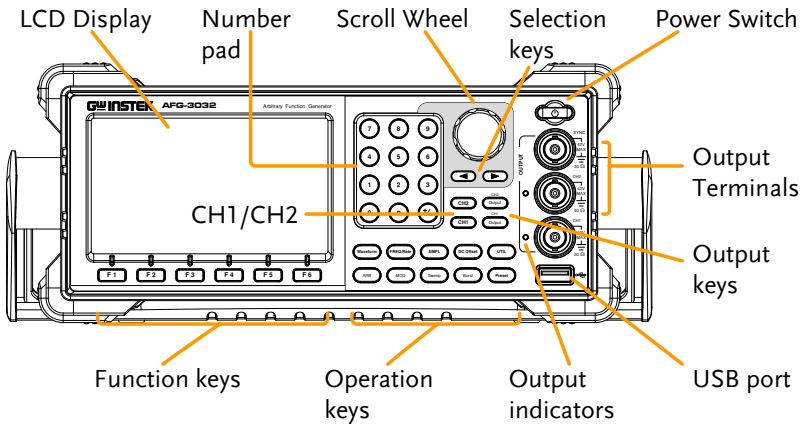
Front Panel AFG-3021/3031

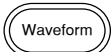
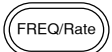
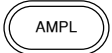
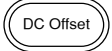

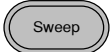
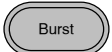

AFG-3022/3032



LCD display	TFT color LCD display, 480 x 272 resolution.	
Function keys: F1~F6		Activates the functions which appear in the bottom of the LCD display.
Operation keys		Waveform is used to select a waveform type.
		The FREQ/Rate key is used to set the frequency or sample rate.
		AMPL sets the waveform amplitude.
		Sets the DC offset.
		The UTIL key is used to access the save and recall options, set the remote interface (USB, GPIB, LAN), use DSO link (AFG-3021/3031), update and view the firmware version, access the calibration options, output impedance settings (AFG-3021/3031 only), set the language and access the help menu.
		ARB is used to set the arbitrary waveform parameters.
		The MOD, Sweep and Burst keys are used to set the modulation, sweep and burst settings and parameters.
		
		
	Preset	

<p>Main Output (AFG-3021/3031)</p>		<p>The Output key is used to turn on or off the waveform output.</p>
----------------------------------------	-----------------------------------------------------------------------------------	----------------------------------------------------------------------

<p>CH1/CH2 Output (AFG-3022/3032)</p>		<p>CH1/CH2 Output key. These keys are used to turn the output on or off for each individual channel.</p>
-----------------------------------------------	-----------------------------------------------------------------------------------	----------------------------------------------------------------------------------------------------------

<p>CH1/CH2 (AFG-3022/3032)</p>		<p>The CH1/CH2 keys are used to access the DSO link function, output impedance settings and phase settings for the AFG-3022 & AFG-3032.</p>
------------------------------------	-----------------------------------------------------------------------------------	-------------------------------------------------------------------------------------------------------------------------------------------------

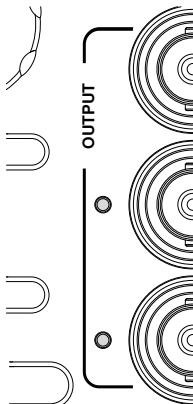
<p>Output indicators</p>		<p>When an Output indicator is green, it indicates that the output is active.</p>
--------------------------	-----------------------------------------------------------------------------------	-----------------------------------------------------------------------------------

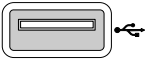
<p>USB host connector</p>		<p>The USB Host connector is used to save and restore data as well as update the firmware.</p>
---------------------------	------------------------------------------------------------------------------------	------------------------------------------------------------------------------------------------

Output terminals
(AFG-3021/3031)

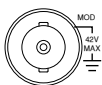

Modulation output terminal for the AM, FM, PWM, PM, SUM or sweep function.

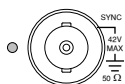

The SYNC output terminal outputs a TTL logic level signal in phase with the zero phase position of the main output. 50Ω output impedance.

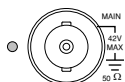

The primary output terminal. 50Ω output impedance.

Note: The MAIN ground has a common ground with the MOD output, SYNC and MOD input terminals. They are also isolated from the chassis ground and the 10MHz REF IN ground by an isolation voltage of 42Vpk.

Output terminals
(AFG-3022/3032)

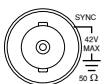

The SYNC output terminal outputs a TTL logic level signal in phase with the zero phase position of the CH1 output. 50Ω output impedance.

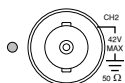

CH2 output terminal. 50Ω output impedance.





CH1 output terminal. 50Ω output impedance.

Note: The CH1, CH2 and 10MHz REF IN ground are isolated from each other and from the chassis ground by an isolation voltage of 42Vpk.

The CH1 ground has a common ground with the MOD output, SYNC and the CH1 MOD input terminals.

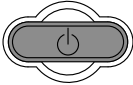
The CH2 ground has a common ground with the CH2 MOD input terminal.

Standby key  The standby key is used to turn the function generator on (green) or to put the function generator into standby mode (red).

Selection keys  Used to select digits when editing parameters.

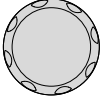
Scroll Wheel  The scroll wheel is used to edit values and parameters.

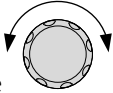

Decrease Increase

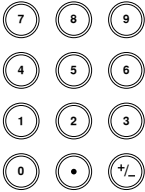
Keypad  The digital keypad is used to enter values and parameters. The keypad is often used in conjunction with the selection keys and variable knob.

Rear Panel

AFG-3021/3031

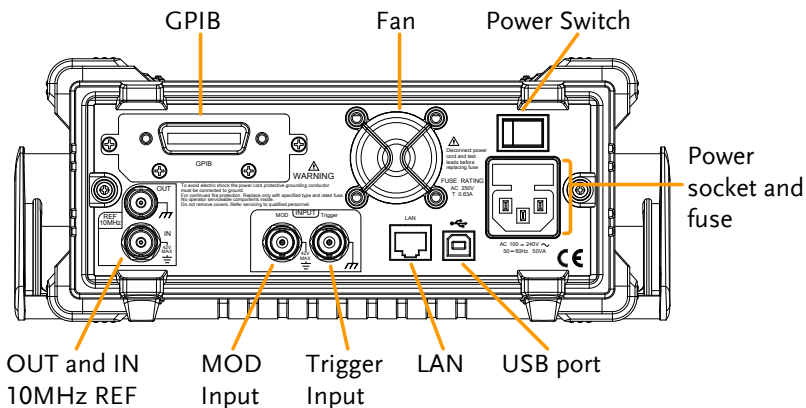

AFG-3022/3032

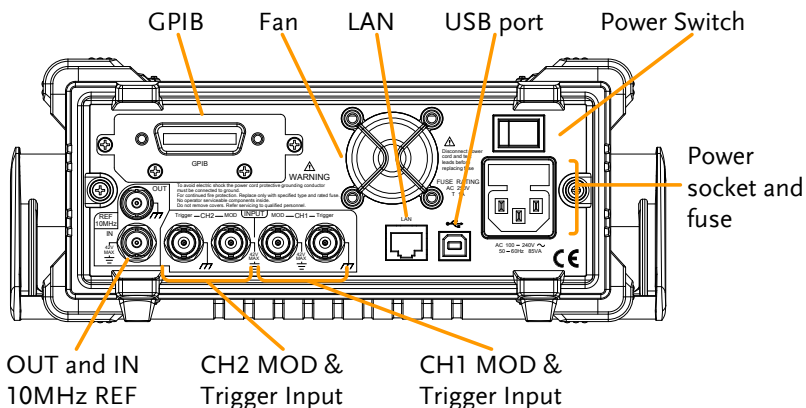

10MHz REF OUT

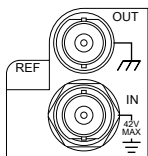

10 MHz reference output.

10MHz REF IN

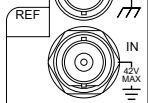

10 MHz reference input.

Trigger Input

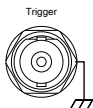

External trigger input. Used to receive external trigger signals. For the AFG-3022/3032 there is a separate trigger input for CH1 and CH2.

MOD input

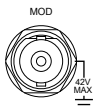

Modulation input terminal. For the AFG-3022/3032 there is a separate modulation input for CH1 and CH2.

Note: The CH1/CH2 MOD input terminals are isolated from each other and from the chassis ground by an isolation voltage of 42Vpk.

The CH1 MOD input shares ground with the CH1 ground.

The CH2 MOD input shares ground with the CH2 ground.

Fan

Power Socket
Input and fuse

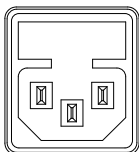

Power input: 100-240V AC
50-60Hz.

Fuse:
AFG-3022/3032: T1A/250V
AFG-3021/ AFG-3031: T0.63A/250V
For the fuse replacement procedure,
see page 405.

Power Switch



Main power switch.

USB B port



The USB B connector is used to connect the function generator to a PC for remote control.

LAN port



Ethernet port used for remote control (RJ45 connector).

GPIB

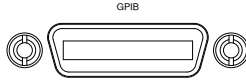

24 pin female GPIB
connector for PC remote
control.

Display

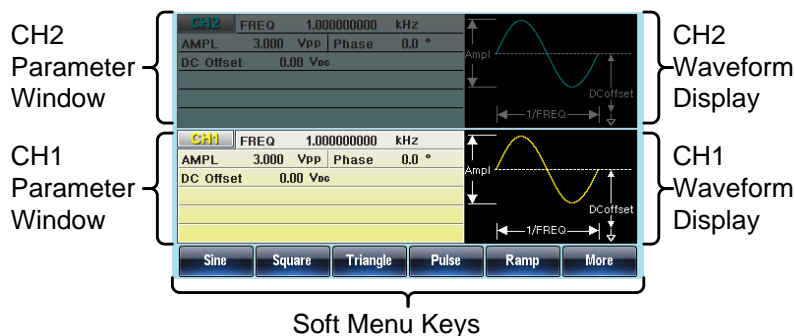

Parameter Windows These windows are used to edit the parameter values for CH1 and CH2.

Waveform Display The Waveform Display is used give an indication of the expected waveform output for each channel.

Soft Menu Keys The function keys (F1~F6) below the Soft Menu keys correspond to the soft keys.

Setting up the Function Generator

Background

This section describes how to adjust the handle and power up the function generator.

Adjusting the stand

Pull out the handle sideways and rotate it.

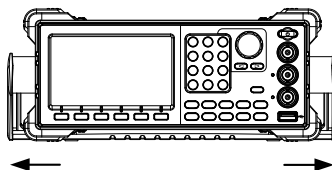

Place the unit horizontally,

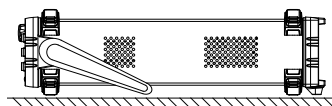

or tilt the stand.

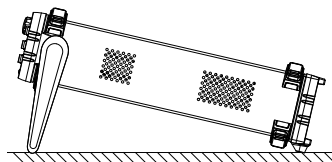

Place the handle vertically to hand carry.

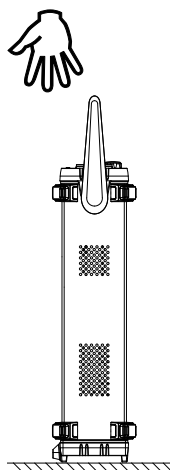

Power Up

1. Connect the power cord to the socket on the rear panel.

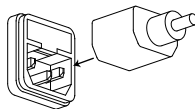

2. Turn on the power switch on the rear panel.



3. Press and hold the Standby key on the front panel to turn the machine on. The standby key will change from red (standby) to green (on).



Standby On

4. When the standby key turns green, the instrument will turn on showing a loading screen.



The function generator is now ready to be used.

QUICK REFERENCE

This chapter lists operation shortcuts, built-in help coverage, and default factory settings. Use this chapter as a quick reference for instrument functions. For detailed explanations on parameters, settings and limitations, please see the Operation chapter (page 70), Modulation chapter (page 89), Secondary System Function Settings chapter (page 158), Dual Channel & Multi-Unit Operation chapter (page 177) or the Specifications (page 406).

How to use the Digital Inputs	28
How to use the Help Menu	29
Selecting a Waveform	32
Square Wave	32
Triangle Wave	32
Sine Wave	33
Pulse Wave	33
Noise Wave	34
Harmonic Wave	34
Modulation	36
AM	36
FM	37
FSK Modulation	38
PM	39
SUM Modulation	40
PWM Modulation	41
Sweep	42
Burst	43
ARB	44
ARB – Add Built-In Waveform	44
ARB – Add Built-In Waveform - Pulse	44
ARB - Add Point	45
ARB - Add Line	45
ARB – Output Section	46
ARB – Output N Cycle	46
ARB – Output Infinite Cycles	47

Utility Menu	48
Save	48
Recall	48
Interface GPIB	48
Interface LAN	49
Interface USB	49
Dual Channel – Frequency Coupling	49
Dual Channel – Amplitude Coupling	49
Dual Channel – Tracking	50
Menu Tree	51
Waveform	51
Waveform - Pulse	52
Waveform - More	52
ARB-Display	53
ARB-Edit	54
ARB-Built-in	55
ARB-Built in-Basic	56
ARB-Save	57
ARB-Load	57
ARB-Output	58
MOD	59
Sweep - Type/MOD = Frequency	60
Sweep - More	60
Sweep - Type/MOD = Amplitude	61
Burst – N Cycle	62
Burst - Gate	62
CH1 / CH2 (AFG-3022/AFG-3032 Only)	63
UTIL (AFG-3021/3031)	63
UTIL (AFG-3022/AFG-3032)	64
UTIL - Interface	64
UTIL - Interface - LAN	65
UTIL - Interface - LAN - Config - Manual	66
UTIL - System	66
UTIL - Dual Channel	67
Default Settings	68

How to use the Digital Inputs

Background

The AFG-30XX has three main types of digital inputs: the number pad, selection keys and scroll wheel. The following instructions will show you how to use the digital inputs to edit parameters.

1. To select a menu item, press the corresponding function keys below (F1~F6). In the example below, the F1 function key corresponds to the Soft key "Sine".



2. To edit a digital value, use the selector key to move the cursor to the digit that needs to be edited.



3. Use the scroll wheel to edit the digit under the cursor. Clockwise increases the value, counterclockwise decreases the value.

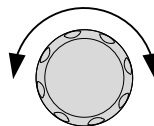

4. Alternatively, the number pad can be used to set the value of a highlighted parameter.

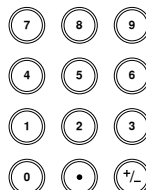

How to use the Help Menu

Background Every key and function has a detailed description in the help menu.

1. Press UTIL.



2. Press System (F4)[F5 for the AFG-3021/3031].



3. Press More (F5).



4. Press Help (F2).



5. Use the scroll wheel to navigate to a help item. Press Select to choose the item.

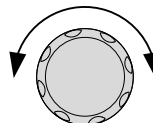

Keypad Provides help on any front panel key that is pressed.

Arbitrary Waveform Explains how to create arbitrary waveforms.

Modulation Function	Explains how to create Modulated waveforms.
Sweep Function	Provides help on the Sweep function.
Burst Function	Provides help on the Burst function.
DSO Link	Provides help on DSO link.
Hardcopy	Explains how to use the Hardcopy function.
Dual Channel	Describes how to perform frequency or amplitude tracking for the AFG-3022/3032.

6. For example select item 5 to see help on the sweep function.



7. Use the scroll wheel to navigate to each help page.

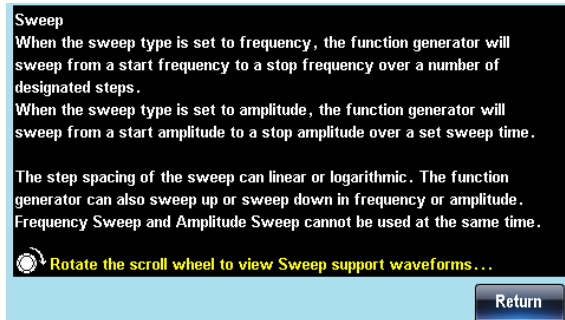

8. Press F6 to return to the previous menus.



Selecting a Waveform

Square Wave

Example: Square wave, 3Vpp, 75% duty, 1 kHz

Output

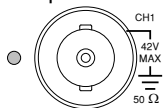

1. Press the Waveform key and select Square (F2).



2. Press Duty (F1), followed by 7 + 5 + % (F5)



Input: N/A

3. Press the FREQ/Rate key, followed by 1 + kHz (F5).



4. Press the AMPL key, followed by 3 + VPP (F6).



5. Press the output key.



Triangle Wave

Example: Triangle wave, 5Vpp, 10kHz

Output

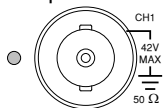

1. Press the Waveform key and select Triangle (F3).



2. Press the FREQ/Rate key, followed by 1 + 0 + kHz (F5).



Input: N/A

3. Press the AMPL key, followed by 5 +VPP (F6).



4. Press the output key.



Sine Wave

Example: Sine wave, 10Vpp, 100kHz

Output

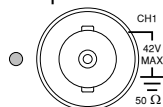

Input: N/A

1. Press the Waveform key and select Sine (F1).



2. Press the FREQ/Rate key, followed by 1 + 0 + 0 + kHz (F5).

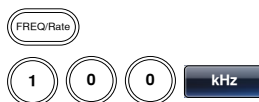

3. Press the AMPL key, followed by 1 + 0 + VPP (F6).



4. Press the output key.



Pulse Wave

Example: Pulse wave, 10Vpp, 100kHz, 5us pulse width

Output

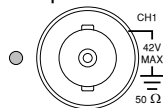





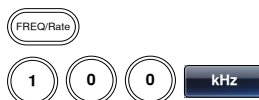



Input: N/A

1. Press the FREQ/Rate key, followed by 1 + 0 + 0 + kHz (F5).







2. Press the Waveform key and select Pulse (F4).



3. Press Width (F1),    followed by 5 + uSEC (F3).
4. Press the AMPL key,     followed by 1 + 0 +VPP (F6).
5. Press the output key. 

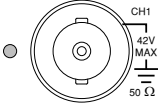







Noise Wave

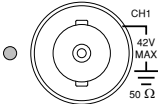



















Example: White noise output

- Output 
1. Press the Waveform key and select More (F6), Noise (F1).   
 2. Press the output key. 
- Input: N/A

Harmonic Wave

Example: 10kHz harmonic sine wave, odd & even (all) harmonics, up to the 3rd order (2nd(5Vpp), 3rd(2Vpp), 0° phase).

- Output 
1. Press the Waveform key and select More (F6), Harmonic (F2).   
 2. Press Total (F1),    followed by 3 + Enter (F1).
 3. Press Type (F2), ALL (F3).  
- Input: N/A

4. Press Order (F3). 
5. Press Order (F1), followed by 2 + Enter (F1).   
- Press Amp(F2), followed by 5 + VPP (F2).   
- Press Phase(F3), followed by 0 + Degree (F1).   
6. Press the Order (F1), followed by 3 + Enter (F1).   
- Press Amp(F2), followed by 2 + VPP (F2).   
- Press Phase(F3), followed by 0 + Degree (F1).   
7. Press the output key. 

Modulation

AM

Example: AM modulation. 100Hz modulating square wave. 1kHz Sine wave carrier. 80% modulation depth.

Output

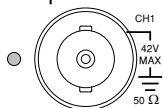

1. Press the MOD key and select AM (F1).



2. Press Waveform and select Sine (F1).



Input: N/A

3. Press the Freq/Rate key, followed by 1 + kHz (F5).



4. Press the MOD key, select AM (F1), Shape (F4), Square (F2).



5. Press the MOD key, select AM (F1), AM Freq (F3).



6. Press 1 + 0 + 0 + Hz (F2).





7. Press the MOD key, select AM (F1), Depth (F2).



8. Press 8 + 0 + % (F1).



9. Press MOD, AM (F1), Source (F1), INT (F1).
 
10. Press the output key.
 





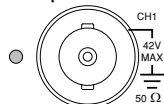

FM



Example: FM modulation. 100Hz modulating square wave. 1kHz sine wave carrier. 100 Hz frequency deviation. Internal source.

Output

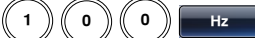

Input: N/A

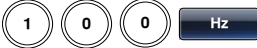
1. Press the MOD key and select FM (F2).
 
2. Press Waveform and select Sine (F1).
 
3. Press the Freq/Rate key, followed by 1 + kHz (F5).
 
4. Press the MOD key, select FM (F2), Shape (F4), Square (F2).
 
5. Press the MOD key, select FM (F2), FM Freq (F3).
 
6. Press 1 + 0 + 0 + Hz (F2).
 
7. Press the MOD key, select FM (F2), Freq Dev (F2).
 





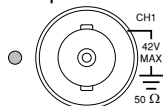

8. Press 1 + 0 + 0 + Hz (F3). 
9. Press MOD, FM (F2), Source (F1), INT (F1). 
10. Press the output key. 

FSK Modulation



Example: FSK modulation. 100Hz hop frequency. 1kHz carrier wave. Triangle wave. 10 Hz rate. Internal source.

Output

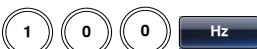

1. Press the MOD key and select FSK (F3). 
2. Press Waveform and select Triangle (F3). 
3. Press the Freq/Rate key, followed by 1 + kHz (F5). 
4. Press the MOD key, select FSK (F3), FSK Rate (F3). 
5. Press 1 + 0 + Hz (F2). 
6. Press the MOD key, select FSK (F3), Hop Freq (F2). 
7. Press 1 + 0 + 0 + Hz (F3). 

Input: N/A

8. Press MOD, FSK (F3), Source (F1), INT (F1).
 
9. Press the output key.
 





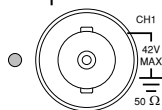

PM

Example: PM modulation. 100Hz phase frequency. Sine wave shape. 180° phase deviation. 1kHz sine wave carrier.

Output



Input: N/A

1. Press the MOD key and select PM (F4).
 
2. Press Waveform and select Sine (F1).
 
3. Press the Freq/Rate key, followed by 1 + kHz (F5).
 
4. Press the MOD key, select PM (F4), Shape (F4), Sine (F1).
 
5. Press the MOD key, select PM (F4), PM Freq (F3).
 
6. Press 1 + 0 + 0 + Hz (F2).
 
7. Press the MOD key, select PM (F4), Phase Dev (F2).
 



8. Press 1 + 8 + 0 + Degree (F1).    

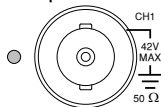

SUM Modulation

Example: SUM modulation. 100Hz SUM frequency. 50% SUM amplitude. 1kHz carrier sine wave. Triangle wave shape. Internal source.



Output







1. Press the MOD key and select SUM (F5).  

2. Press Waveform and select Sine (F1).  



Input: N/A





3. Press the Freq/Rate key, followed by 1 + kHz (F5).   



4. Press the MOD key, select SUM (F5), SUM Freq (F3).   

5. Press 1 + 0 + 0 + Hz (F2).    

6. Press the MOD key, select SUM (F5), SUM Ampl (F2).   

7. Press 5 + 0 + % (F1).   

8. Press the MOD key, select SUM (F5), Shape (F4), Triangle (F3).   

9. Press MOD, SUM (F5), Source (F1), INT (F1).
 
10. Press the output key.
 





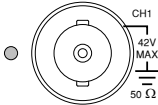

PWM Modulation

Example: PWM modulation. 800Hz carrier wave. 15 kHz modulating sine wave. 50% duty cycle. Internal source.

Output

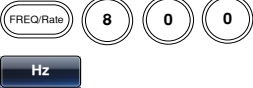

Input: N/A

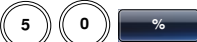
1. Press Waveform and select Square (F2).
 
2. Press the MOD key and select PWM (F6).
 
3. Press the FREQ/Rate key, followed by 8 + 0 + 0 + Hz (F4).
 
4. Press the MOD key, select PWM (F6), Shape (F4), Sine (F1).
 
5. Press the MOD key, PWM (F6), PWM Freq (F3).
 
6. Press 1 + 5 + kHz (F3).
 
7. Press MOD, PWM (F6), Duty (F2).
 
8. Press 5 + 0 + % (F1).
 

9. Press MOD, PWM (F6), Source (F1), INT (F1).

MOD PWM Source
INT

10. Press the output key.

Output

Sweep

Example: Frequency sweep. Start frequency 10mHz, stop frequency 1MHz. Log sweep, 1 second sweep, manual trigger.

Output

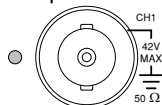

1. Press Sweep, Start (F3).

Sweep Start

2. Press 1 + 0 + mHz (F2).

1 0 mHz

3. Press Sweep, Stop (F4).

Sweep Stop

Input: N/A

4. Press 1 + MHz (F5).

1 MHz

5. Press Sweep, Type/MOD (F2), Functions (F3), Log (F2).

Sweep Type/MOD Functions
Log

6. Press Sweep, SWP Time (F5).

Sweep SWP Time

7. Press 1 + SEC (F2).

1 SEC

8. Press Sweep, TRIG Type (F6), Manual (F3).

Sweep TRIG Type Manual

9. Press the output key. 



10. Press Trigger (F1). 

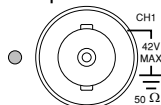

Burst

Example: Burst mode, N-Cycle (Internally triggered), 1kHz burst frequency, burst count = 5, 10 ms burst period, 0° burst phase, internal trigger, 10 us delay.



Output







1. Press **FREQ/Rate** 1 kHz (F5).   



2. Press **Burst, N Cycle** (F1), **Cycles** (F1).   

Input: N/A

3. Press **5 + Cyc** (F5).  

4. Press **Burst, N Cycle** (F1), **Period** (F4).   

5. Press **1 + 0 + msec** (F2).   

6. Press **Burst, N Cycle** (F1), **Phase** (F3).   

7. Press **0 + Degree** (F5).  

8. Press **Burst, N Cycle** (F1), **TRIG Setup** (F5), **INT** (F1).   

9. Press Burst, N Cycle (F1), TRIG Setup (F5), Delay (F4).

Burst
N Cycle
Trig Setup

Delay

10. Press 1 + 0 + uSEC (F2).

1
0
uSEC

11. Press the output key.

Output

ARB

ARB – Add Built-In Waveform

Example: ARB Mode, exponential rise. Start 0, length 100, scale 32767.

Output

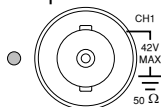

1. Press ARB, Built in (F3), Basic (F1), More (F5), Exp Rise (F1).

ARB
Built in
Basic

More
Exp Rise

2. Press Start (F1), 0 + Enter (F5).

Start
0
Enter

3. Press Length (F2), 100, Enter (F5).

Length
1
0
0

Enter

4. Press Scale (F3), 32767, Enter (F5), Done (F4).

Scale
3
2
7

6
7
Enter
Done

ARB – Add Built-In Waveform - Pulse

Example: ARB Mode, Pulse. Start 0, Frequency 1kHz, Duty 25%.

Output

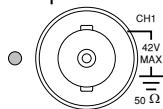

1. Press ARB, Built in (F3), Basic (F1), More (F5), Pulse (F4).



2. Press Frequency (F1), 1, kHz (F5).



3. Press Duty (F2), 25, % (F5).



ARB - Add Point

Example: ARB Mode, Add point, Address 40, data 30,000.

Output

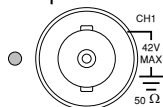

1. Press ARB, Edit (F2), Point (F1), Address (F1).



2. Press 4 + 0 + Enter (F5).



3. Press Data (F2), 3+0+0+0+0, Enter (F5).



ARB - Add Line

Example: ARB Mode, add line, address: data (10:30, 50:100)

Output

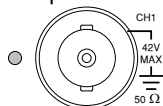

1. Press ARB, Edit (F2), Line (F2), Start ADD (F1).



2. Press 1 + 0 + Enter (F5).



3. Press Start Data (F2), 3 + 0, Enter (F5).

Start Data

3

0

Enter

4. Press Stop ADD (F3), 5 + 0, Enter (F5).

Stop ADD

5

0

Enter

5. Press Stop Data (F4), 1 + 0 + 0, Enter (F5), Done (F5).

Stop Data

1

0

0

Enter

Done

ARB – Output Section

Example: ARB Mode, output ARB waveform, start 0, length 1000.

Output

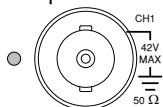

1. Press ARB, Output (F6).

ARB

Output

2. Press Start (F1), 0 + Enter (F5).

Start

0

Enter

3. Press Length (F2), 1 + 0 + 0 + 0, Enter (F5).

Length

1

0

0

0

Enter

ARB – Output N Cycle

Example: ARB Mode, Output N Cycle, Start 0, Length 1000, N Cycle 10.

Output

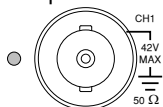

1. Press ARB, Output (F6).

ARB

Output

2. Press Start (F1), 0 + Enter (F5).

Start

0

Enter

3. Press Length (F2), 1 + 0 + 0, Enter (F5).

Length

1

0

0

0
Enter

4. Press N Cycle (F4).

N Cycle

5. Press Cycles (F1), 1 + 0, Enter (F5).

Cycles

1

0

Enter

6. To trigger the output once, press Trigger (F5).

Trigger

ARB – Output Infinite Cycles

Example: ARB Mode, output N cycle, start 0, length 1000, cycles infinite.

Output

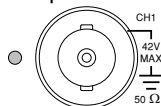

1. Press ARB, Output (F6).

ARB
Output

2. Press Start (F1), 0 + Enter (F5).

Start

0

Enter

3. Press Length (F2), 1 + 0 + 0, Enter (F5).

Length

1

0

0

Enter



4. Press Infinite (F5).

Infinite

Utility Menu



Save

Example: Save to memory file #5.

1. Press UTIL, Memory (F1). 
2. Choose a file using the scroll wheel and press Store (F1), press Done (F5). 



Recall

Example: Recall memory file #5.

1. Press UTIL, Memory (F1). 
2. Choose a file using the scroll wheel and press Recall (F2), press Done (F5). 

Interface GPIB

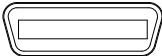



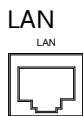

Example: GPIB interface, address 10.

- GPIB 
1. Press UTIL, Interface (F2), GPIB (F1), Address (F1). 
 2. Press 1 + 0 + Done (F5). 

Interface LAN

Example: LAN interface, DHCP IP configuration.





1. Press UTIL, Interface (F2), LAN (F3).   
2. Press Config (F2), DHCP (F1).  
3. Press Done (F3). 

Interface USB

Example: USB interface.







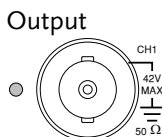

1. Press UTIL, Interface (F2), USB (F2).   

Dual Channel – Frequency Coupling

Example: 1kHz offset coupling. AFG-3022, 3032 only.



1. Press UTIL, Dual Ch (F5), Freq Cpl (F1).   
2. Press Offset (F2), 1 + 0 + kHz (F4).   

Dual Channel – Amplitude Coupling

Example: Amplitude coupling. AFG-3022, 3032 only.

1. Press UTIL, Dual Ch (F5), Ampl Cpl (F2).   

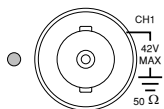

2. Press ON (F1).



Dual Channel – Tracking

Example: Inverted tracking. AFG-3022, 3032 only.

Output

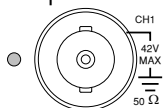

1. Press UTIL, Dual Ch (F5), Tracking (F3).



2. Press Inverted (F3).



Menu Tree

Convention Use the menu trees as a handy reference for the function generator functions and properties. The AFG-3021/3022/3031/3032 menu system is arranged in a hierarchical tree. Each hierarchical level can be navigated with the operation or soft menu keys. Pressing the Return soft key will return you to the previous menu level.

For example: To set the interface to USB;

- (1) Press the UTIL key.
- (2) The Interface soft-key.
- (3) USB.

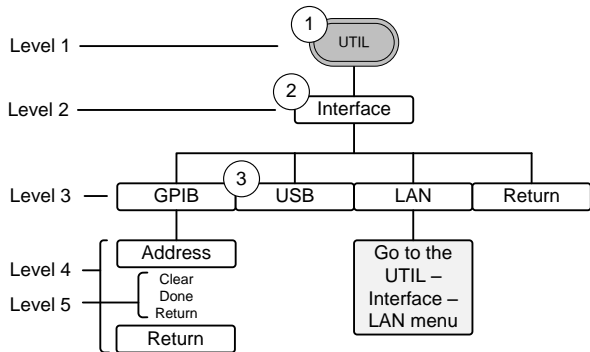

Waveform

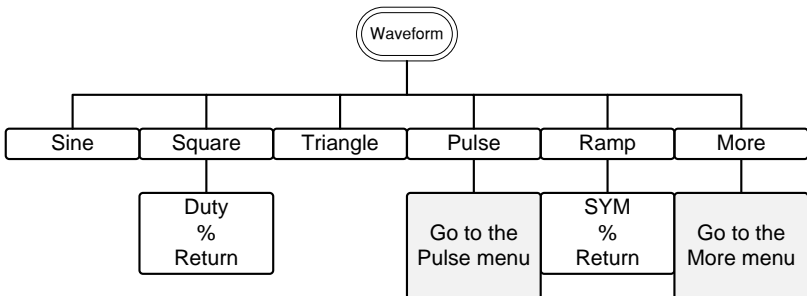

Waveform - Pulse

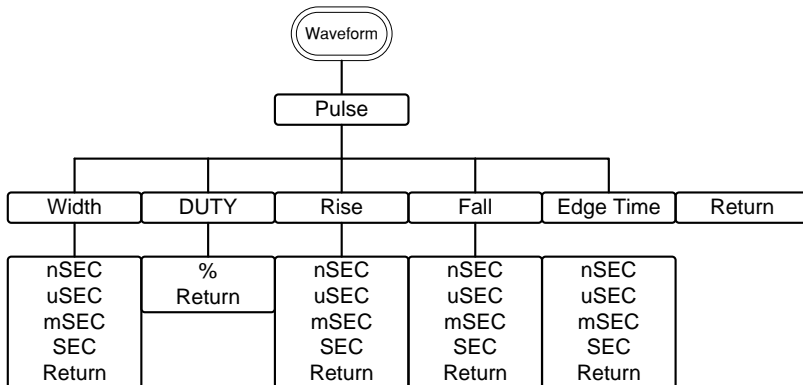

Waveform - More

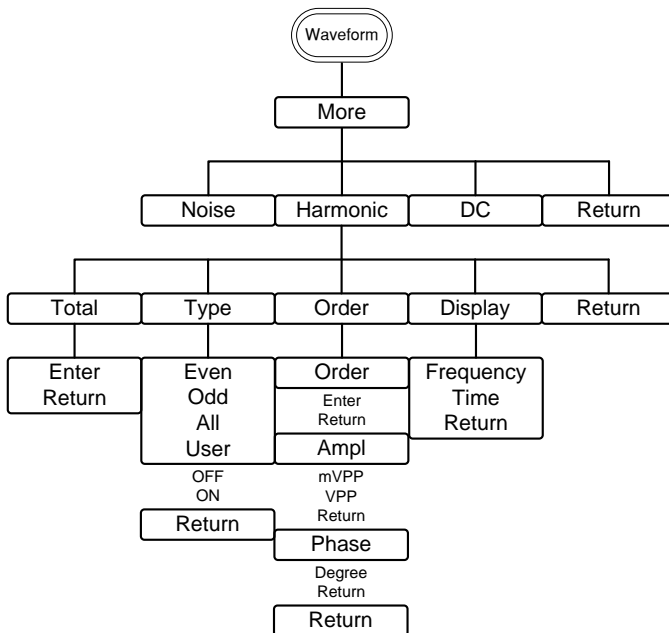

ARB-Display

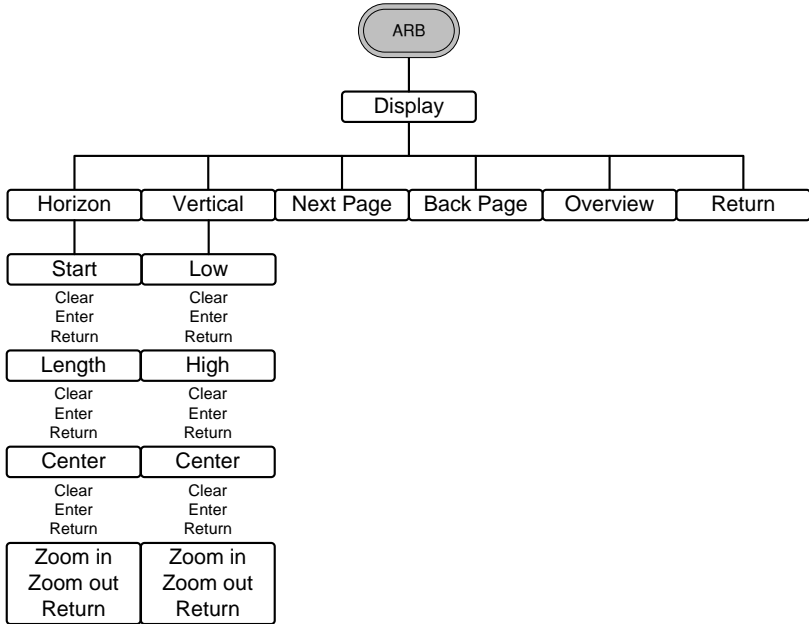

ARB-Edit

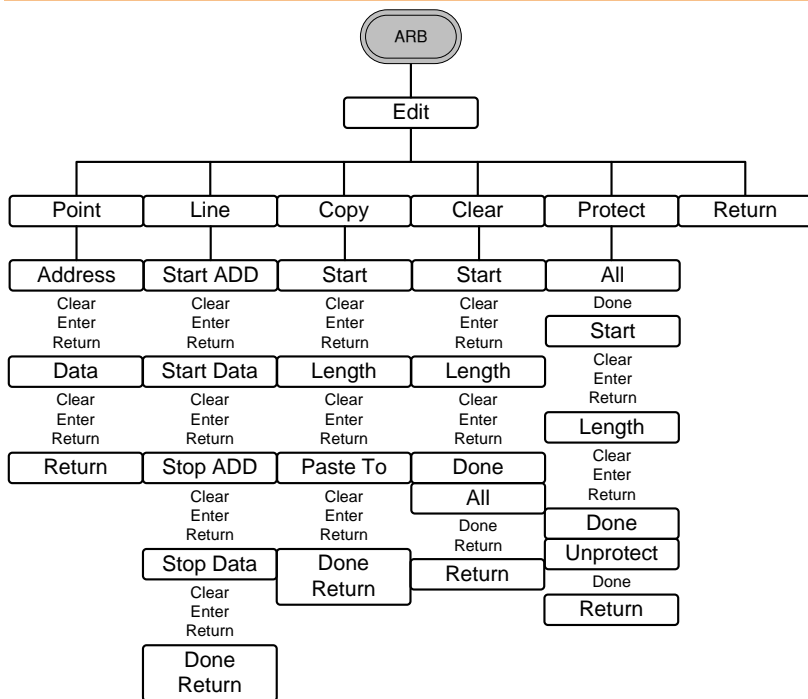

ARB-Built-in

Note: The following menu tree only lists where each built-in ARB waveform is located.

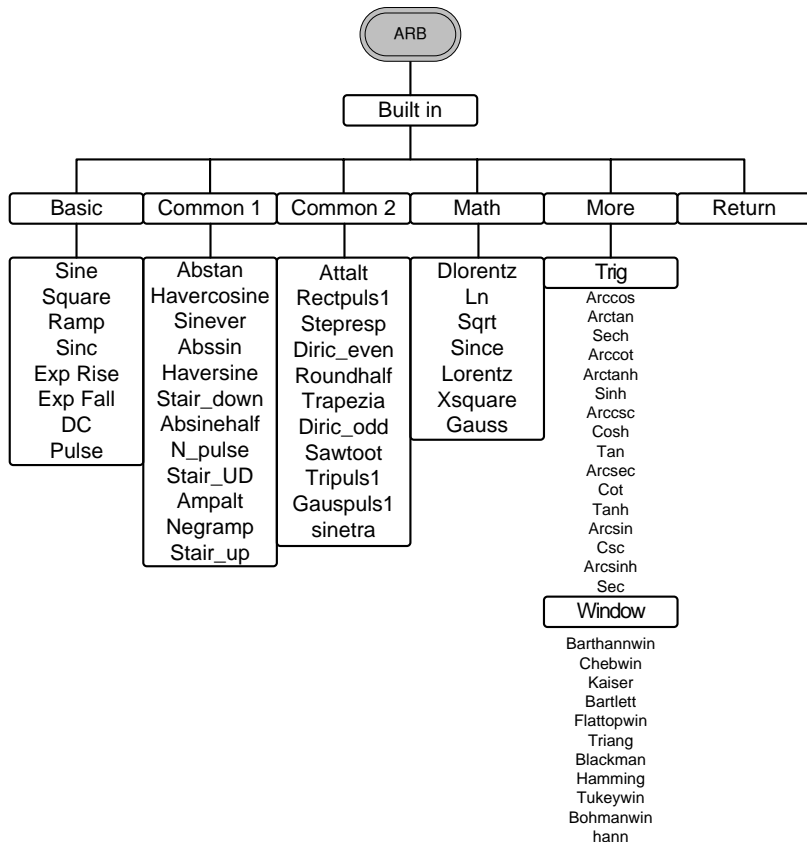

ARB-Built in-Basic

Note: For brevity, only the “Basic” menu tree is listed for the ARB > Built-in menu tree system. The operation menu keys for all the other built-in ARB waveforms are mostly identical to the ones listed below.

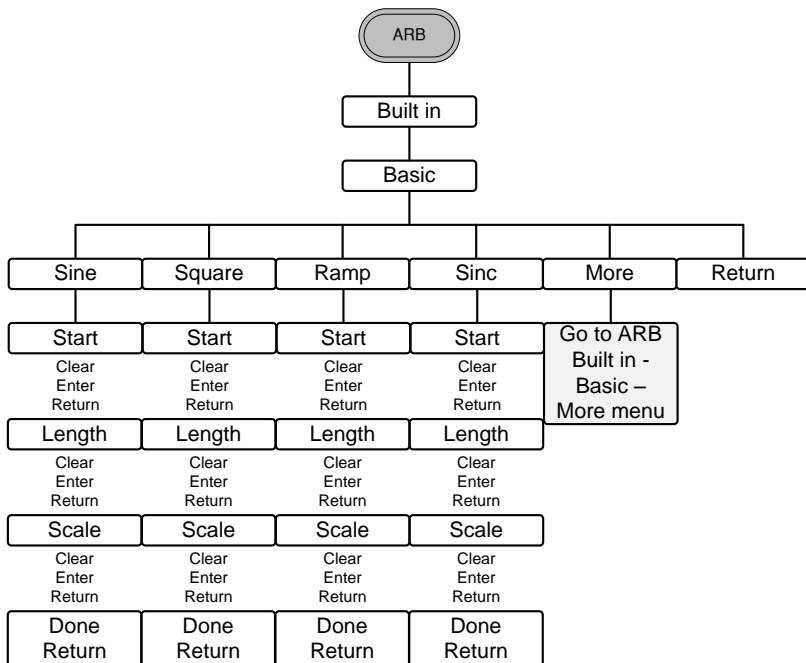

ARB-Save

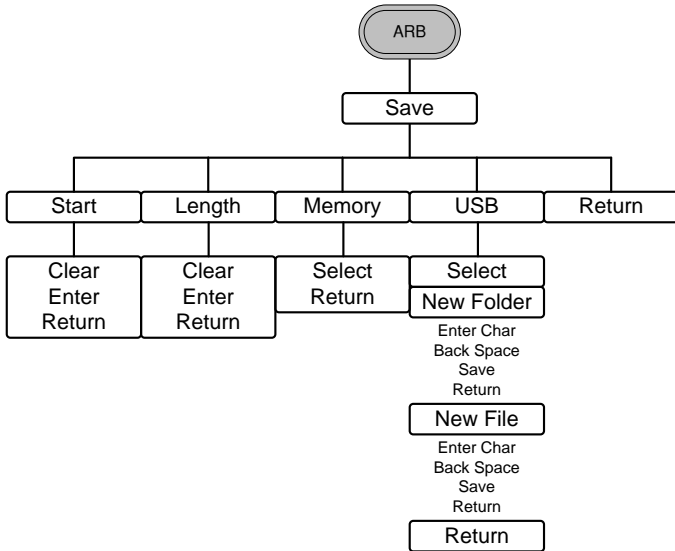

ARB-Load

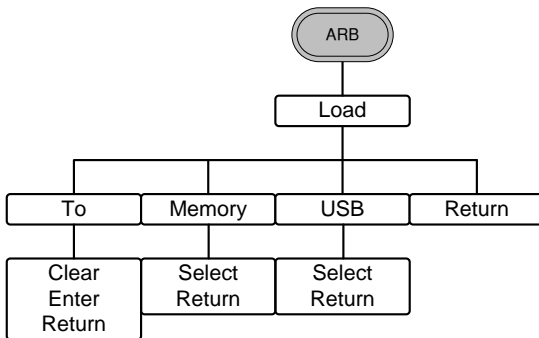

ARB-Output

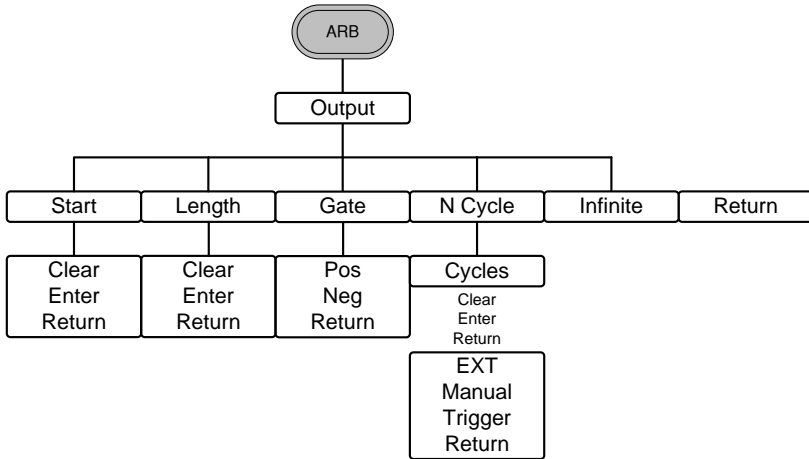

MOD

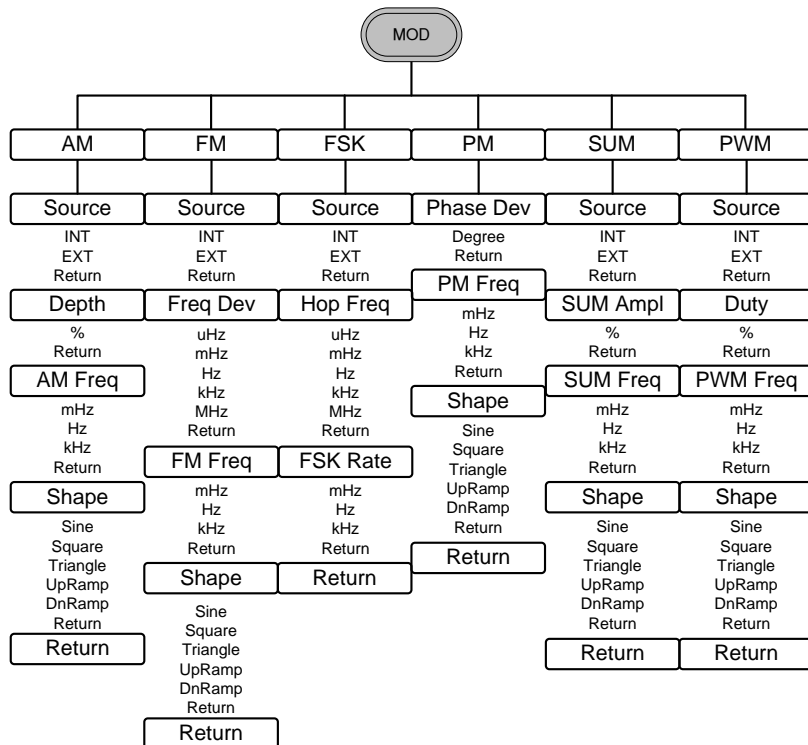

Sweep - Type/MOD = Frequency

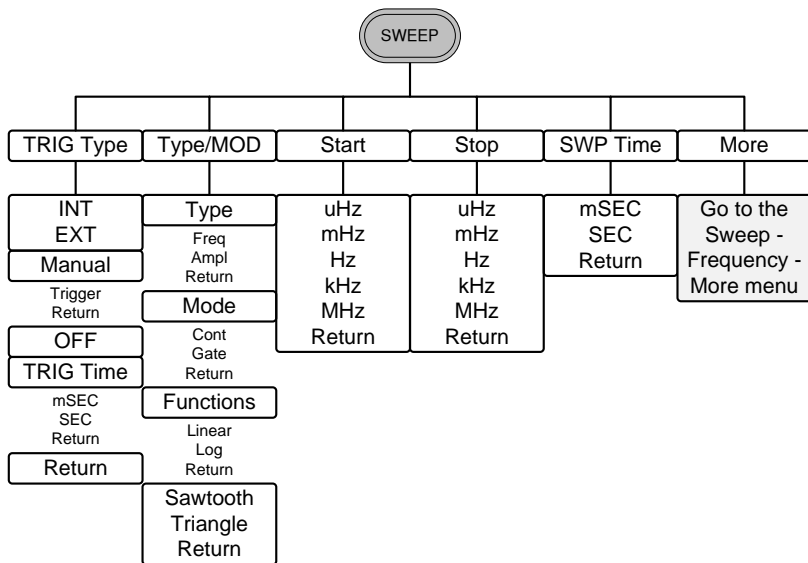

Sweep - More

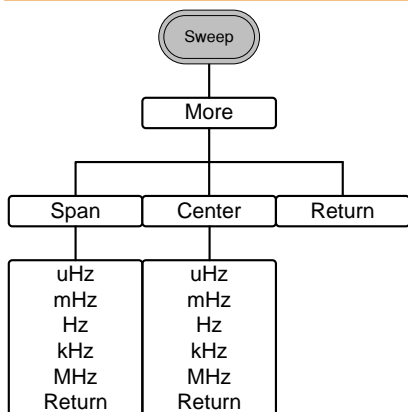

Sweep - Type/MOD = Amplitude

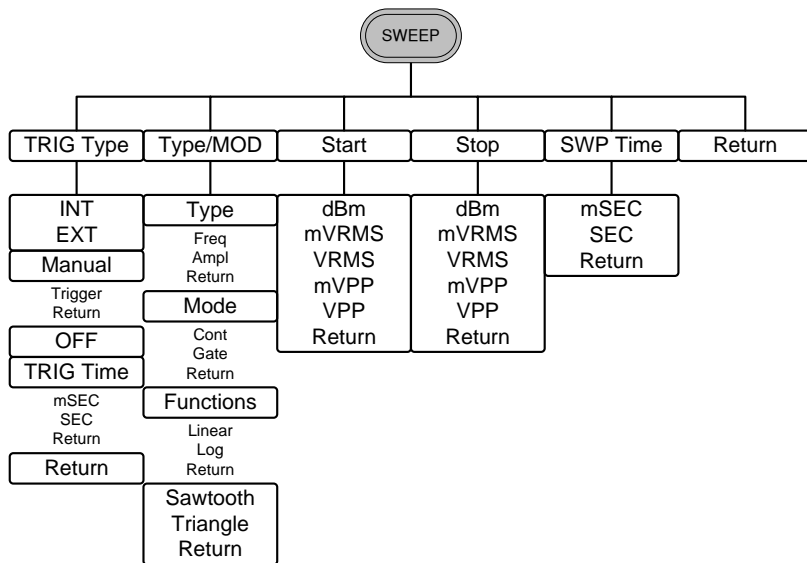

Burst – N Cycle

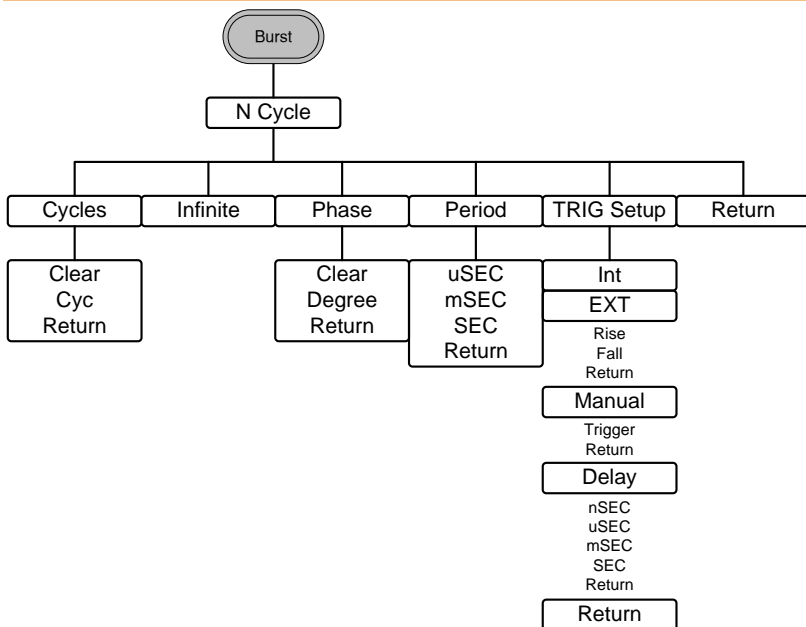

Burst - Gate

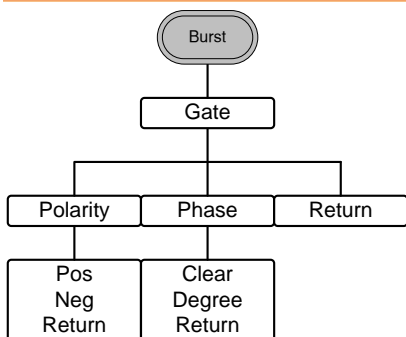

CH1 / CH2 (AFG-3022/AFG-3032 Only)

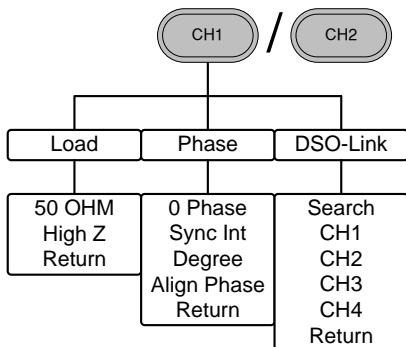

UTIL (AFG-3021/3031)

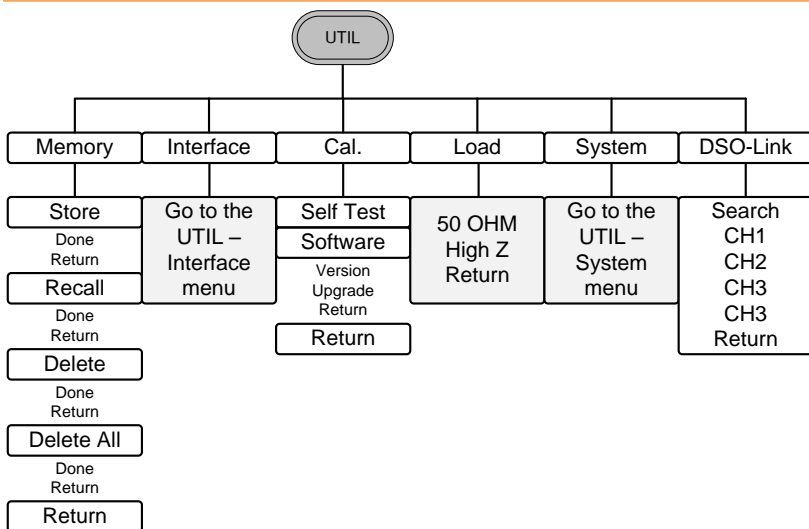

UTIL (AFG-3022/AFG-3032)

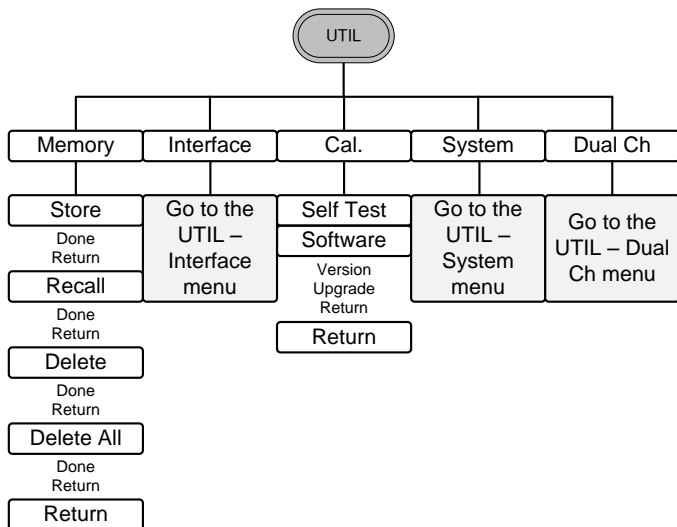

UTIL - Interface

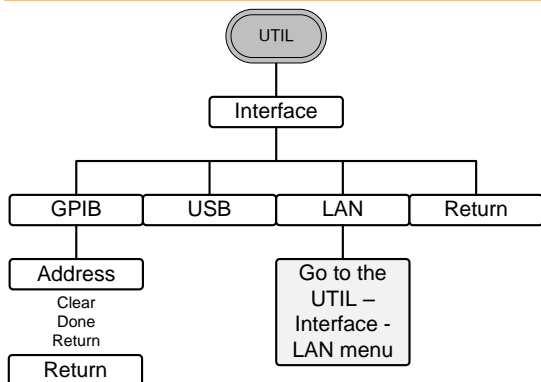

UTIL - Interface - LAN

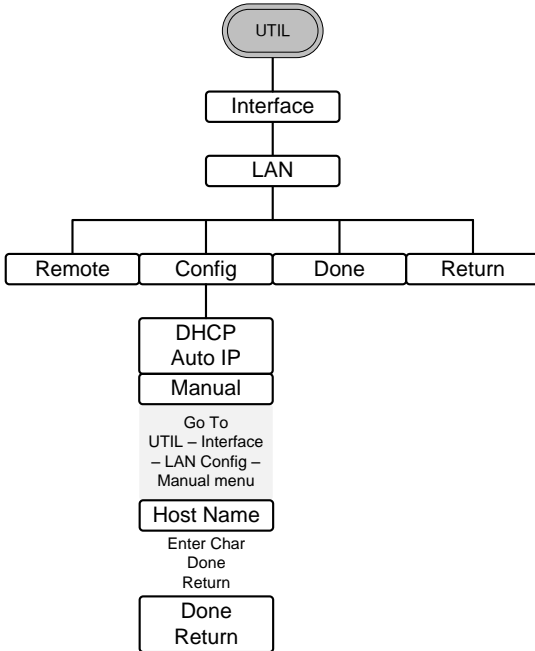

UTIL - Interface - LAN - Config - Manual

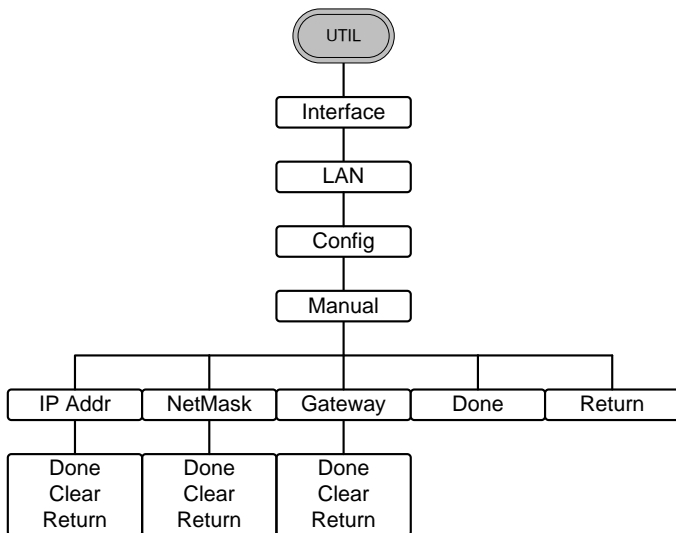

UTIL - System

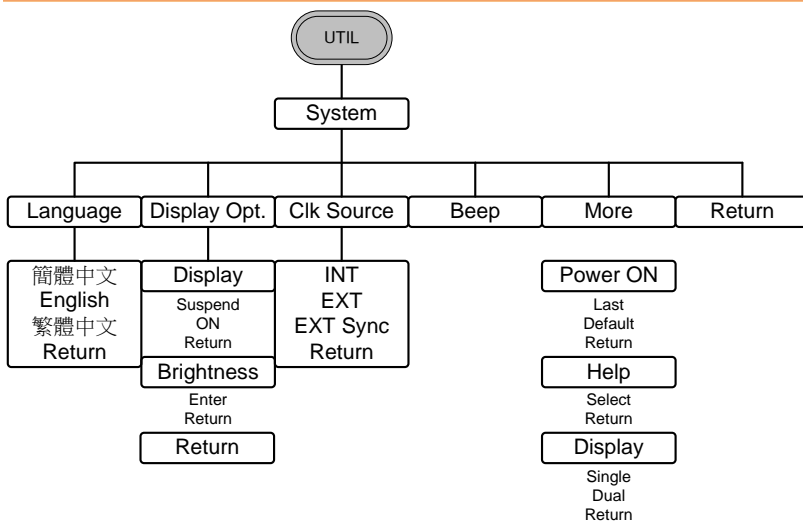

UTIL - Dual Channel

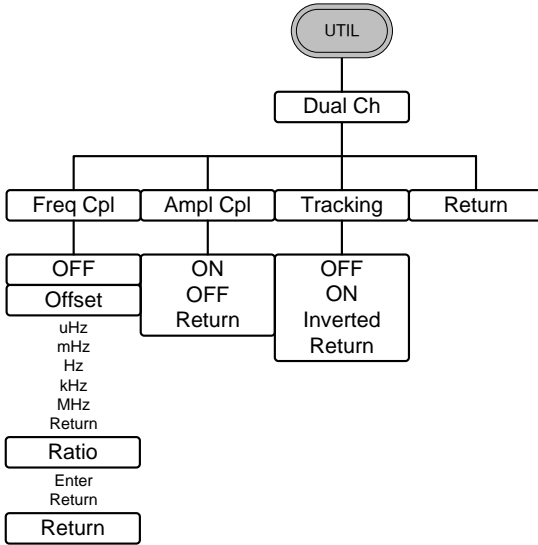

Default Settings

Here are the default panel settings which appear when pressing the Preset key.



Output Config.	Function	Sine wave
	Frequency	1kHz
	Amplitude	3.000 V _{pp}
	Offset	0.00V dc
	Output units	V _{pp}
	Output terminal	50Ω
Modulation (AM/FM/FSK)	Carrier Wave	1kHz Sine wave
	Modulation waveforms	100Hz Sine wave
	AM Depth	100%
	FM Deviation	100Hz
	FSK Hop Frequency	100Hz
	FSK Frequency	10Hz
	PWM Duty	50%
	PWM Frequency	20kHz
	Modem Status	Off
Sweep	Start/Stop frequency	100Hz/1kHz
	Sweep time	1s
	Start/Stop amplitude	1.000/3.000 V _{pp}
	Sweep function	Linear
	Sweep status	Off

Burst	Burst Frequency	1kHz
	Ncycle	1
	Burst period	10ms
	Burst starting phase	0°
	Burst status	Off
Trigger	Trigger source	Internal (immediate)
Interface config.	GPIB Address	10
	Interface	USB
	LAN	DHCP
Calibration	Calibration Menu	Restricted

OPERATION

The Operation chapter shows how to output basic waveform functions. For details on modulation, sweep, burst and arbitrary waveforms, please see the Modulation and Arbitrary waveform chapters on pages 89 and 174. For information on the dual channel and multi-unit operation, please see page 178 & 186, respectively.

Select a Channel	71
CH1/CH2	71
Select a Waveform	72
Sine Wave.....	72
Setting a Square Wave	73
Triangle Wave.....	74
Setting the Pulse Width	75
Setting the Pulse Rise & Fall Time	76
Setting the Pulse Edge Time.....	77
Setting the Pulse Duty Time	78
Setting a Ramp.....	79
Noise Wave	80
Harmonic Wave	80
Harmonic Order	81
Harmonic Characteristics	83
DC Wave.....	84
Setting the Waveform Frequency	85
Setting the Amplitude	87
Setting the DC Offset.....	88

Select a Channel

As the AFG-3022 or AFG-3032 are dual channel models, the desired output channel must first be selected before assigning the operation for that channel.

CH1/CH2

Panel Operation 1. Press the CH1 or CH2 key.



- The selected channel will be visible while the deselected channel will be dimmed.

In the screen shot below, CH1 is selected.

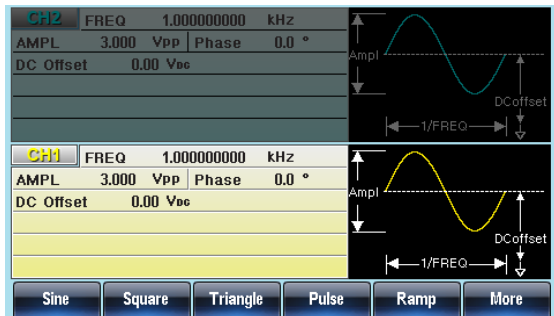

Select a Waveform

The AFG-30XX can output 8 standard waveforms: sine, square, triangle, pulse, ramp, noise, harmonic and DC waveforms.

Sine Wave





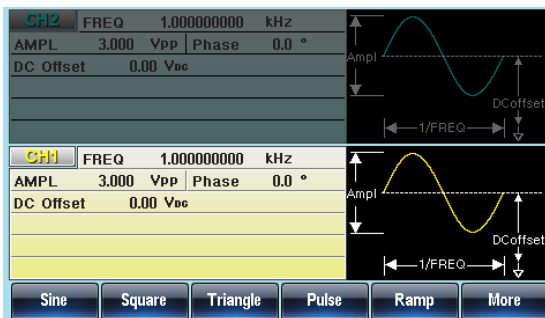

Panel Operation 1. Press the Waveform key.



2. Press F1 (Sine).

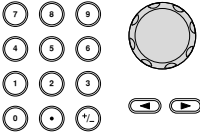

Setting a Square Wave

- Panel Operation
1. Press the Waveform key. 
 2. Press F2 (Square) to create a square waveform.  
 3. Press F1 (Duty). The Duty parameter will be highlighted in the parameter window.  
 4. Use the selector keys and scroll wheel or number pad to enter the Duty range. 
 5. Press F5 (%) to choose % units.  

Range	Frequency	Duty Range
	≤25MHz (20MHz AFG-3021/3022)	20%~80%
	25MHz~≤30MHz	40%~60%

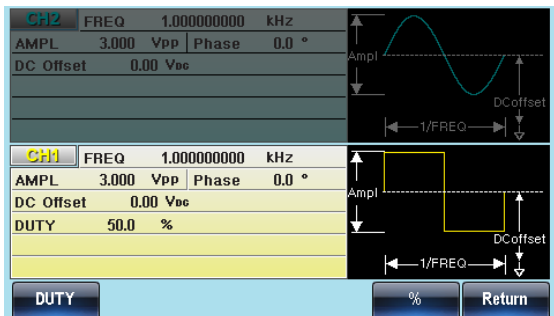

Triangle Wave

Panel Operation 1. Press the Waveform key.

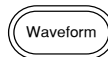

2. Press F3 (Triangle).

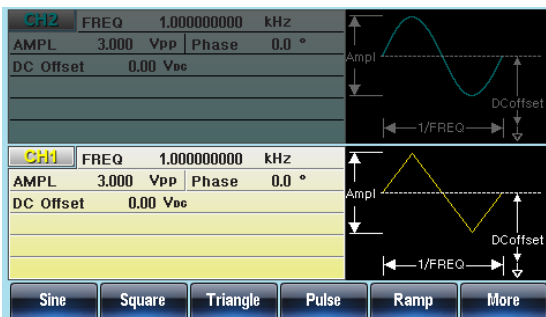

Setting the Pulse Width

The pulse width settings depend on the rise & fall time settings or the edge time setting and the period settings, as defined below:

$$\text{Pulse Width} - 0.625 * [(\text{Rise Time} - 0.6nS) + (\text{Fall Time} - 0.6nS)] \geq 0$$

$$\text{Period} \geq \text{Pulse Width} + 0.625 * [(\text{Rise Time} - 0.6nS) + (\text{Fall Time} - 0.6nS)]$$

Pulse width is defined as the time from the 50% rising edge threshold to the 50% falling edge threshold of one full period.

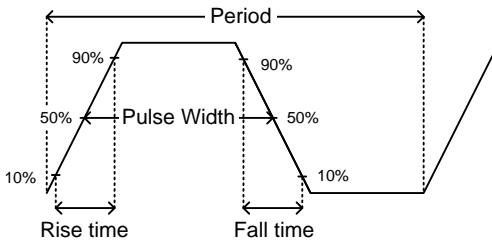

See page 76 to set the rise and fall time settings and page 77 for the edge time settings. Alternatively, instead of setting the pulse width, the pulse duty can be set, see page 78 for details.

Panel Operation 1. Press the Waveform key.

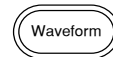

2. Press F4 (Pulse) to create a pulse waveform.



3. Press F1 (Width). The Width parameter will be highlighted in the parameter window.



4. Use the selector keys and scroll wheel or number pad to enter the pulse width.

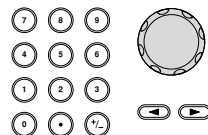

5. Press F2~F5 choose the unit range.



Range Pulse Width 20ns~999.83ks



Note

Resolution: Freq < 25MHz
 (20MHz AFG-3021/3022): 0.01ns pulse width (or 3 digit resolution)
 Freq < 8.5 kHz: 0.0001% duty cycle

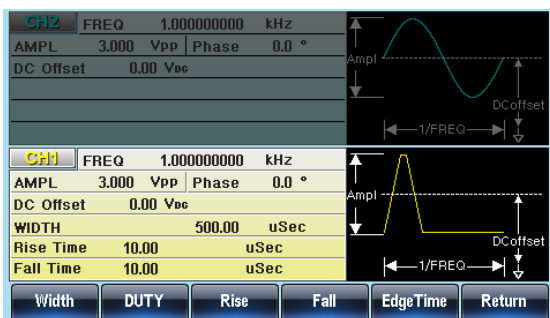

Setting the Pulse Rise & Fall Time

- Panel Operation 1. Press the Waveform key.

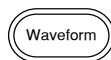

2. Press F4 (Pulse) to create a pulse waveform.



3. Press F3 (Rise) or F4 (Fall). The Rise or Fall parameter will be highlighted in the parameter window.



4. Use the selector keys and scroll wheel or number pad to enter the rise or fall time.

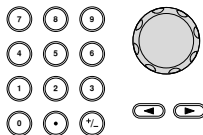

5. Press F2~F5 to choose the unit range.



6. Repeat the above steps for the opposite edge time.

Range	Minimum rise/fall time:	9.32ns ~ 799.9ks
-------	-------------------------	------------------



Note

Duty Considerations: $Width - 0.625 * [(Rise\ Time - 0.6nS) + (Fall\ Time - 0.6nS)] \geq 0$
 $Period \geq Width + 0.625 * [(Rise\ Time - 0.6nS) + (Fall\ Time - 0.6nS)]$

Setting the Pulse Edge Time

The edge time sets the rise and fall time to the same value. The edge time setting can affect the settable pulse width time.

- Panel Operation
1. Press the Waveform key.

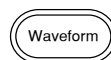

2. Press F4 (Pulse) to create a pulse waveform.



3. Press F5 (Edge Time). The Edge Time parameter will be highlighted in the parameter window.



4. Use the selector keys and scroll wheel or number pad to enter the edge time.

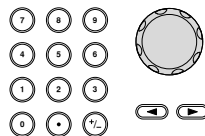

5. Press F2~F5 to choose the unit range.



Range	Edge Time Range	9.32ns~799.9ks
Note	Duty	Width - 1.25 *
	Considerations:	$(\text{Edge Time} - 0.6\text{nS}) \geq 0$
		$\text{Period} \geq \text{Pulse Width} + 1.25 * (\text{Edge time} - 0.6\text{ns})$
		0.0001% duty cycle resolution

Setting the Pulse Duty Time

Instead of setting the pulse width of the pulse, the duty of the pulse can be set. The settable duty times depend on the rise & fall time settings, as defined below:

$$\text{Duty} \geq 0.625 \times 100 \times [\text{rise time} - 0.6\text{ns} + \text{fall time} - 0.6\text{ns}] / \text{period}$$

Or

$$\text{Duty} \leq 100 - \{62.5 \times [(\text{rise time} - 0.6\text{ns}) + (\text{fall time} - 0.6\text{ns})] / \text{period}\}$$

- Panel Operation 1. Press the Waveform key.

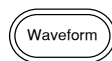

2. Press F4 (Pulse) to create a pulse waveform.



3. Press F2 (DUTY). The DUTY parameter will be highlighted in the parameter window.



4. Use the selector keys and scroll wheel or number pad to enter the duty time.

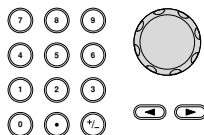







5. Press F1 to choose the % unit.

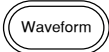

Range	Duty Range	0.0170%~99.983% Resolution 0.0001%
-------	------------	---------------------------------------

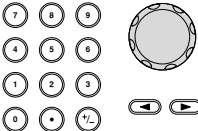
Setting a Ramp

- Panel Operation
1. Press the Waveform key. 
 2. Press F5 (Ramp) to create a ramp waveform.  
 3. Press F1 (SYM). The SYM parameter will be highlighted in the parameter window.  
 4. Use the selector keys and scroll wheel or number pad to enter the symmetry percentage. 
 5. Press F5 (%) to choose % units.  

Range	Symmetry	0%~100%
-------	----------	---------



Noise Wave

Panel Operation 1. Press the Waveform key.

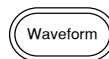

2. Press F6 (More).



3. Press F1 (Noise).

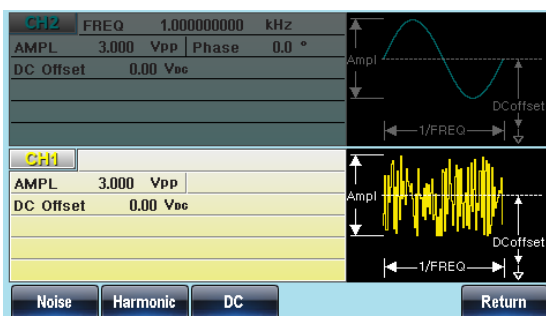

Harmonic Wave

The harmonic wave function creates a harmonic sine wave with a designated number of harmonics.

Panel Operation 1. Press the Waveform key.

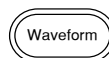

2. Press F6 (More).



3. Press F2 (Harmonic).



4. Press F1 (Total) to choose the total number of harmonics. This includes the fundamental harmonic.



5. Use the selector keys and scroll wheel or number pad to enter the number of harmonics.

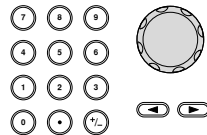

Range Number of harmonics 2 ~ 8

6. Press F1 (Enter).

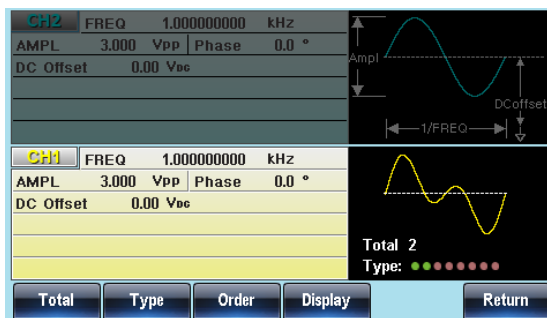

Harmonic Order

After the total number of harmonics has been selected(above), you can also select which harmonic orders are used: odd, even, all or a user-defined set.

- Panel Operation 1. Press the Waveform key.

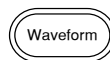

2. Press F6 (More).



3. Press F2 (Harmonic).



4. Press F2 (Type).



5. Press F1 ~ F4 to chose which harmonic orders to include in the resultant harmonic waveform.
- Even

F1

~

User

F4

Note: You may have to wait a short while for the meter to process the waveform.

Range	Harmonic	Even, Odd, ALL, User
-------	----------	----------------------

Selecting User-Defined Orders

1. If User was chosen, each order can be individually selected or deselected.
2. Turn the User defined orders on or off:

Turn the scroll wheel to move the cursor to the desired order in the "Type" parameter on the waveform display screen.



- Selected orders are shown as green dots.
- Deselected orders are shown as grey dots.
- The cursor is shown as a yellow dot.
- Orders are shown from 1st (left side) to 8th (right side).

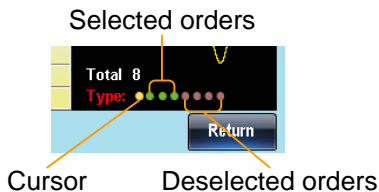

3. Turn the selected order on or off using the F1 or F2 soft-keys.
- OFF

F1

ON

F2

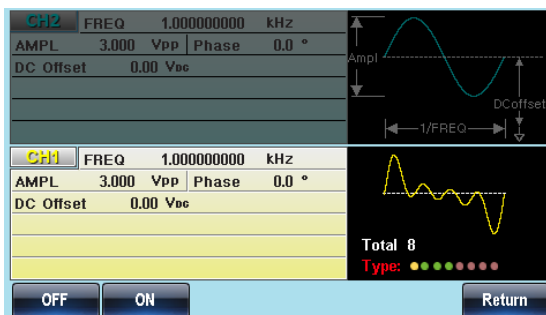

Harmonic Characteristics

The amplitude and phase of each harmonic order can individually set. By default the amplitude is the same as the fundamental frequency and the phase is set to 0°.

Panel Operation 1. Press the Waveform key.

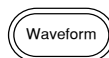

2. Press F6 (More).



3. Press F2 (Harmonic).



4. Press F3 (Order).



5. Press F1 (Order).



6. The Order parameter will become highlighted in red.

7. Use the selector keys and scroll wheel or number pad to select an order.

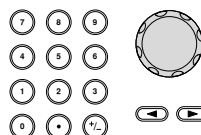



8. Press F5 (Enter).



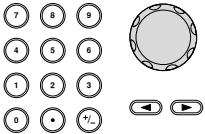

- 9. Press F2 (Amplitude). 

- 10. Use the selector keys and scroll wheel or number pad to set the amplitude of previously selected order. 

- 11. Choose the amplitude unit by pressing F4~F5. 

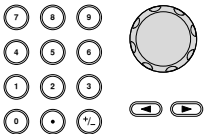
- 12. Press F3 (Phase). 

- 13. Use the selector keys and scroll wheel or number pad to set the phase of the previously selected order. 

- 14. Press F5 (Degree). 

DC Wave

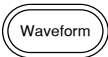
- Panel Operation
- 1. Press the Waveform key. 

 - 2. Press F6 (More). 

 - 3. Press F3 (DC). 

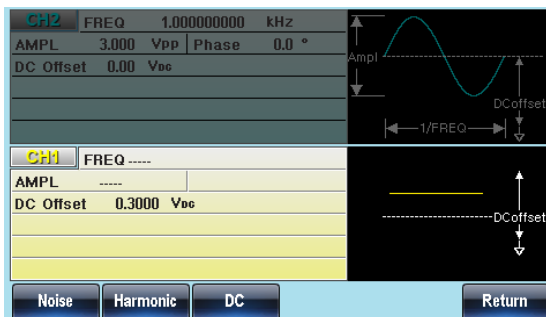

Setting the Waveform Frequency

Panel Operation 1. Press the **FREQ/Rate** key.



2. The **FREQ** parameter will become highlighted in the parameter window.

3. Use the selector keys and scroll wheel or number pad to enter the frequency.

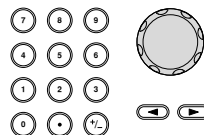

4. Choose a frequency unit by pressing **F2~F6**.



Range	Sine	1μHz~30MHz (20MHz AFG-3021/3022)
	Square	1μHz~30MHz (20MHz AFG-3021/3022)
	Triangle	1μHz~1MHz
	Pulse	1μHz~25MHz (20MHz AFG-3021/3022)
	Ramp	1μHz~1MHz

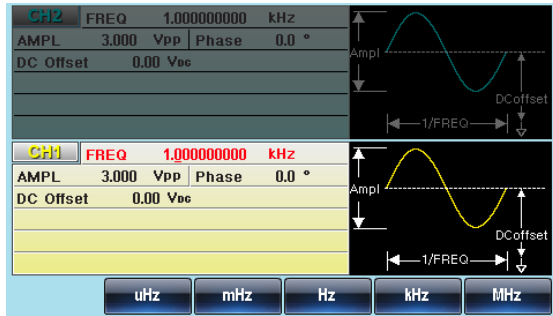

Setting the Amplitude

Panel Operation 1. Press the AMPL key.



2. The AMPL parameter will become highlighted in the parameter window.

3. Use the selector keys and scroll wheel or number pad to enter the amplitude.

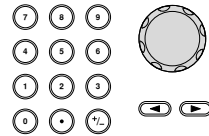

4. Choose a unit type by pressing F2~F6.



Range	50Ω load	High Z
	1mVpp~10Vpp	2mVpp~20Vpp
Unit	Vpp, Vrms, dBm	

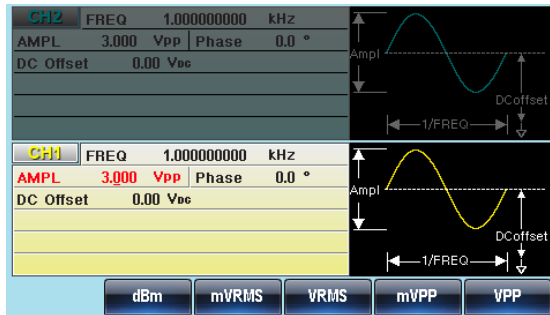

Setting the DC Offset

Panel Operation 1. Press the DC Offset key.

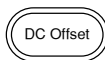

2. The DC Offset parameter will become highlighted in the parameter window.

3. Use the selector keys and scroll wheel or number pad to enter the DC Offset.

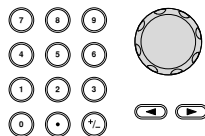

4. Press F5 (mVDC) or F6 (VDC) to choose a voltage range.



	50Ω load	High Z
Range	±5Vdc	±10Vdc

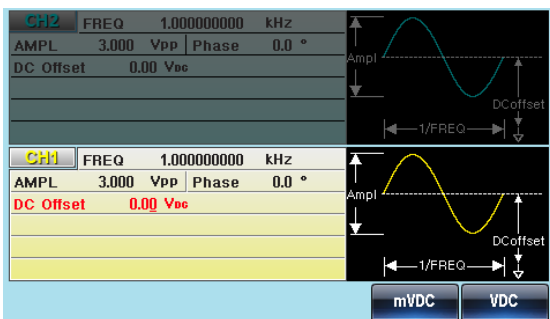

MODULATION

The AFG-3021, AFG-3022, AFG-3031 & AFG-3032 Arbitrary Function Generators are able to produce AM, FM, FSK and PWM modulated waveforms as well as swept waveforms (frequency, amplitude) and burst waveforms. Depending on the type of waveform produced, different modulation parameters can be set. Two different modulation modes can be active at the same time for the AFG-3022 & AFG-3032.

Amplitude Modulation (AM)	91
Selecting AM Modulation	92
AM Carrier Shape	92
Carrier Frequency	93
Modulating Wave Shape	94
AM Frequency	95
Modulation Depth	96
Selecting (AM) Modulation Source	98
Frequency Modulation (FM)	100
Selecting Frequency Modulation (FM)	101
FM Carrier Shape	101
FM Carrier Frequency	102
FM Wave Shape	103
Modulation Frequency	104
Frequency Deviation	105
Selecting (FM) Modulation Source	106
Frequency Shift Keying (FSK) Modulation	108
Selecting FSK Modulation	109
FSK Carrier Shape	109
FSK Carrier Frequency	110
FSK Hop Frequency	111
FSK Rate	112
FSK Source	113
Phase Modulation (PM)	115
Selecting Phase Modulation (PM)	116
PM Carrier Shape	116
PM Carrier Frequency	117

PM Wave Shape	118
Modulation Frequency.....	119
Phase Modulation Deviation	120
SUM Modulation	121
Selecting SUM Modulation	122
SUM Carrier Shape	122
SUM Carrier Frequency.....	123
SUM Modulating Wave Shape	123
SUM Frequency.....	124
SUM Amplitude	125
SUM Source	126
Pulse Width Modulation	128
Selecting Pulse Width Modulation	129
PWM Carrier Shape.....	129
PWM Carrier Frequency.....	130
PWM Modulating Wave Shape.....	130
Modulating Waveform Frequency	131
Modulation Duty Cycle	132
PWM Source	133
Sweep	135
Selecting Sweep Mode.....	136
Sweep Type	136
Setting Start and Stop Frequency/Amplitude	137
Center Frequency and Span.....	138
Sweep Mode.....	140
Sweep Function.....	140
Sweep Waveform Type.....	141
Sweep Time.....	142
Sweep Trigger Source	144
Burst Mode	146
Selecting Burst Mode.....	146
Burst Modes.....	146
Burst Frequency	147
Burst Cycle/Burst Count	148
Infinite Burst Count	150
Burst Period	150
Burst Phase	152
Burst Trigger Source	153
Burst Delay.....	155
Gated Trigger Polarity.....	156
Gated Trigger Phase	156

Amplitude Modulation (AM)

An AM waveform is produced from a carrier waveform and a modulating waveform. The amplitude of the modulated carrier waveform depends on the amplitude of the modulating waveform. The AFG-30XX function generator can set the carrier frequency, amplitude and offset as well as internal or external modulation sources. When using the function generator, only one type of modulated waveform can be created at any one time for the selected channel.

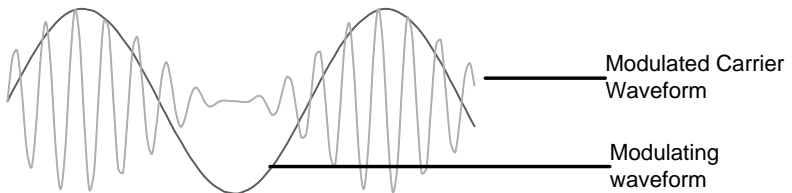

Selecting AM Modulation

Panel Operation 1. Press the MOD key.



2. Press F1 (AM).

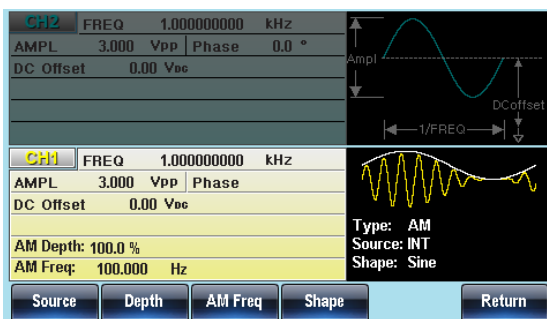

AM Carrier Shape

Background

Sine, square, triangle, ramp, pulse, noise or arbitrary waveforms can be used as the carrier shape. The default waveform shape is set to sine. Harmonic and DC are not available as a carrier shape. Before the carrier shape can be selected, choose AM modulation mode, see page 36 or 94.

Select a Standard Carrier Shape 1. Press the Waveform key.

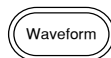

2. Press F1~F5 to choose the carrier wave shape.





Select an Arbitrary Waveform Carrier Shape.	3. See the Arbitrary waveform quick guide or chapter to use an arbitrary waveform.	Page 44 Page 174
---------------------------------------------	------------------------------------------------------------------------------------	---------------------

Range	AM Carrier Shape	sine, square, triangle, pulse, ramp, arbitrary waveform
-------	------------------	---------------------------------------------------------

Carrier Frequency

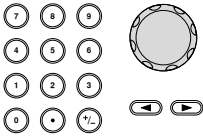
The maximum carrier frequency depends on the carrier shape selected. The default carrier frequency for all carrier shapes is 1kHz.

- Panel Operation
- With a carrier waveform, press the **FREQ/Rate** key. 
 - The **FREQ** parameter will become highlighted in the parameter window.
 - Use the selector keys and scroll wheel or number pad to enter the carrier frequency. 
 - Press **F2~F6** to select the frequency range. 









Range	Carrier Shape	Carrier Frequency
	Sine	1μHz~30MHz (20MHz AFG-3021/3022)
	Square	1μHz~30MHz (20MHz AFG-3021/3022)
	Triangle	1μHz~1MHz
	Pulse	1μHz~25MHz (20MHz AFG-3021/3022)
	Ramp	1μHz~1MHz

Continued next page

Noise	N/A
ARB	125MHz to 1μHz

Modulating Wave Shape

The function generator can accept internal as well as external sources. The AFG-30XX has sine, square, triangle, up ramp and down ramp modulating waveform shapes. Sine waves are the default wave shape.

- Panel Operation
1. Select MOD. 
 2. Press F1 (AM).  
 3. Press F4 (Shape).  
 4. Press F1~F5 to select the waveform shape.    

Note	Square wave	50% Duty cycle
	UpRamp	100% Symmetry
	Triangle	50% Symmetry
	DnRamp	0% Symmetry

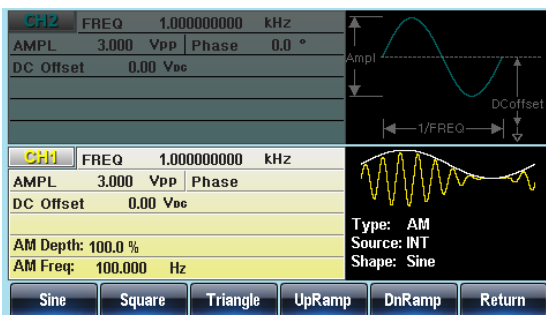

AM Frequency

The frequency of the modulation waveform (AM Frequency) can be set from 2mHz to 20kHz.

Panel Operation 1. Press the MOD key.



2. Press F1 (AM).



3. Press F3 (AM Freq).



4. The AM Freq parameter will become highlighted in the Waveform display area.

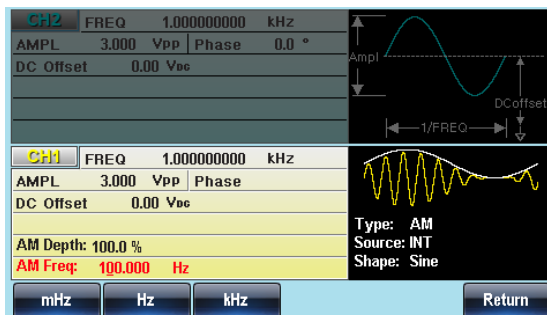

5. Use the selector keys and scroll wheel or number pad to enter the AM frequency.

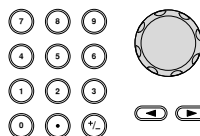

6. Press F1~F3 to select the frequency range.



Range	Modulation frequency	2mHz~20kHz
	Default frequency	100Hz

Modulation Depth

The modulation depth determines the maximum and minimum amplitude of the AM waveform. The modulation depth (as a percentage) is defined by the ratio of the modulating waveform voltage and the carrier waveform voltage multiplied by 100:

$$\text{ModulationDepth} = \frac{\text{ModulatingWaveVoltage}}{\text{CarrierWaveVoltage}} \times 100$$

The maximum and minimum peak to peak voltage of the modulated waveform can then be defined by:

$$V_{\text{max}} = V_{\text{pp}} = V_c \times \left(1 + \frac{\text{Depth}}{100}\right)$$

$$V_{\text{min}} = V_c \times \left(1 - \frac{\text{Depth}}{100}\right)$$

Below is a visual explanation of the relationship between the modulation signal, carrier signal and the resulting output signal.

Note: V_{pp} is the amplitude setting on the AFG.

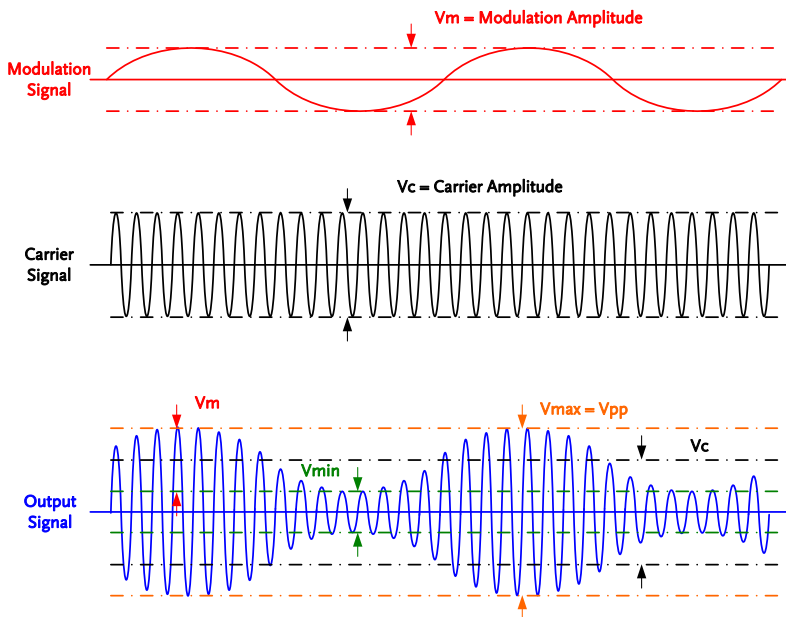

Panel Operation 1. Press the MOD key.



2. Press F1 (AM).



3. Press F2 (Depth).



4. The AM Depth parameter will become highlighted in the waveform display area.

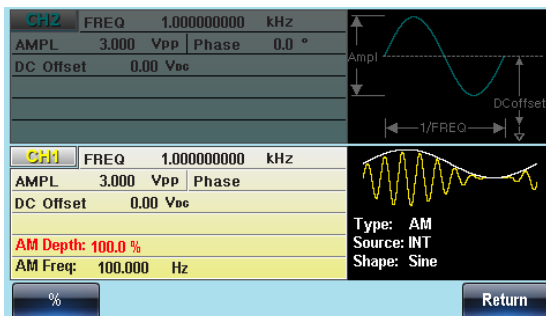

5. Use the selector keys and scroll wheel or number pad to enter the AM depth.

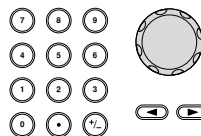

6. Press F1 (%) to choose % units.



Range	Depth	0%--120%
	Default depth	100%

Note When the modulation depth is greater than 100%, the output cannot exceed $\pm 5V_{Peak}$ (10k Ω load).

If an external modulation source is selected, modulation depth is limited to $\pm 5V$ from the MOD INPUT terminal on the rear panel. For example, if modulation depth is set to 100%, then the maximum amplitude is +5V, and the minimum amplitude is -5V.

Selecting (AM) Modulation Source

The function generator will accept an internal or external source for AM modulation. The default source is internal.

Panel Operation 1. Press the MOD key.



2. Press F1 (AM).



3. Press F1 (Source).



4. To select the source, press F1 (Internal) or F2 (External).



External Source Use the MOD INPUT terminal on the rear panel when using an external source.

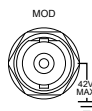

For AFG-3022/3032, using the CH1 or CH2 MOD input depends on which channel is used for modulation.

Note If an external modulation source is selected, modulation depth is limited to $\pm 5V$ from the MOD INPUT terminal on the rear panel. For example, if modulation depth is set to 100%, then the maximum amplitude is +5V, and the minimum amplitude is -5V.

CH2	FREQ	1.000000000	kHz
AMPL	3.000	Vpp	Phase 0.0 °
DC Offset	0.00	Vdc	
CH1	FREQ	1.000000000	kHz
AMPL	3.000	Vpp	Phase
DC Offset	0.00	Vdc	
AM Depth:		100.0 %	
AM Freq:		100.000 Hz	
		Type: AM	
		Source: INT	
		Shape: Sine	
INT		EXT	
			Return

Frequency Modulation (FM)

An FM waveform is produced from a carrier waveform and a modulating waveform. The instantaneous frequency of the carrier waveform varies with the magnitude of the modulating waveform. When using the function generator, only one type of modulated waveform can be created at any one time for the selected channel.

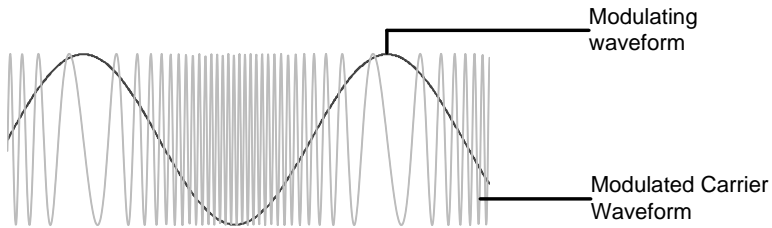

Selecting Frequency Modulation (FM)

When FM is selected, the modulated waveform depends on the carrier frequency, the output amplitude and offset voltage.

Panel Operation 1. Press the MOD key.



2. Press F2 (FM).

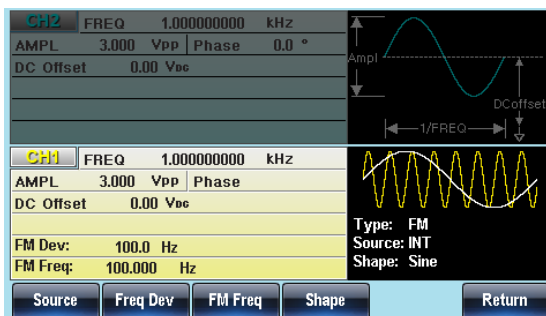

FM Carrier Shape

Background The default carrier waveform shape is set to sine. Sine, square, triangle or ramp waveforms can be used as the carrier shape. Noise, Pulse, ARB, DC and Harmonic waveforms cannot be used as a carrier wave.

Panel Operation 1. Press the Waveform key.

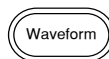



2. Press F1~F5 to choose the carrier wave shape. (bar F4)



Range Carrier Shape Sine, Square, Triangle, Ramp.

FM Carrier Frequency

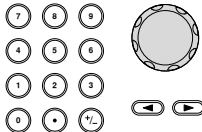
When using the AFG-30XX function generator, the carrier frequency must be equal to or greater than the frequency deviation. If the frequency deviation is set to a value greater than the carrier frequency, the deviation is set to the maximum allowed. The maximum frequency of the carrier wave depends on the waveform shape chosen.

- Panel Operation
- To select the carrier frequency, press the **FREQ/Rate** key. 
 - The **FREQ** parameter will become highlighted in the parameter window.
 - Use the selector keys and scroll wheel or number pad to enter the carrier frequency. 
 - Press **F2~F6** to select the frequency unit. 

Range	Carrier Shape	Carrier Frequency
	Sine	1 μ Hz~30MHz (20MHz AFG-3021/3022)
	Square	1 μ Hz~30MHz (20MHz AFG-3021/3022)
	Triangle	1 μ Hz~1MHz
	Ramp	1 μ Hz~1MHz
	Default frequency	1 kHz

FM Wave Shape

The function generator can accept internal as well as external sources. The AFG-30XX has sine, square, triangle, positive and negative ramps (UpRamp, DnRamp) as the internal modulating waveform shapes. Sine is the default wave shape.

Panel Operation 1. Select MOD.



2. Press F2 (FM).



3. Press F4 (Shape).



4. Press F1~F5 to select the waveform shape.



Note

Square wave	50% Duty cycle
UpRamp	100% Symmetry
Triangle	50% Symmetry
DnRamp	0% Symmetry

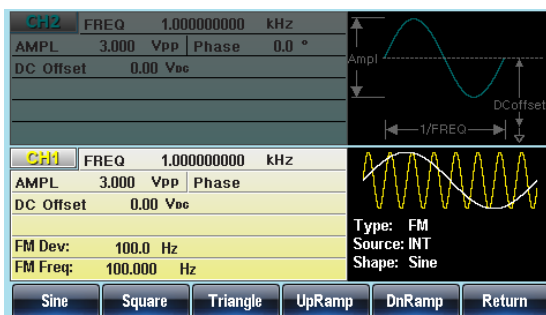

Modulation Frequency

For frequency modulation, the function generator will accept internal or external sources.

Panel Operation 1. Press the MOD key.



2. Press F2 (FM).



3. Press F3 (FM Freq).



4. The FM Freq parameter will become highlighted in the waveform display panel.

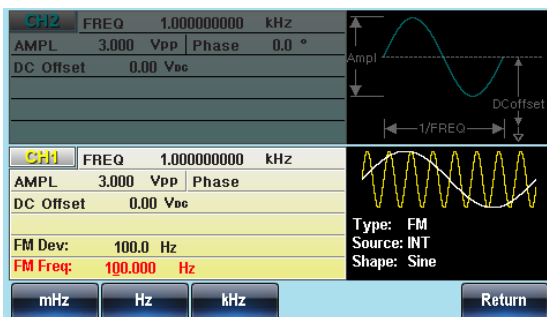

5. Use the selector keys and scroll wheel or number pad to enter the FM frequency.

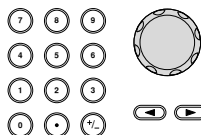

6. Press F1~F3 to select the frequency unit.



Range	Modulation frequency	2mHz~20kHz
	Default frequency	100Hz

Frequency Deviation

The frequency deviation is the peak frequency deviation from the carrier wave and the modulated wave.

Panel Operation 1. Press the MOD key.



2. Press F2 (FM).



3. Press F2 (Freq Dev).



4. The Freq Dev parameter will become highlighted in the waveform display panel.

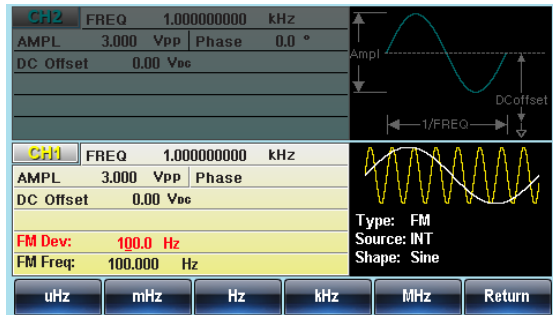

5. Use the selector keys and scroll wheel or number pad to enter the frequency deviation.

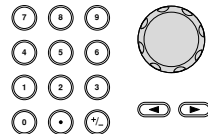





6. Press F1~ F5 to choose the frequency units.



Range	Frequency	DC~30MHz (20MHz AFG-3021/3022)
	Deviation	DC~1MHz(Triangle)
	Default deviation	100kHz

Selecting (FM) Modulation Source

The function generator will accept an internal or external source for FM modulation. The default source is internal.

- Panel Operation
1. Press the MOD key. 
 2. Press F2 (FM). 
 3. Press F1 (Source). 
 4. To select the source, press F1 (Internal) or F2 (External). 

External Source Use the MOD INPUT terminal on the rear panel when using an external source. 

For AFG-3022/3032, using the CH1 or CH2 MOD input depends on which channel is used for modulation.

Note If an external modulating source is selected, the frequency deviation is limited to the $\pm 5V$ MOD INPUT terminal on the rear panel. The frequency deviation is proportional to the signal level of the modulation in voltage. For example, if the modulation in voltage is +5V, then the frequency deviation would be equal to the set frequency deviation. Lower signal levels reduce the frequency deviation while negative voltage levels produce frequency deviations with frequencies

below the carrier waveform.

CH2	FREQ	1.000000000	kHz	
AMPL	3.000	Vpp	Phase 0.0 °	
DC Offset	0.00	Vdc		
CH1	FREQ	1.000000000	kHz	
AMPL	3.000	Vpp	Phase	
DC Offset	0.00	Vdc		
				Type: FM Source: INT Shape: Sine
FM Dev: 100.0 Hz				
FM Freq: 100.000 Hz				
INT		EXT		Return

Frequency Shift Keying (FSK) Modulation

Frequency Shift Keying Modulation is used to shift the frequency output of the function generator between two preset frequencies (carrier frequency, hop frequency). The frequency at which the carrier and hop frequency shift is determined by the internal rate generator or the voltage level from the Trigger INPUT terminal on the rear panel.

Only one modulation mode can be used at once for the selected channel. When FSK modulation is enabled, any other modulation modes will be disabled. Sweep and Burst also cannot be used with FSK modulation. Enabling FSK will disable Sweep or Burst mode.

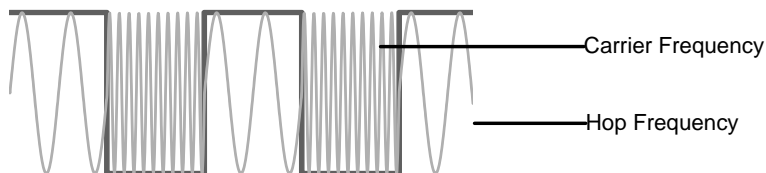

Selecting FSK Modulation

When using FSK mode, the output waveform uses the default settings for carrier frequency, amplitude and offset voltage.

Panel Operation 1. Press the MOD key.



2. Press F3 (FSK).

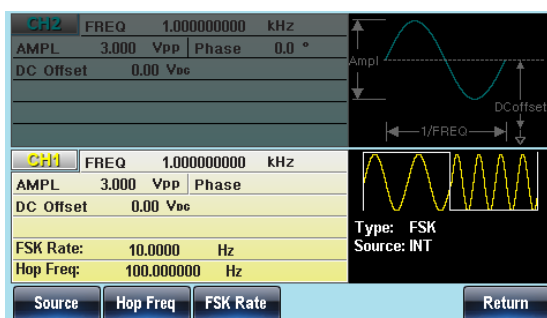

FSK Carrier Shape

Background Sine, square, triangle and ramp waveforms can be used as a carrier shape. The default carrier waveform shape is set to sine. Pulse, noise, harmonic, DC and ARB waveforms cannot be used as carrier waves.

Panel Operation 1. Press the Waveform key.

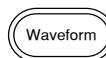

2. Press F1~F5 to choose the carrier wave shape.





Range

Carrier Shape

Sine, Square, Triangle, Ramp.

FSK Carrier Frequency

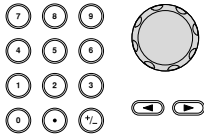
The maximum carrier frequency depends on the carrier shape. The default carrier frequency for all carrier shapes is 1kHz. The voltage level of the Trigger INPUT signal controls the output frequency when EXT is selected. When the Trigger INPUT signal is logically low the carrier frequency is output and when the signal is logically high, the hop frequency is output.

- Panel Operation
- To select the carrier frequency, press the **FREQ/Rate** key. 
 - The **FREQ** parameter will become highlighted in the parameter window.
 - Use the selector keys and scroll wheel or number pad to enter the carrier frequency. 
 - Press **F2~F6** to select the FSK frequency units. 

Range	Carrier Shape	Carrier Frequency
	Sine	1μHz~30MHz (20MHz AFG-3021/3022)
	Square	1μHz~30MHz (20MHz AFG-3021/3022)
	Triangle	1μHz~1MHz
	Ramp	1μHz~1MHz

FSK Hop Frequency

The default Hop frequency for all waveform shapes is 100 Hz. A square wave with a duty cycle of 50% is used for the internal modulation waveform. The voltage level of the Trigger INPUT signal controls the output frequency when EXT is selected. When the Trigger INPUT signal is logically low the carrier frequency is output and when the signal is logically high, the hop frequency is output.

Panel Operation 1. Press the MOD key.



2. Press F3 (FSK).



3. Press F2 (Hop Freq).



4. The Hop Freq parameter will become highlighted in the Waveform Display area.

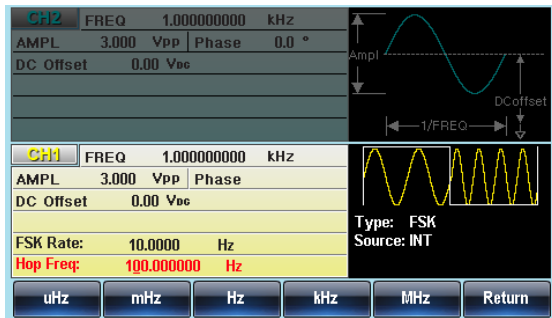

5. Use the selector keys and scroll wheel or number pad to enter the hop frequency.

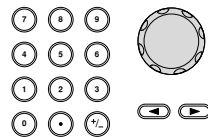

6. Press F1~F5 to select the frequency range.



Range	Waveform	Carrier Frequency
	Sine	1 μ Hz~30MHz (20MHz AFG-3021/3022)
	Square	1 μ Hz~30MHz (20MHz AFG-3021/3022)
	Triangle	1 μ Hz~1MHz
	Ramp	1 μ Hz~1MHz

FSK Rate

The FSK Rate function is used to determine the rate at which the output frequency changes between the carrier and hop frequencies. The FSK Rate function only applies to internal FSK sources.

- Panel Operation 1. Select MOD.



2. Press F3 (FSK).



3. Press F3 (FSK Rate).



4. The FSK Rate parameter will become highlighted in the waveform display area.

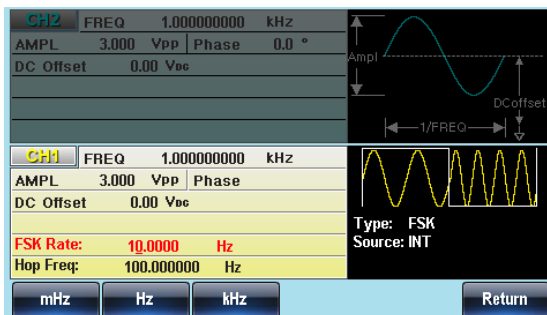

5. Use the selector keys and scroll wheel or number pad to enter the FSK rate.

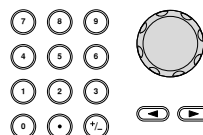

6. Press F1~F5 to select the frequency unit.



Range	FSK Rate	2mHz~100kHz
	Default	10Hz

Note If an external source is selected, FSK Rate settings are ignored.

FSK Source

The AFG-30XX accepts internal and external FSK sources, with internal as the default source. When the FSK source is set to internal, the FSK rate is configured using the FSK Rate function. When an external source is selected the FSK rate is equal to the frequency of the Trigger INPUT signal on the rear panel.

- Panel Operation
1. Press the MOD key.



2. Press F3 (FSK).



3. Press F1 (Source).



4. To select the source, press F1 (Internal) or F2 (External).



Note

Note that the Trigger INPUT terminal cannot configure edge polarity.

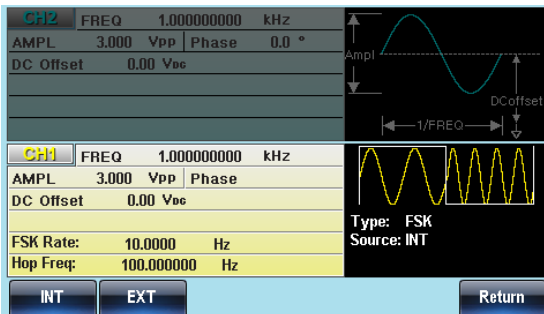

Phase Modulation (PM)

A PM waveform is produced from a carrier waveform and a modulating waveform. The phase of the carrier waveform is modulated by the magnitude of the modulating waveform. When using the function generator, only one type of modulated waveform can be created at any one time for the selected channel.

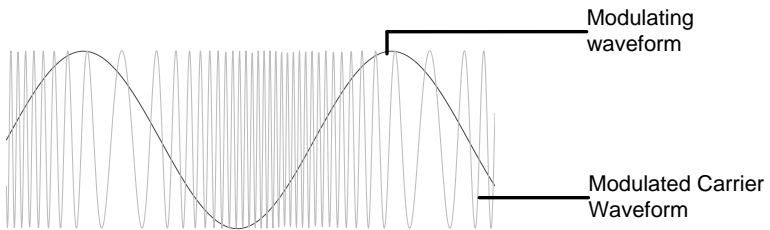

Selecting Phase Modulation (PM)

When PM is selected, the modulated waveform depends on the carrier frequency, the output amplitude and offset voltage.

Panel Operation 1. Press the MOD key.



2. Press F4 (PM).

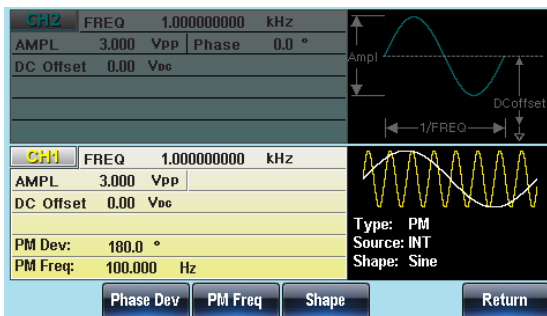

PM Carrier Shape

Background The default waveform shape is set to sine. Sine, square, triangle or ramp waveforms can be used as the carrier shape. Noise, Pulse, ARB, DC and Harmonic waveforms cannot be used as a carrier wave.

Panel Operation 1. Press the Waveform key.





2. Press F1~F5 to choose the carrier wave shape. (bar F4)



Range Carrier Shape Sine, Square, Triangle, Ramp.

PM Carrier Frequency

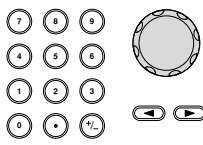







The maximum carrier frequency depends on the carrier shape selected. The default carrier frequency for all carrier shapes is 1kHz.

- Panel Operation
- To select the carrier frequency, press the **FREQ/Rate** key. 
 - The **FREQ** parameter will become highlighted in the parameter window.
 - Use the selector keys and scroll wheel or number pad to enter the carrier frequency. 
 - Press **F2~F6** to select the frequency unit. 

Range	Carrier Shape	Carrier Frequency
	Sine	1 μ Hz~30MHz (20MHz AFG-3021/3022)
	Square	1 μ Hz~30MHz (20MHz AFG-3021/3022)
	Triangle	1 μ Hz~1MHz
	Ramp	1 μ Hz~1MHz
	Default frequency	1 kHz

PM Wave Shape

The function generator can accept internal as well as external sources. The AFG-30XX has sine, square, triangle, positive and negative ramps (UpRamp, DnRamp) as the internal modulating waveform shapes. Sine is the default wave shape.

- Panel Operation
1. Select MOD. 
 2. Press F4 (PM).  
 3. Press F4 (Shape).  
 4. Press F1~F5 to select the waveform shape.    

Note	Square wave	50% Duty cycle
	UpRamp	100% Symmetry
	Triangle	50% Symmetry
	DnRamp	0% Symmetry

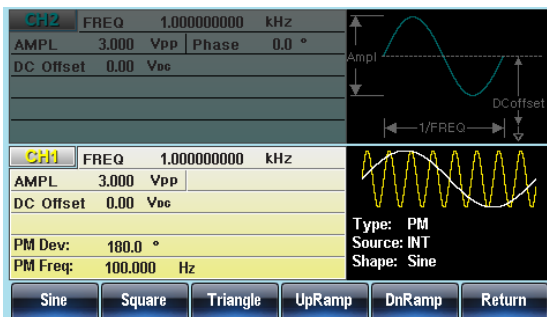

Modulation Frequency

The PM Freq parameter sets the modulation frequency for the phase modulation function when using an internal source.

Panel Operation 1. Press the MOD key.



2. Press F4 (PM).



3. Press F3 (PM Freq).



4. The PM Freq parameter will become highlighted in the waveform display panel.

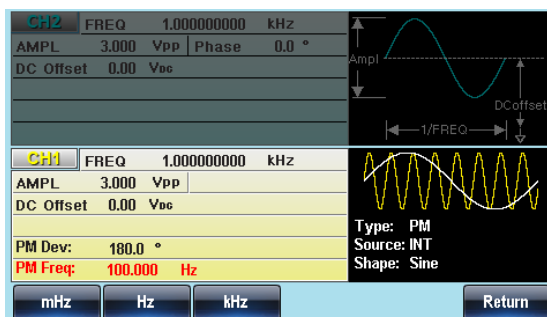

5. Use the selector keys and scroll wheel or number pad to enter the PM frequency.

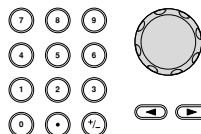

6. Press F1~F3 to select the frequency unit.



Range	Modulation frequency	2mHz~20kHz
	Default frequency	100Hz

Phase Modulation Deviation

The phase modulation deviation is the peak phase deviation of the modulating wave from the carrier wave.

Panel Operation 1. Press the MOD key.



2. Press F4 (PM).



3. Press F2 (Phase Dev).



4. The PM Dev parameter will become highlighted in the waveform display panel.

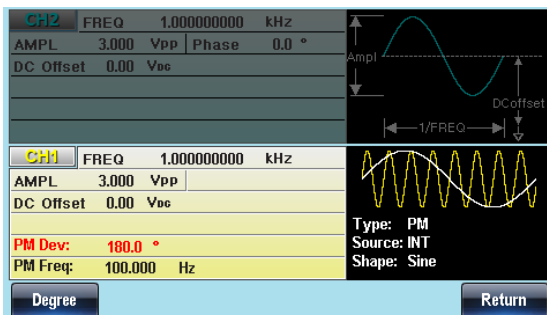

5. Use the selector keys and scroll wheel or number pad to enter the phase deviation.

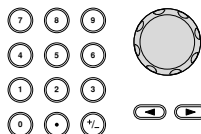

6. Press F1 to choose the degree units.



Range	PM Deviation	0~360 degrees
	Default	180 degrees

SUM Modulation

SUM modulation adds the modulating waveform to the carrier waveform. The amplitude of the modulating waveform is set as a percentage of the carrier amplitude.

Only one mode of modulation can be enabled at any one time for the selected channel. If SUM is enabled, any other modulation mode will be disabled. Likewise, burst and sweep modes cannot be used with SUM modulation and will be disabled when SUM is enabled.

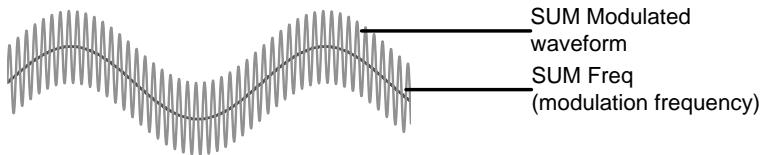

Selecting SUM Modulation

When selecting SUM, the carrier frequency, amplitude and frequency must be considered.

Panel Operation 1. Press the MOD key.



2. Press F5 (SUM).

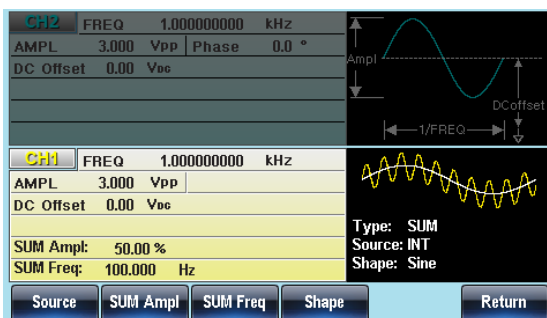

SUM Carrier Shape

Background The default carrier waveform shape is set to sine. The carrier can be set to Sine, Triangle, Pulse or Ramp. Triangle, Noise, Pulse, ARB, DC and Harmonic waveforms cannot be used as a carrier wave.

Panel Operation 1. Press the Waveform key.

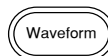



2. Press F1~F5 to choose the carrier wave shape. (bar F3)



Range Carrier Shape Sine, Triangle, Pulse, Ramp.

SUM Carrier Frequency

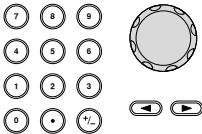
The maximum carrier frequency depends on the carrier shape selected. The default carrier frequency for all carrier shapes is 1kHz.



- Panel Operation
- To select the carrier frequency, press the **FREQ/Rate** key. 
 - The **FREQ** parameter will become highlighted in the parameter window.
 - Use the selector keys and scroll wheel or number pad to enter the carrier frequency. 
 - Press **F2~F6** to select the frequency unit. 



Range	Carrier Shape	Carrier Frequency
	Sine	1 μ Hz~30MHz (20MHz AFG-3021/3022)
	Triangle	1 μ Hz~1MHz
	Ramp	1 μ Hz~1MHz
	Default frequency	1 kHz



SUM Modulating Wave Shape



The modulating wave shapes for internal sources include sine, square, triangle, up ramp and down ramp. The default wave shape is sine.

- Panel Operation
- Press the **MOD** key. 

2. Press F5 (SUM).



3. Press F4 (Shape).



4. Press F1~F5 to select a waveform shape.

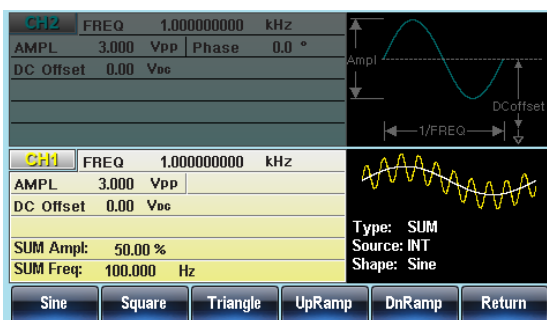







Range	Waveform	
	Square	50% Duty cycle
	UpRamp	100% Symmetry
	Triangle	50% Symmetry
	DnRamp	0% Symmetry





SUM Frequency

The SUM Frequency sets the frequency of the modulating waveform.

- Panel Operation
1. Select MOD.

 2. Press F5 (SUM).



 3. Press F3 (SUM Freq).

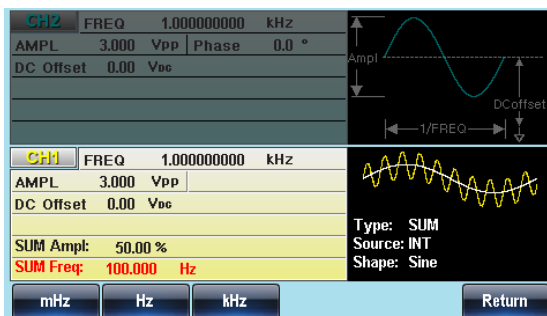

- The SUM Freq parameter will become highlighted in the Waveform Display area.

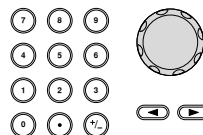

- Use the selector keys and scroll wheel or number pad to enter the SUM frequency.



- Press F1~F3 to select the frequency unit range.



Range	SUM Frequency	2mHz~20kHz
	Default	20kHz

SUM Amplitude

The SUM amplitude parameter sets the amplitude of the modulating waveform as a percentage of the carrier amplitude.

- Panel Operation
- Press the MOD key.



- Press F5 (SUM).



- Press F2 (SUM Ampl).



- The SUM Amplitude will become highlighted in the waveform display area.

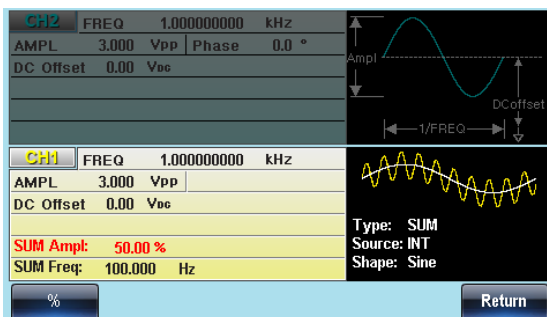

- Use the selector keys and scroll wheel or number pad to enter the SUM amplitude.

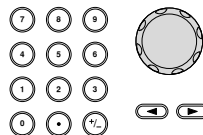

- Press F1 (%) to select percentage units.



Range	SUM amplitude	0% ~ 100%
	Default	50%

SUM Source

The AFG-30XX accepts internal and external modulation sources. Internal is the default source for SUM modulation sources.

- Panel Operation
- Press the MOD key.



- Press F5 (SUM).



- Press F1 (Source).



4. To select the source, press F1 (Internal) or F2 (External).



External Source Use the MOD INPUT terminal on the rear panel when using an external source.

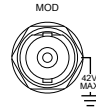

For AFG-3022/3032, using the CH1 or CH2 MOD input depends on which channel is used for modulation.

Note If an external modulation source is selected, the SUM amplitude is controlled by the $\pm 5V$ from the MOD INPUT terminal on the rear panel. For example, if SUM modulation is set to 100%, then the amplitude occurs at +5V, and the minimum amplitude at -5V.

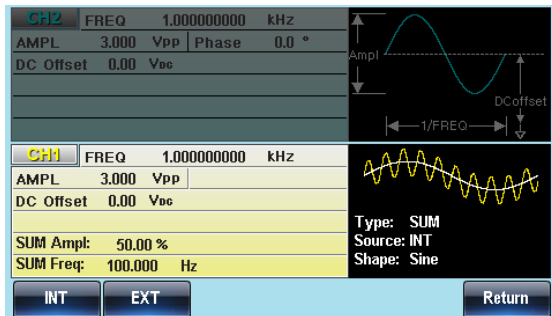

Pulse Width Modulation

For pulse width modulation the instantaneous voltage of the modulating waveform determines the width of the pulse waveform.

Only one mode of modulation can be enabled at any one time for the selected channel. If PWM is enabled, any other modulation mode will be disabled. Likewise, burst and sweep modes cannot be used with PWM and will be disabled when PWM is enabled.

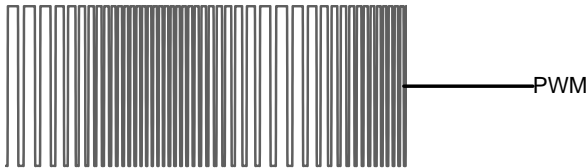

Selecting Pulse Width Modulation

When selecting PWM, the current setting of the carrier frequency, the amplitude modulation frequency, output, and offset voltage must be considered.

Panel Operation 1. Press the MOD key.



2. Press F2 (Square).



3. Press the MOD key.



4. Press F6 (PWM).

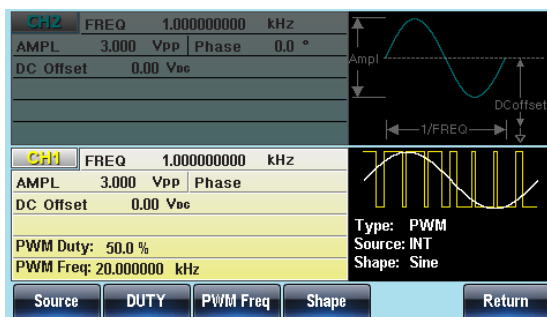



PWM Carrier Shape

PWM uses a square wave as the carrier shape. Other wave shapes cannot be used with PWM. If a carrier shape other than square is used with PWM, an error message will appear.

PWM Carrier Frequency

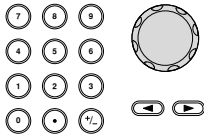

The carrier frequency depends on the square wave. The default carrier frequency is 1kHz.

- Panel Operation
- To select the carrier frequency, press the **FREQ/Rate** key. 
 - The **FREQ** parameter will become highlighted in the parameter window.
 - Use the selector keys and scroll wheel or number pad to enter the carrier frequency. 
 - Press **F2~F6** to select the PWM frequency unit. 

Range	Frequency	1μHz~30MHz (20MHz AFG-3021/3022)
-------	-----------	-------------------------------------

PWM Modulating Wave Shape

The modulating wave shapes for internal sources include sine, square, triangle, up ramp and down ramp. The default wave shape is sine.

- Panel Operation
- Press the **MOD** key. 
 - Press **F6 (PWM)**. 
 - Press **F4 (Shape)**. 

4. Press F1~F5 to select a waveform shape.



Range	Waveform	
	Square	50% Duty cycle
	UpRamp	100% Symmetry
	Triangle	50% Symmetry
	DnRamp	0% Symmetry

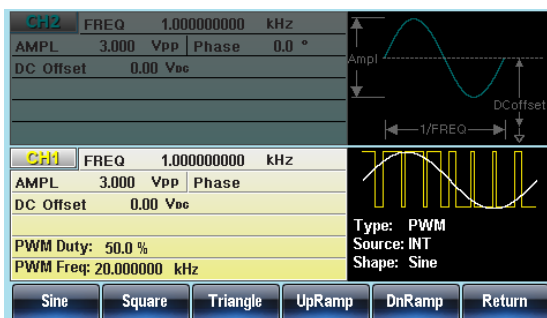

Modulating Waveform Frequency

- Panel Operation 1. Select MOD.



2. Press F6 (PWM).



3. Press F3 (PWM Frequency).



4. The PWM Freq parameter will become highlighted in the Waveform Display area.

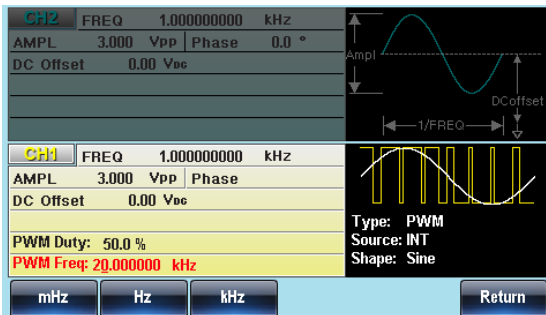

- Use the selector keys and scroll wheel or number pad to enter the PWM frequency.

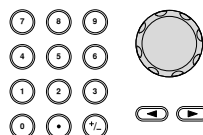

- Press F1~F3 to select the frequency unit range.



Range	PWM Frequency	2mHz~20kHz
	Default	20kHz

Modulation Duty Cycle

Duty function is used to set the duty cycle as percentage.

- Panel Operation 1. Press the MOD key.



- Press F6 (PWM).



- Press F2 (Duty).



- The Duty parameter will become highlighted in the waveform display area.

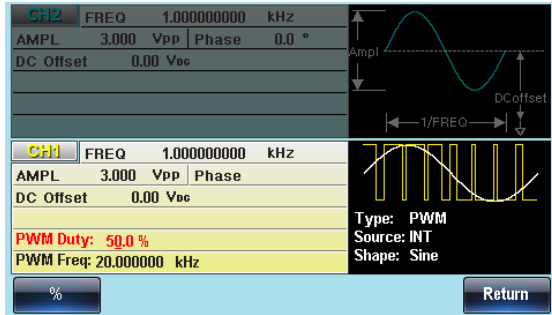

5. Use the selector keys and scroll wheel or number pad to enter the Duty cycle.

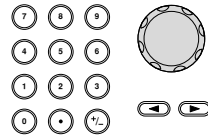

6. Press F1 (%) to select percentage units.



Range	Duty cycle	0% ~ 100%
	Default	50%

Note Pulse waveforms can be modulated with an external source using the external source function. When using an external source, the pulse width is controlled by the $\pm 5V$ MOD INPUT terminal.

PWM Source

The AFG-30XX accepts internal and external PWM sources. Internal is the default source for PWM sources.

- Panel Operation 1. Press the MOD key.



2. Press F6 (PWM).



3. Press F1 (Source).



4. To select the source, press F1 (Internal) or F2 (External).



External Source

Use the MOD INPUT terminal on the rear panel when using an external source.

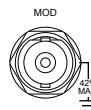

For AFG-3022/3032, using the CH1 or CH2 MOD input depends on which channel is used for modulation.

Note

If an external modulation source is selected, pulse width modulation is controlled by the $\pm 5V$ from the MOD INPUT terminal on the rear panel. For example, if duty is set to 100%, then the maximum pulse width occurs at +5V, and the minimum pulse width at -5V.

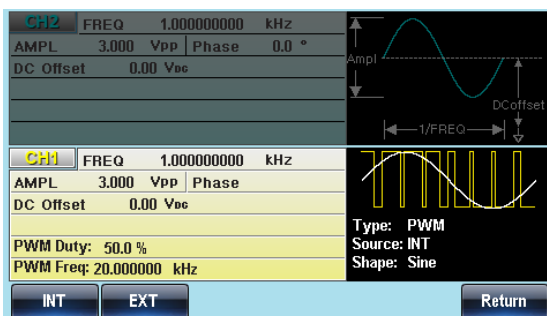

Sweep

The function generator can perform frequency sweeps for sine, square, ramp and triangle waveforms or amplitude sweeps for sine, square, triangle, pulse, ramp, noise and ARB waveforms. When Sweep mode is enabled, Burst or any other modulation modes will be disabled for the selected channel. When sweep is enabled, burst mode is automatically disabled.

When the sweep type is set to frequency, the function generator will sweep from a start frequency to a stop frequency over a number of designated steps.

When the sweep type is set to amplitude, the function generator will sweep from a start amplitude to a stop amplitude over a set sweep time.

If manual or external sources are used, the function generator can be used to output a single sweep. The step spacing of the sweep can be linear or logarithmic. The function generator can also sweep up or sweep down in frequency or amplitude. Frequency Sweep and Amplitude Sweep cannot be used at the same time.

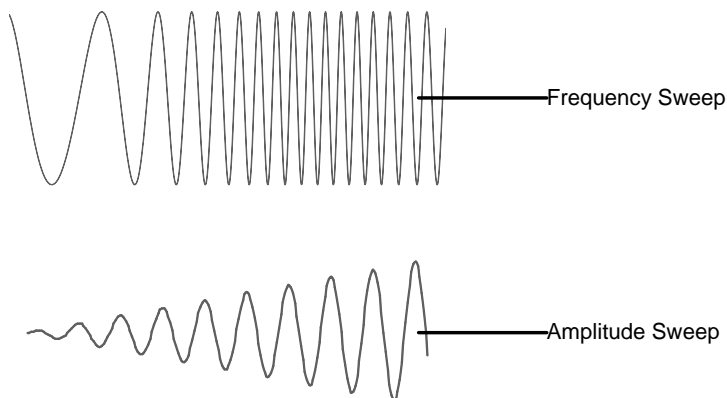

Selecting Sweep Mode

The Sweep button is used to output a sweep. If no settings have been configured, the default settings for output amplitude, offset and frequency are used.



Sweep Type

Sweep type is used to select between whether a frequency or amplitude sweep is performed.

Panel Operation 1. Press the Sweep key.



2. Press F2 (Type/MOD).



3. Press F1 (Type).



4. To select frequency or amplitude sweep, press F1 (Frequency) or F2 (Ampltd).

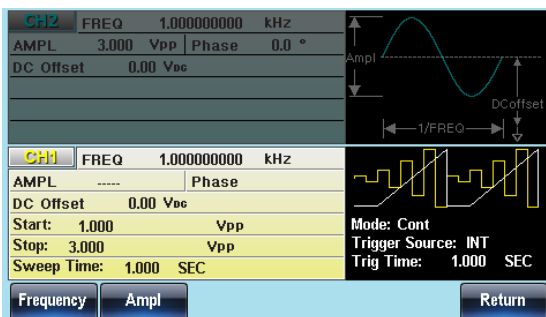

Example

Frequency

Amplitude

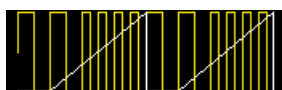

Setting Start and Stop Frequency/Amplitude

The start and stop frequencies/amplitudes define the upper and lower sweep limits. The function generator will sweep from the start through to the stop frequency/amplitude and cycle back to the start frequency/amplitude. The sweep is phase continuous over the full sweep frequency range (100µHz-30MHz). For amplitude sweep mode, the amplitude ranges from 1mVpp-10Vpp.

Panel Operation 1. Press the SWEEP key.



2. To select the start or stop frequency/amplitude, press F3 (Start) or F4 (Stop).



3. The Start or Stop parameter will become highlighted in the waveform display area.

Start
(Frequency shown)



Stop
(Amplitude shown)

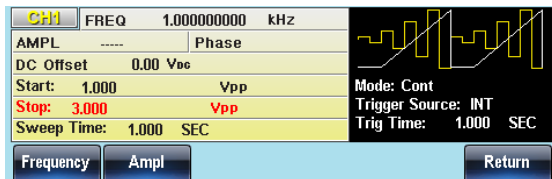

4. Use the selector keys and scroll wheel or number pad to enter the Stop/Start frequency/amplitude.

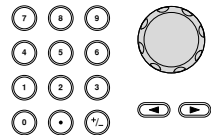

5. Press F1~F5 to select the Start/Stop frequency units or amplitude units.
- 

Range (Frequency)	Sweep Range	1μHz~30MHz (Sine/Square) (20MHz AFG-3021/3022) 1μHz~1MHz (Ramp/Triangle)
	Start - Default	100Hz
	Stop - Default	1kHz
Range (Amplitude)	Sweep Range	1mVpp~10Vpp (into 50Ω)
	Start - Default	1Vpp
	Stop - Default	3Vpp



Note

To sweep from low to high frequencies or amplitudes, set the start frequency/amplitude less than the stop frequency/amplitude.

To sweep from high to low frequencies or amplitude, set the start frequency/amplitude greater than the stop frequency/amplitude.

Center Frequency and Span

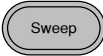
A center frequency and span can be set to determine the upper and lower sweep limits (start/stop). This setting is only available when Sweep Type = Frequency.

- Panel Operation**
1. Press the SWEEP key.
 
 2. Press F6 (More).
 
 3. To select span or center, press F1 (Span) or F2 (Center).
 

- The Span or Center parameter will become highlighted in the Waveform Display area.

Span

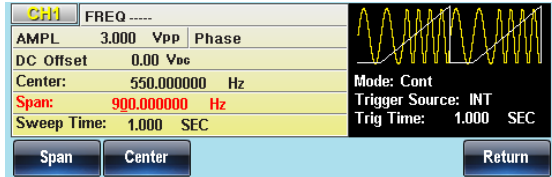

Center

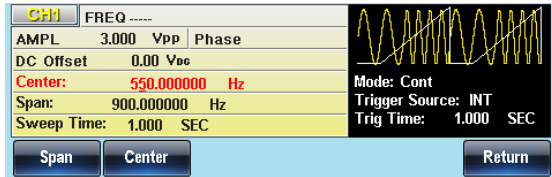

- Use the selector keys and scroll wheel or number pad to enter the Span/Center frequency.

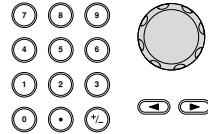

- Press F1~F5 to select the Start/Stop frequency units.



Range	Center	1μHz~30MHz (Sine/Square)
	Frequencies	(20MHz AFG-3021/3022)
		1μHz~1MHz (Triangle/Ramp)
	Span Frequency	DC~30MHz (Sine/Square)
		(20MHz AFG-3021/3022)
		DC ~1MHz (Triangle/Ramp)
	Center - Default	550Hz
	Span – Default	900Hz

Note To sweep from low to high frequencies, set a positive span.
To sweep from high to low frequencies, set a negative span.

Sweep Mode

Sweep mode is used to select between continuous or gated sweeps. When set to continuous mode, the sweep function will be continuously output, according to the internal trigger. When set to gated mode the sweep output will be synchronized to the trigger input.

Panel Operation 1. Press the SWEEP key.

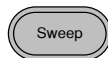

2. Press F2 (Type/MOD).



3. Press F2 (Mode).



4. To select Cont or Gated, press F1 (Cont) or F2 (Gated).

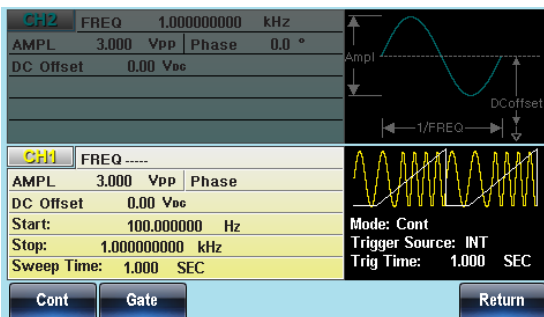

Sweep Function

Sweep function is used to select between linear or logarithmic sweeping. Linear sweeping is the default setting.

Panel Operation 1. Press the SWEEP key.

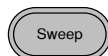

2. Press F2 (Type/MOD).



3. Press F3 (Function).



4. To select linear or logarithmic sweep, press F1 (Linear) or F2 (Log).

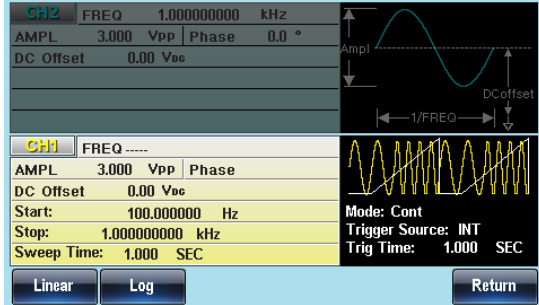

Sweep Waveform Type

The sweep waveform type sets the shape of the sweep waveform that is created.

The sawtooth waveform creates a swept waveform in the shape of a sawtooth wave:

The triangle waveform creates a waveform in the shape of a shuttlecock:

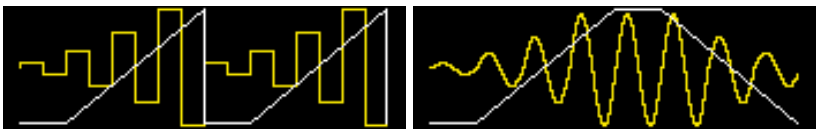

- Panel Operation
1. Press the SWEEP key.

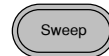

2. Press F2 (Type/MOD).



- To select waveform type, press F4 (Sawtooth) or F5 (Triangle).

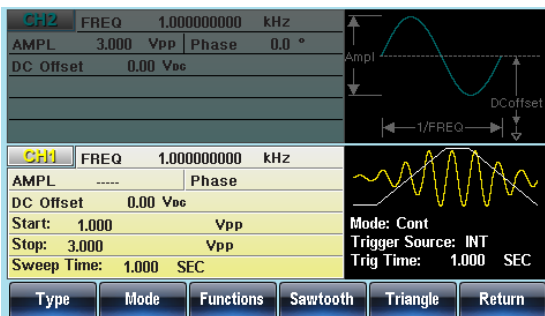

Sweep Time

The sweep time is used to determine how long it takes to perform a sweep from the start to stop frequencies/amplitude. The function generator automatically determines the number of discrete frequencies or the amplitude used in the sweep depending on the duration of the sweep.

- Panel Operation
- Press the SWEEP key.

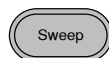

- Press F5 (SWP Time).



- The Sweep Time parameter will become highlighted in the Waveform display area.

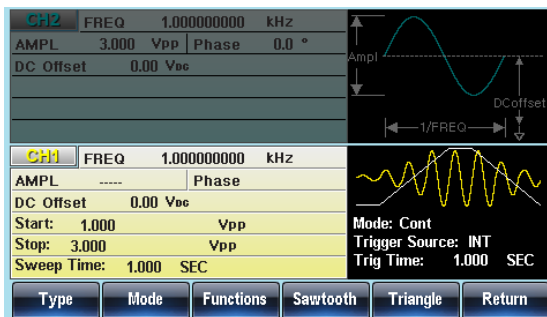

4. Use the selector keys and scroll wheel or number pad to enter the Sweep time.

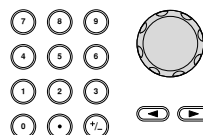

5. Press F1~F2 to select the time unit.



Range	Sweep time	1ms ~ 500s
	Default	1s

Sweep Trigger Source

In sweep mode the function generator will sweep each time a trigger signal is received. After a sweep output has completed, the function generator outputs the start frequency and waits for a trigger signal before completing the sweep. The trigger source can either be an internal (settable trigger interval) trigger, a manual trigger or an external trigger. The default trigger source is internal.

Panel Operation 1. Press the SWEEP key.



2. Press F1 (TRIG Type).



3. To select the source, press F1 (INT), F2 (EXT) or F3 (Manual).



Internal Trigger 1. If INT (internal trigger) was selected, press F5 (TRIG Time) to set the timing interval for the internal trigger.



2. TRIG Time will become highlighted in the waveform display area.

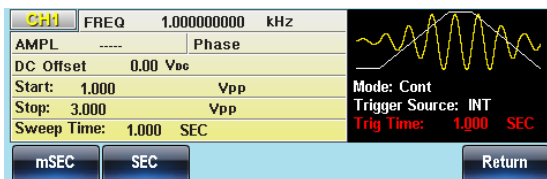

3. Use the selector keys and scroll wheel or number pad to enter the trigger interval time.

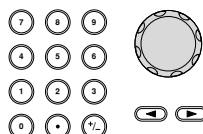

4. Press F1~F2 to choose the time unit.



Range Internal Trigger Interval 1ms ~ 500s

- Manual Trigger 5. If Manual was selected, press F1 (Trigger) to manually start each sweep.



6. Press F6 (Return) to return to the menu.



Note

Using the Internal source will produce a continuous sweep at an interval according to the trigger time settings.

With an external source, a sweep is output each time a trigger pulse (TTL) is received from the Trigger INPUT terminal on the rear panel.

The trigger period must be equal to or greater than the sweep time plus 1ms.

The screenshot displays the modulation menu interface. It is divided into several sections:

- CH2 Settings:**
 - FREQ: 1.00000000 kHz
 - AMPL: 3.000 Vpp
 - Phase: 0.0 °
 - DC Offset: 0.00 Vdc
- CH1 Settings:**
 - FREQ: 1.00000000 kHz
 - AMPL: ----
 - Phase: ----
 - DC Offset: 0.00 Vdc
 - Start: 1.000 Vpp
 - Stop: 3.000 Vpp
 - Sweep Time: 1.000 SEC
- Waveforms:**
 - Top: A single cycle of a sine wave with labels for 'Ampl' (peak-to-peak), 'DCoffset', and '1/FREQ' (period).
 - Bottom: A continuous sweep waveform.
- Mode and Trigger Settings:**
 - Mode: Cont
 - Trigger Source: INT
 - Trig Time: 1.000 SEC
- Control Buttons:** INT, EXT, Manual, OFF, TRIG Time, Return

Burst Mode

The function generator can create a waveform burst with a designated number of cycles. Burst mode supports sine, square, triangle, pulse, ramp, noise (gated burst mode only) waveforms*.

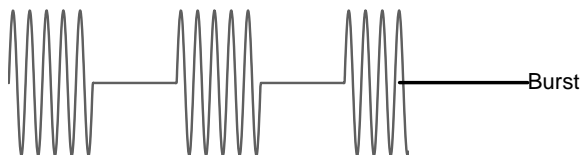

*The ARB function also has an N-Cycle Burst mode, however it is not accessible from the Burst function mode.

Selecting Burst Mode

When burst mode is selected, any modulation or sweep modes will be automatically disabled for the selected channel. If no settings have been configured, the default settings for output amplitude, offset and frequency are used.



Burst Modes

Burst mode can be configured using Triggered (N Cycle mode) or Gated mode. Using N Cycle/Triggered mode, each time the function generator receives a trigger, the function generator will output a specified number of waveform cycles (burst). After the burst, the function generator will wait for the next trigger before outputting another burst. N Cycle is the default Burst mode. Triggered mode can use internal or external triggers.

The alternative to using a specified number of cycles, Gate mode, uses the external trigger to turn on or off the output. When the Trigger INPUT signal is high, waveforms are continuously output.

When the Trigger INPUT signal goes low, the waveforms will stop being output after the last waveform completes its period. The voltage level of the output will remain equal to the starting phase of the burst waveforms, ready for the signal to go high again.

Burst Mode	Burst Count	Burst Period	Phase	Trigger Source
Triggered (Int)	Available	Available	Available	Immediate
Triggered (Ext)	Available	Unused	Available	EXT
Gated pulse (Ext)	Unused	Unused	Available	Unused

In Gated mode, burst count, burst cycle and trigger source are ignored. If a trigger is input, then the trigger will be ignored and will not generate any errors.

Panel Operation 1. Press the Burst key.



2. Select either N Cycle (F1) or Gate (F2).





Burst Frequency

In the N Cycle and Gated modes, the waveform frequency sets the repetition rate of the burst waveforms. In N-Cycle mode, the burst is output at the waveform frequency for the number of cycles set. In Gated mode the waveform frequency is output while the trigger is high. Burst mode supports sine, square, triangle or ramp waveforms.

Panel Operation 1. Press the FREQ/Rate key.

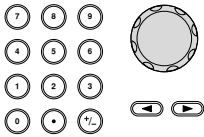

2. The FREQ parameter will become highlighted in the parameter window.



- 3. Use the selector keys and scroll wheel or number pad to enter the frequency.
 
- 4. Press F2~F6 to choose the frequency unit.
 

Range	Frequency	1uHz~30MHz (20MHz AFG-3021/3022)
	Frequency – Ramp	1uHz~1MHz
	Default	1kHz

Note Waveform frequency and burst period are not the same. The burst period is the time between the bursts in N-Cycle mode.

Burst Cycle/Burst Count

The burst cycle (burst count) is used to define the number of cycles that are output for a burst waveform. Burst cycle is only used with N-cycle mode (internal, external or manual source). The default burst cycle is 1.

- Panel Operation**
- 1. Press the Burst key.
 
 - 2. Press F1 (N Cycle).
 
 - 3. Press F1 (Cycles).
 
 - 4. The Cycles parameter will become highlighted in the Waveform Display area.

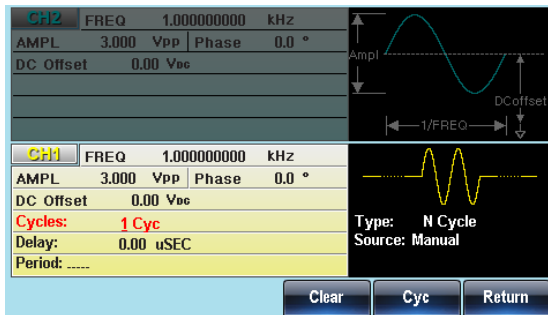

- Use the selector keys and scroll wheel or number pad to enter the number of cycles.

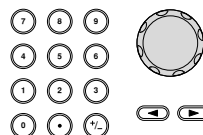

- Press F5 to select the Cyc unit.



Range	Cycles	1~1,000,000
-------	--------	-------------





Note Burst cycles are continuously output when the internal trigger is selected. The burst period determines the rate of bursts and the time between bursts.

Burst cycle must be less than the product of the burst period and wave frequency.

$$\text{Burst Cycle} < (\text{Burst Period} \times \text{Wave Frequency})$$

If gated burst mode is selected, burst cycle is ignored. Though, if the burst cycle is changed remotely whilst in gated mode, the new burst cycle is remembered when used next.

Infinite Burst Count

- Panel Operation
1. Press the Burst key. 
 2. Press F1 (N Cycle).  
 3. Press F2 (Infinite).  

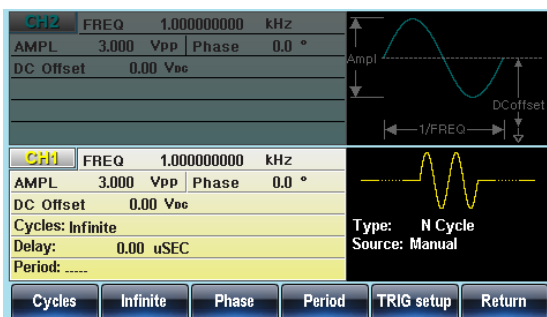

Note Infinite burst is only available when using manual triggering.

Above 25MHz, Infinite burst is only available with square and sine waveforms.



Burst Period

The burst period is used to determine the time between the start of one burst and the start of the next burst. It is only used for internally triggered bursts.

- Panel Operation
1. Press the Burst key. 
 2. Press F1 (N Cycle).  

3. Press F4 (Period).



4. The Period parameter will become highlighted in the Waveform Display area.

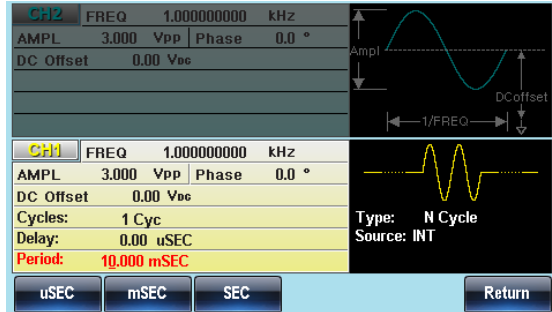

5. Use the selector keys and scroll wheel or number pad to enter period time.

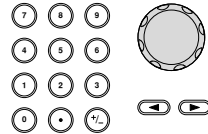

6. Press F1~F3 to choose the period time unit.



Range	Period time	1us~500s
	Default	10ms

Note Burst period is only applicable for internal triggers. Burst period settings are ignored when using gated burst mode or for external and manual triggers. The burst period must be large enough to satisfied the condition below:

$$\text{Burst Period} > \text{Burst Count} / \text{Wave frequency} + 200\text{ns.}$$

Burst Phase

Burst Phase defines the starting phase of the burst waveform. The default is 0°.

Panel Operation 1. Press the Burst key.



2. Press F1 (N Cycle).



3. Press F3 (Phase).



4. The Phase parameter will become highlighted in the Waveform Display area.

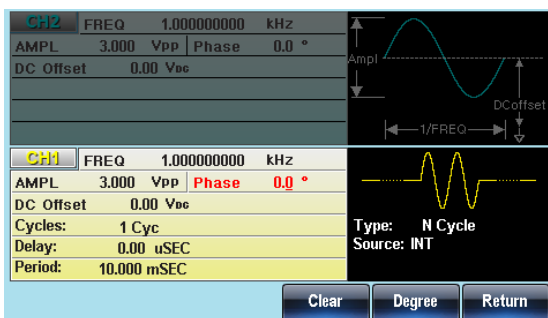

5. Use the selector keys and scroll wheel or number pad to enter the phase.

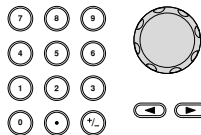

6. Press F5 (Degree) to select the phase unit.



Range	Phase	-360° ~ +360°
	Default	0°

Note When using sine, square, triangle or ramp waveforms, 0° is the point where the waveforms are at zero volts.

0° is the starting point of a waveform. For sine, square or Triangle, Ramp waveforms, 0° is at 0 volts (assuming there is no DC offset).

Burst Phase is used for both N cycle and Gated burst modes. In gated burst mode, when the Trigger INPUT signal goes low the output is stopped after the current waveform is finished. The voltage output level will remain equal to the voltage at the starting burst phase.

When using square waves in burst mode, the duty cycle in the first and last period may have some errors under specific phase settings due to the frequency response.

Burst Trigger Source

Each time the function generator receives a trigger in triggered burst (N-Cycle) mode, a waveform burst is output. The number of waveforms in each burst is designated by the burst cycle (burst count). When a burst has completed, the function generator waits for the next trigger. Internal source is the default triggered burst (N-cycle) mode on power up.

Panel Operation 1. Press the Burst key.



2. Press F1 (N Cycle).



3. Press F5 (TRIG setup).



4. Choose a trigger type by pressing F1 (INT), F2 (EXT) or F3 (Manual).



Manual Triggering

5. If a manual source is selected, the trigger soft-key (F1) must be pressed each time to output a burst.

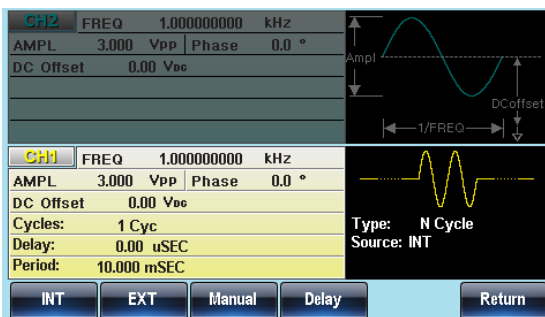

Note When the internal trigger source is chosen, the burst is output continuously at a rate defined by the burst period setting. The interval between bursts is defined by the burst period.

When the external trigger is selected the function generator will receive a trigger signal (TTL) from the Trigger INPUT terminal on the rear panel. Each time the trigger is received, a burst is output (with the defined number of cycles). If a trigger signal is received during a burst, it is ignored.

When using the manual or external trigger only the burst phase and burst cycle/count are applicable, the burst period is not used.

A time delay can be inserted after each trigger, before the start of a burst.

Burst Delay

Panel Operation 1. Press the Burst key.



2. Press F1 (N Cycle).



3. Press F5 (TRIG setup).



4. Press F4 (Delay).



5. The Delay parameter will become highlighted in the Waveform Display area.

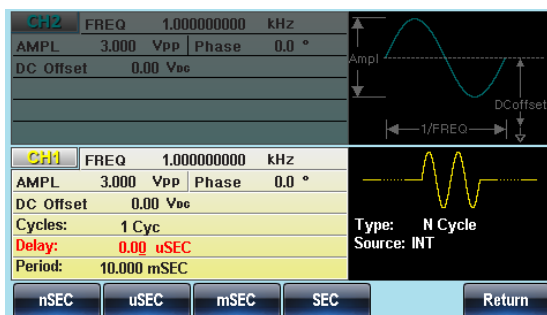

6. Use the selector keys and scroll wheel or number pad to enter the delay time.

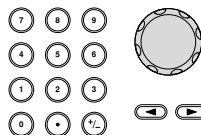





7. Press F1~F4 to choose the delay time unit.



Range	Delay time	0s~100s
	Default	0s





Gated Trigger Polarity

The Polarity setting sets the polarity of the input trigger signal for the gated mode.

- Panel Operation
1. Press the Burst key. 
 2. Press F2 (Gate). 
 3. Press F1 (Polarity). 
 4. Select either Pos (F1) or Neg (F2). 

Gated Trigger Phase

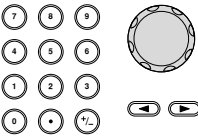
The phase setting for gated burst mode sets the starting phase of the outputted burst waveform.

- Panel Operation
1. Press the Burst key. 
 2. Press F2 (Gate). 
 3. Press F2 (Phase). 
 4. Use the selector keys and scroll wheel or number pad to enter the phase. 
 5. Press F5 (Degree) to select the phase unit. 

Range	Phase	-360°~+360°
	Default	0°

S SECONDARY SYSTEM

FUNCTION SETTINGS

The secondary system functions are used to store and recall settings, set the LAN/USB/GPIB settings, view the software version, update the firmware, perform self calibration, set the interface type, change the language, set the output impedance, configure DSO link and other miscellaneous functions.

Save, Recall or Delete	159
Selecting the Remote Interface	163
GPIB Interface	163
LAN Interface	164
LAN Host Name	166
USB Interface	167
System and Settings	168
Viewing and Updating the Software & Firmware Version	168
Language Selection	169
Setting the Beeper Sound	170
Display Suspend	171
Display Brightness	171
Reference Clock Sources	172
Setting the output impedance - AFG-3021/3031	174
DSO Link - AFG-3021/3031	175

Save, Recall or Delete

The AFG-3021, AFG-3022, AFG-3031 & AFG-3032 have non-volatile memory to store instrument state and ARB data. There are 10 memory files numbered 0~9. Each memory file can either store arbitrary waveform data (ARB), settings or both. When data (ARB or Setting data) is stored in a memory file, the data will be shown in red. If a file has no data, it will be shown in blue.

Save/Recall properties	ARB
	<ul style="list-style-type: none"> • Rate • Frequency • Length • Display horizontal
	Setting
	<ul style="list-style-type: none"> • Functions <ul style="list-style-type: none"> • Waveform • Frequency • Pulse Width • Pulse rise time • Pulse fall time • Square wave Duty • Ramp Symmetry • Amplitude • Amplitude unit • DC offset(DC waveform only) • Offset • Modulation type • Beep setting • Impedance • Main output • FM <ul style="list-style-type: none"> • Source • Shape • Deviation • FM frequency • FSK <ul style="list-style-type: none"> • Source • Shape • Rate • Hop frequency • PM <ul style="list-style-type: none"> • Shape • Phase deviation • PM frequency • SUM <ul style="list-style-type: none"> • Source • Shape

- Harmonic order settings
 - Harmonic display
 - Sweep
 - Source
 - Type
 - Time
 - Start frequency
 - Stop frequency
 - Center frequency
 - Span frequency
 - Start amplitude
 - Stop amplitude
 - AM
 - Source
 - Shape
 - Depth
 - AM frequency
 - SUM amplitude
 - SUM frequency
 - PWM
 - Source
 - Shape
 - Duty
 - Frequency
 - Burst Type
 - Source
 - Type
 - Cycles
 - Phase
 - Period
 - Delay
- Other
- Interface
 - Display
 - Phase
 - Dual channel settings

Panel Operation 1. Press the UTIL key.



2. Press F1 (Memory).



- Use the scroll wheel to highlight a memory file (Memory0 ~ Memory9).

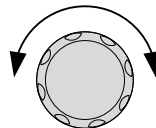

Path: Memory:Memory0:			
Memory0:	ARB	Setting	ARB+Setting
Memory1:	ARB	Setting	ARB+Setting
Memory2:	ARB	Setting	ARB+Setting
Memory3:	ARB	Setting	ARB+Setting
Memory4:	ARB	Setting	ARB+Setting
Memory5:	ARB	Setting	ARB+Setting
Memory6:	ARB	Setting	ARB+Setting
Memory7:	ARB	Setting	ARB+Setting
Memory8:	ARB	Setting	ARB+Setting
Memory9:	ARB	Setting	ARB+Setting

Store Recall Delete Delete All

- Choose a file operation to perform on the memory location:



Press F1 to store a file, press F2 to recall a file, or press F3 to delete a file.

- Use the scroll wheel to now select the data type to save/recall/delete. (ARB, Setting, ARB+Setting)

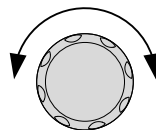

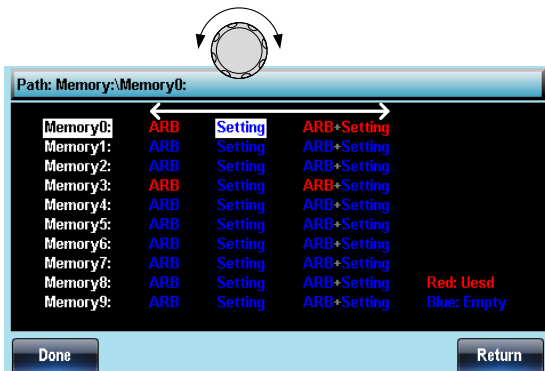

- Press F5 (Done) to complete the operation.



Range	Memory file	Memory0 ~ Memory9
	Data type	ARB, Setting, ARB+Setting

- To delete all the files for Memory0~Memory9, press F4.



- Press F1 (Done) to confirm the deletion of all files.









Selecting the Remote Interface



The AFG-3021, AFG-3022, AFG-3031 & AFG-3032 has LAN, GPIB and USB interfaces for remote control. Only one remote interface can be used at any one time.

GPIB Interface

Background When using the GPIB interface, a GPIB address must be specified. The default GPIB interface is 10.

- Panel Operation**
1. Press the UTIL key. 
 2. Press F2 (Interface).  
 3. Press F1 (GPIB).  
 4. Press F1 (Address)  
 5. GPIB will become highlighted.

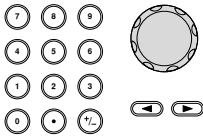





- 6. Use the selector keys and scroll wheel or number pad to enter the GPIB address.
 
- 7. Press F5 (Done) to confirm the GPIB address.
 

Range	GPIB address	1~30
-------	--------------	------

LAN Interface

Background When using the LAN interface, an IP must be specified (DHCP, Auto IP or manually configured).

- Panel Operation**
- 1. Press the UTIL key.
 
 - 2. Press F2 (Interface).
 
 - 3. Press F3 (LAN).
 
 - 4. Press F2 (Config).
 
 - 5. Choose how to configure the IP address. Press F1 (DHCP), F2 (Auto IP) or F3 (Manual).
 

Range	DHCP	Use DHCP to automatically configure the IP address of the unit for networks with a DHCP server.
	Auto IP	Use Auto IP to automatically configure the IP address of the unit when it is directly connected to a host PC via an Ethernet cable.
	Manual	Manually configure the IP address.

6. If Manual was selected, set F1 (IP Addr), F2 (NetMask) and F3 (Gateway) in turn.



7. The IP address, net mask or gateway settings become highlighted in the parameter window.



8. Use the number pad to enter the IP address, Net mask or gateway. Use the decimal point as a field separator.

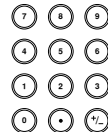

9. Press F5 (Done) to confirm the settings.



10. Finally, press F5 (Done) to confirm all the IP configuration settings.



LAN Host Name

Background The following describes how to set the host name for the unit when used in the LAN interface.

Panel Operation 1. Press the UTIL key.



2. Press F2 (Interface).



3. Press F3 (LAN).



4. Press F2 (Config).



5. Press F4 (HostName) to set the host name for the unit.



6. The Host Name settings become highlighted in the parameter window.

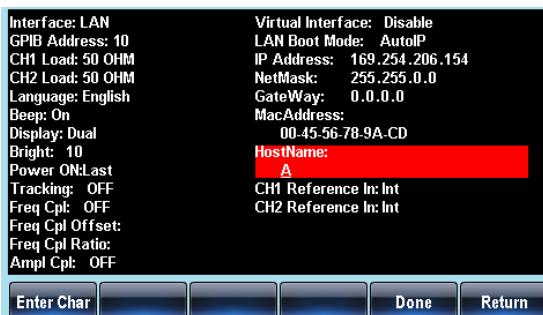

7. Use the scroll wheel to scroll through each character.

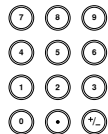

8. Press F1 (Enter Char) to select a character and continue to the next character.



9. Press F5 (Done) to confirm the host name.



USB Interface

Background The following shows how to configure the meter for remote control via the USB interface.

Panel Operation 1. Press the UTIL key.



2. Press F2 (Interface).



3. Press F2 (USB).









System and Settings

There are a number of miscellaneous settings such as language options, display options, clock source as well as software and firmware settings that can be configured.



Note: The location of the “System” soft-key is different for the single and dual channel models. On the AFG-3021/3031, the “System” soft-key is mapped to F4, rather than F5, as on the AFG-3022/3032.

Viewing and Updating the Software & Firmware Version

- | | | |
|-----------------|-------------------------|---------------------------------------------------------------------------------------------------------------------------------------------------------------------|
| Panel Operation | 1. Press the UTIL key. |  |
| | 2. Press F3 (Cal.). |   |
| | 3. Press F2 (Software). |   |

- | | | |
|--------------|-----------------------------------------------------------------|---------------------------------------------------------------------------------------------------------------------------------------------------------------------|
| View Version | 4. To view the software and firmware version, press F1(Version) |   |
|--------------|-----------------------------------------------------------------|---------------------------------------------------------------------------------------------------------------------------------------------------------------------|

The version information will be shown on screen:
Instrument, Version, FPGA Revision, Bootload version, Serial number.

- | | | |
|----------------------------|-------------------------------------------------------------------------------------------------------------------------------------------|-------------------------------------------------------------------------------------------------------------------------------------------------------------------------|
| Update Software & Firmware | 5. To update the software & firmware, insert a USB flash drive with the software/firmware file in the USB host drive. Press F2 (Upgrade). |   |
|----------------------------|-------------------------------------------------------------------------------------------------------------------------------------------|-------------------------------------------------------------------------------------------------------------------------------------------------------------------------|





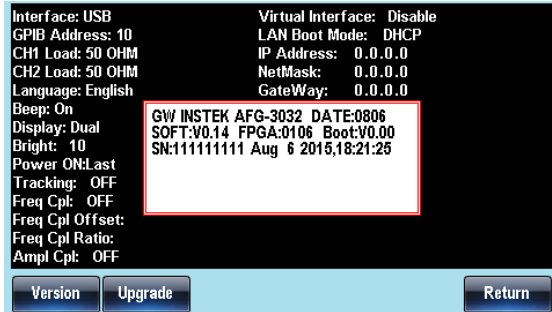

Note

The software/firmware uses a .bin extension (format: AFG***.bin).



Language Selection

Background The AFG-3021, AFG-3022, AFG-3031 and AFG-3032 can be operated in English, Traditional or Simplified Chinese. By default, the language is set to English.



- Panel Operation**
1. Press the UTIL key. 
 2. Press F4 (System) [F5 for AFG-3021/3031].  
 3. Press F1 (Language).  
 4. The Language parameter will become highlighted.



5. Select F1(Simplified Chinese), F2(English) or F3(Traditional Chinese) to choose the language.
 

Setting the Beeper Sound











Background The beeper sound can be set on or off for when a key is pressed or the scroll wheel is turned.

- Panel Operation**
1. Press the UTIL key.
 
 2. Press F4 (System) [F5 for AFG-3021/3031].
 
 3. Press F4 (Beep) to toggle the beeper on or off.
 
 4. The Beep parameter will become highlighted.









Display Suspend



Background This function will turn off the display until a front panel key is pressed. When a panel key is pressed the display will turn back on.

- Panel Operation**
1. Press the UTIL key. 
 2. Press F4 (System)[F5 for AFG-3021/3031].  
 3. Press F2 (Display Opt).  
 4. Press F1 (Display).  
 5. Select F1(Suspend) or F2(ON) to turn the display suspend feature on or off.    

Display Brightness

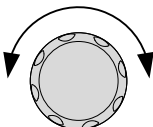
Background The brightness of the display can be set from the utility-system menu.

- Panel Operation
1. Press the UTIL key. 
 2. Press F4 (System)[F5 for AFG-3021/3031].  
 3. Press F2 (Display Opt).  
 4. Press F2 (Brightness).  
- Use the scroll wheel to set the brightness of the display. 

- | Range | Brightness | 1 (dim) ~ 10 (bright) |
|-------|------------|-----------------------|
| | | |
5. Press F1 (Enter) to finish setting the brightness.  

Reference Clock Sources

Background An external 10MHz reference signal can be used to replace the internal 10MHz clock signal. An external reference clock can be used to increase the accuracy or stability of the clock signal. It can also be used to sync different units together so that they operate on a synchronized clock. See page 186 for multi-unit syncing details.

The reference input is isolated from the chassis ground, with an isolation voltage of 42Vpk. This will prevent ground loops and other related interference.

The REF OUT port provides a sync signal of the internal reference clock. This port can be used to

synchronize other equipment to the internal reference clock of the function generator. See page 186 for details on multi-unit syncing.

Connection

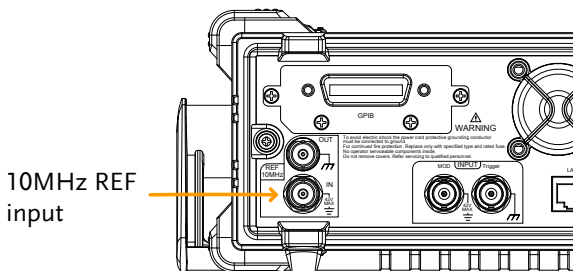

10MHz Reference Item	Specification
Output Specifications	
Output Voltage	1Vp-p/50Ω square wave
Output Impedance	50Ω, AC coupled
Output Frequency	10MHz

10MHz Reference Item	Specification
Input Specifications	
Input Voltage	0.5Vp-p to 5Vp-p
Input Impedance	1kΩ, unbalanced, AC coupled
Max. Allowed Input	± 10Vdc
Input Frequency	10MHz ±10Hz
Waveform	Sine or square (50±5% duty)
Ground Isolation	42Vpk max.

Panel Operation

1. Press the UTIL key.



2. Press F4 (System)[F5 for AFG-3021/3031].



3. Press F3 (Clk Source).



4. Select F1(INT) or F2(EXT) to choose the clock source.



Range	INT	Sets the internal clock as the reference clock.
	EXT	Sets an external 10MHz signal as the reference clock.

5. If F2(EXT) was selected as the clock source, Press F3(EXT Sync) to synchronize the unit to the external reference signal.



Setting the output impedance - AFG-3021/3031

Background The AFG-3021/3031 has selectable output impedances: 50Ω or high impedance. The default output impedance is 50Ω. The output impedances are to be used as a reference only. If the actual load impedance is different to that specified, then the actual amplitude and offset will vary accordingly.

Note The following describes how to set the output impedance on the AFG-3021 and the AFG-3031. To set the output impedance on the AFG-3022 or AFG-3032, please see page 179.

Panel Operation 1. Press the CH1 or CH2 key. 

2. Press F4 (Load). 



3. Select F1 (50 OHM) or F2 (High Z) to select the output impedance. 

DSO Link - AFG-3021/3031

Background DSO Link enables the AFG-3021/3031 to receive lossless data from a GDS-2000 Series DSO to create ARB data for the selected channel.

Note All models support the DSO Link function. However the menu tree operation varies between the single and dual channel models. The procedure here is only applicable to the AFG-3021/3031. For the AFG-3022 and AFG-3032, please see page 180.

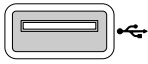

- Panel Operation**
1. Connect the AFG-3021/3031's USB host port to the GDS-2000's USB B device port.



 2. Press the CH1 or CH2 key.





 3. Press F6 (DSO Link).



 4. Press F1 (Search).

 5. To select the DSO channel, press F1 (CH1), F3 (CH2), F4 (CH3) or F5 (CH4). The acquired data can then be displayed.





~

6. After a few moments the AFG-3021/3031 will automatically switch over to the ARB function and the waveform that was saved from the DSO will be plotted as an ARB waveform.

See the ARB chapter to edit or save the resultant waveform.

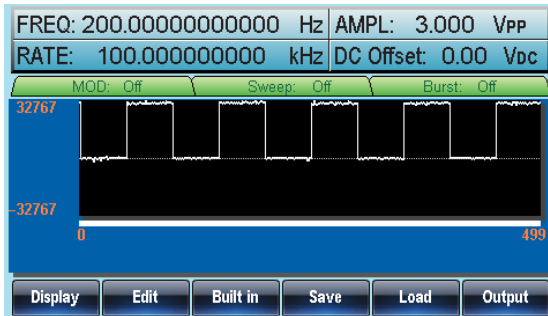

DUAL CHANNEL & MULTI-UNIT OPERATION

The dual channel section details how to operate the unit in dual channel mode (AFG-3022 & AFG-3032 only) and how to set any channel-specific settings. The multi-unit section describes how to sync multiple units together in a master-slave configuration.

Dual Channel Settings	178
Channel Phase Settings	178
Setting the output impedance	179
DSO Link	180
Frequency Coupling	181
Amplitude Coupling	183
Channel Tracking.....	184
Multi-Unit Syncing	186
Multi Unit Connection	186
Multi Unit Setup.....	188

Dual Channel Settings

There are a number of settings that only apply to the AFG-3022 and AFG-3032, such as channel tracking, DSO link, output impedance settings and channel phase settings for each channel.

Channel Phase Settings

Background The phase settings allow you to configure the start phase of a channel to one of 4 pre-set phase settings:

0 Phase	Quick set the phase of a channel to 0°.
Sync Int	Synchronizes the phase of both channels and sets the phase to 0°.
Degree	Sets the phase of the selected channel.
Align Phase	Aligns the timebase of both channels but doesn't change the phase deviation of the channels. In other words it re-calibrates the phase difference between both of the channels.

Panel Operation 1. Press the CH1 or CH2 key.





2. Press F5 (Phase).



3. To select the phase of the channel, press F1 (0 Phase), F2 (Sync Int), F4 (Degree) or F5 (Align Phase).

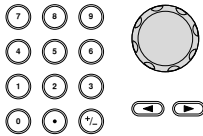

4. If Degree was selected, use the selector keys and scroll wheel or number pad to enter the phase.
 
5. Press F5 (Degree) again to set the phase unit.
 

Range	Degree	-180 ° to 180° (Sets the phase of the selected channel)
-------	--------	---------------------------------------------------------

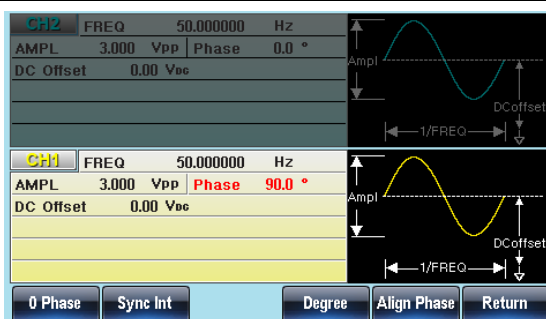







Setting the output impedance

Background The AFG-3022/ AFG-3032 has selectable output impedances for each channel: 50Ω or high impedance. The default output impedance is 50Ω. The output impedances are to be used as a reference only. If the actual load impedance is different to that specified, then the actual amplitude and offset will vary accordingly.

Note The following describes how to set the output impedance on the AFG-3022 and 3032. To set the output impedance on the AFG-3021/3031, please see page 174.

Panel Operation 1. Press the CH1 or CH2 key. 



- 2. Press F1 (Load).  

- 3. Select F1 (50 OHM) or F2 (High Z) to select the output impedance for the selected channel.    



DSO Link



Background DSO Link enables the AFG-3022 or AFG-3032 to receive lossless data from a GDS-2000 Series DSO to create ARB data for the selected channel.

Note All models support the DSO Link function. However the menu tree operation varies between the single and dual channel models. The procedure here is only applicable to the AFG-3022 and AFG-3032. For the AFG-3021/3031, please see page 175.

- Panel Operation**
- 1. Connect the AFG-3022/AFG-3032 USB host port to the GDS-2000's USB B device port.  

 - 2. Press the CH1 or CH2 key. 

 - 3. Press F6 (DSOLink).  

 - 4. Press F1 (Search).  

5. To select the DSO channel, press F1 (CH1), F3 (CH2), F4 (CH3) or F5 (CH4). The acquired data can then be displayed.



6. After a few moments the AFG-30XX will automatically switch over to the ARB function and the waveform that was saved from the DSO will be plotted as an ARB waveform.

See the ARB chapter to edit or save the resultant waveform.

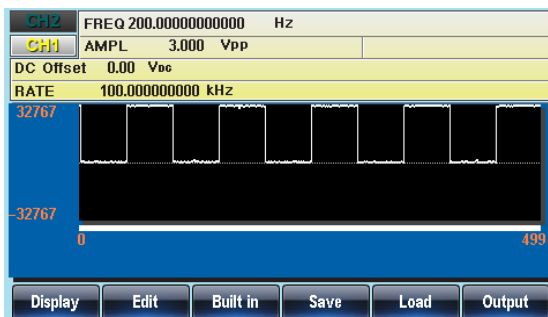

Frequency Coupling

Background Frequency coupling sets the frequency of the unselected channel as a frequency offset from the selected channel or as a ratio of the frequency of the selected channel.



1. Press the UTIL key.



2. Press F5 (Dual Ch).



3. Press F1 (Freq Cpl).  

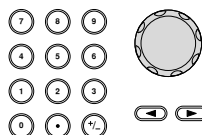

4. To set the unselected channel's frequency as an offset from the selected channel's frequency, press F2 (Offset).  

Use the selector keys and scroll wheel or number pad to enter the frequency offset.





Press F2~F6 to select the offset frequency units.



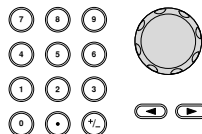

5. To set the unselected channel's frequency as a ratio of the selected channel's frequency, press F3 (Ratio).  

Use the selector keys and scroll wheel or number pad to enter the ratio.



Press F5 (Enter) to confirm.  

6. Alternatively, press F1 (OFF) to disable frequency coupling.  





Range	Offset Range	-30MHz ~ 30MHz (-20MHz ~ 20MHz)
	Offset Resolution	1uHz. Unselected channel's frequency = selected channel's frequency + offset. Selected channel's frequency is fixed.
	Ratio Range	1000.000 ~ 0.001
	Ratio Resolution	0.001. Ratio = Unselected channel's frequency/selected channel's frequency. Selected channel's frequency is fixed.



Amplitude Coupling





Background Amplitude coupling couples the amplitude of one channel to the other channel. When the amplitude settings for one channel are changed, those same settings are automatically reflected in the other channel.

Panel Operation 1. Press the UTIL key.



2. Press F5 (Dual Ch).  

3. Press F2 (Ampl Cpl).  

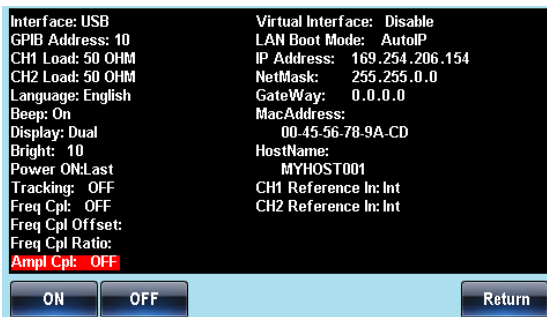

4. Press F1 to turn amplitude coupling ON or F2 to turn amplitude coupling OFF.  ~ 
 





Channel Tracking

Background Channel tracking will set the waveform output of one channel to be the same as the other channel. When the settings of one channel are changed, those changes are tracked on the other channel. This function also has the ability to perform inverted tracking, where the output on one channel is inverted in relation to the other channel.

- Panel Operation**
1. Press the UTIL key. 

 2. Press F5 (Dual Ch).  

 3. Press F3 (Tracking).  

4. To select the tracking function, press F1 (OFF), F2 (ON) or F3 (Inverted).



Multi-Unit Syncing

Multiple units can be synchronized to the same clock. The clock source can be an external reference or the internal reference output from the master AFG-30XX.

Multi Unit Connection

Background

There are two different connection methods that can be used to perform multi-unit syncing, however the method chosen determines the number of units that can be synced and the propagation time of the sync clock. The two connection methods are detailed below:

Daisy Chain Connection

When using the daisy-chain method, up to 4 units can be synced together. A BNC cable is connected from the master REF OUT port to the REF IN port of slave #1. The REF OUT port of slave #1 is connected to the REF IN port of slave #2 and so on up to slave #3.

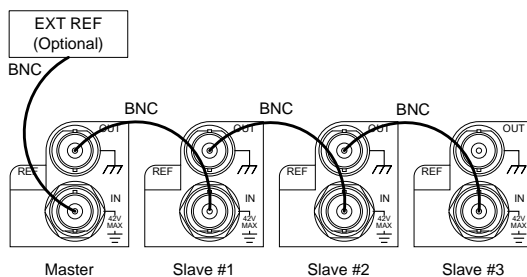

Note: The maximum phase delay for connected units that are daisy chained is defined by the following function:

$$\text{Max. phase delay(ns)} = 39 + (N-2) * 39 \pm 25\text{nS}$$

Where N is the number of connected units (total), for a maximum of 4.

Parallel Connection

When using the parallel connection method, a BNC cable is connected from the master REF OUT port to a T-divider. The T-divider then connects to the REF IN port of the slave #1 and to the second T-divider with BNC cables. This continues up to the second-last slave unit. The last slave unit terminates with a 50Ω terminator at the REF IN port. Up to 6 units in total can be connected together using the parallel connection method.

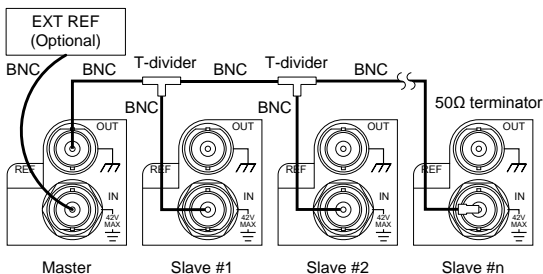

Note: The maximum phase delay of connected units that are connected in parallel is defined by the following function:

$$\text{Max. phase delay(ns)} = (N-1)*6 \pm 25\text{nS}$$

Where N is the number of connected units (total), for a maximum of 6.



Note

If the master unit is to use an external reference, connect the external reference signal to the rear panel REF IN port.

10MHz Reference Input Specifications:

Input Voltage	0.5Vp-p to 5Vp-p
Input Impedance	1kΩ, unbalanced, AC coupled
Max. Allowed Input	± 10Vdc
Input Frequency	10MHz ±10Hz
Waveform	sine or square (50± 5% duty) 10MHz, amplitude 0.5Vpp~5Vpp

Multi Unit Setup

Background The following will describe what configuration is required for the master and each connected slave unit for multi-unit control. See page 172 details.



Note

When using the external reference function, the ARB and dual channel function is not supported. Please see the reference clock sources chapter on page 172 for more details.

Panel Operation

1. Press the UTIL key.



2. Press F4 (System).



3. Press F3 (Clk Source).



4. To configure the master unit:

Press F1 (INT) for a master unit with an internal source signal.



Press F2 (EXT) for a master unit with an external source.



Press F3 (EXT Sync) to start syncing a master unit with the external source.



5. To configure the slave units:

Press F2 (EXT) for each slave unit*. The slave units accept the reference signal from the master unit.



Press F3 (EXT Sync) for each slave connected to the master unit.



*Return to Independent Operation

6. To return a slave unit back to independent operation, set Clk Source to F1 (INT).

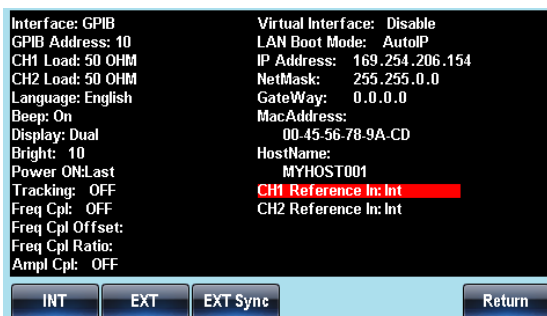

ARBITRARY WAVEFORMS

The AFG-30XX can create user-defined arbitrary waveforms. Each waveform can include up to 8M data points. Each data point has a vertical range of 65535 (± 32767) with a sample rate of 250MSa/s.

Inserting Built-In Waveforms	191
Inserting a Built-in Waveform.....	191
Inserting a DC Waveform	193
Inserting a Pulse Waveform.....	195
Display an Arbitrary Waveform	198
Set the Horizontal Display Range.....	198
Set the Vertical Display Properties	200
Page Navigation (Next Page)	202
Page Navigation (Back Page)	203
Overview Display	204
Editing an Arbitrary Waveform	205
Adding a point to an Arbitrary Waveform	205
Adding a line to an Arbitrary Waveform	206
Copy a Waveform.....	208
Clear the Waveform	209
ARB Protection.....	211
Output an Arbitrary Waveform	214
Output Length of an Arbitrary Waveform.....	214
Gated Output of the Arbitrary Waveform.....	215
Output an N Cycle Arbitrary Waveform	217
Output Arbitrary Waveforms – Infinite Cycles	219
Saving/Loading an Arbitrary Waveform	221
Saving a Waveform to Internal Memory.....	221
Saving a Waveform to USB Memory	222
Load a Waveform from Internal Memory.....	225
Load a Waveform from USB.....	227

Inserting Built-In Waveforms

The AFG-30XX function generators contain a number of functions to create a number of common waveforms including sine, square, ramp, $\sin(x)/x$, exponential rise, exponential fall, pulse and DC waveforms. There are a total of 65 built-in waveforms to choose from. See page 414 for a graphical representation of each waveform.

Inserting a Built-in Waveform

The following operating procedure can be used to insert any of the built-in ARB waveforms except for the DC & pulse waveforms. See page 193 & 195 to insert a DC or pulse waveform, respectively.

Panel Operation 1. Press the ARB key.



2. Press F3 (Built in).



3. Press F1~F5 to select a subcategory of built-in waveforms and then select a built-in waveform.



Basic	Sine, Square, Ramp, $\sin(x)/x$, Exponential Rise, Exponential Fall, Pulse, DC
Common 1	Absatan, Havers cosine, Sinever, Abs sin, Haversine, Stair_down, Abs sine half, N_pulse, Stair_UD, Ampalt, Negramp, Stair_up
Common 2	Attalt, Rectpuls1, Stepresp, Diric_even, Roundhalf, Trapezia, Diric_odd, Sawtoot, Tripuls1, Gauspuls1, Sinetra
Math	Dlorentz, ln, Sqrt, Since, Lorentz, Xsquare, Gauss, Since

Trigonometric	Arccos, Arctan, Sech, Arccot, Arctanh, Sinh, Arccsc, Cosh, Tan, Arcsec, Cot, Tanh, Arcsin, Csc, Arcsinh, Sec
Window	Barthannwin, Chebwin, Kaiser, Bartlett, Flattopwin, Triang, Blackman, Hamming, Tukeywin, Bohmanwin, Hann

4. The selected built-in waveform will be shown in red on the display. The remainder of the ARB waveform will be shown in green.

5. Press F1(Start).



6. The Start property will become highlighted in red.

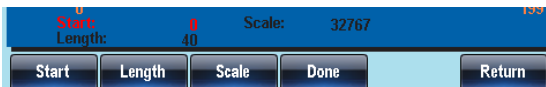

7. Use the selector keys and scroll wheel or number pad to enter the Start address of the waveform.

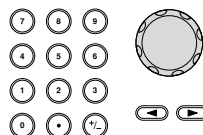

8. Press F5 (Enter) to confirm the Start point.



9. Repeat steps 5~8 for Length (F2) and Scale (F3).



- Length denotes how many points the waveform is stretched in the x direction.
- Scale denotes the vertical scale of the waveform from the center line.

Range	Item	Setting Range
	Start	0 ~ 8388606
	Length	2 ~ 8388608
	Scale	1 ~ 32767

10. Press F4 (Done) to complete the operation.

11. Press F6 (Return) to return to the previous menus.

Below a sine wave created at start: 0, Length: 40, Scale: 32767

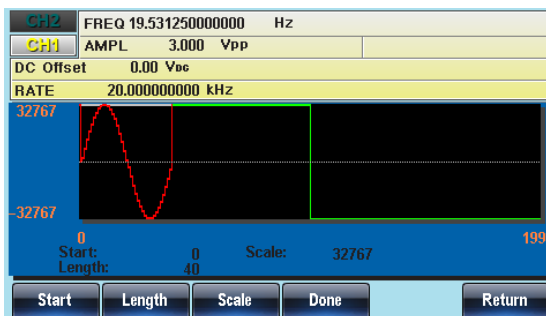

Inserting a DC Waveform

- Panel Operation
1. Press the ARB key.
 2. Press F3 (Built in).
 3. Press F1(Basic).
 4. Press F5 (More).



5. Press F3 (DC).  



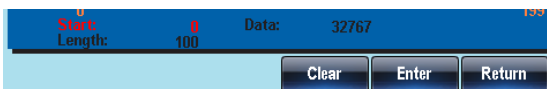

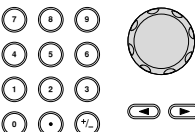
6. Press F1 (Start).  

7. The Start property will become highlighted in red.





8. Use the selector keys and scroll wheel or number pad to enter the Start address of the DC waveform. 



9. Press F5 (Enter) to confirm the Start point.  

10. Repeat steps 4~9 for Length (F2) and Data (F3).  
 

- Length denotes how many points the DC waveform is stretched in the x direction.
- Data denotes the vertical level of the DC waveform from the zero level.

Range	Item	Setting Range
	Start	0 ~ 8388606
	Length	2 ~ 8388608
	Data	-32767 ~ 32767

11. Press F5 (Done) to complete the operation.  

12. Press F6 (Return) to return to the previous menus.  

Below a DC waveform created at start:0, Length: 524288, Data: 10000.



Inserting a Pulse Waveform

The following operating procedure can be used to insert a pulse waveform into an ARB waveform.

Range	Frequency	Resolution	Duty Resolution
	1pHz~5Hz	1pHz	0.0001%
	>5Hz~50Hz	1uHz	0.0001%
	>50Hz~500Hz	10uHz	0.001%
	>500Hz~5kHz	100uHz	0.01%
	>5kHz~50kHz	1mHz	0.1%
	>50kHz~500kHz	10mHz	1%

Panel Operation 1. Press the ARB key.



2. Press F3 (Built in).



3. Press F1(Basic).



4. Press F5 (More).



5. Press F4 (Pulse).



6. Press F1 (Frequency).



7. The Pulse Freq property will become highlighted in red.

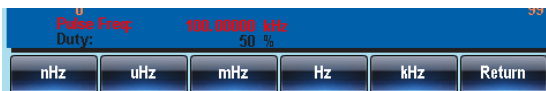

8. Use the selector keys and scroll wheel or number pad to enter the pulse frequency.

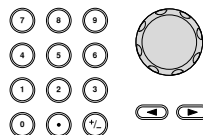

9. Press F1~F5 to select the frequency unit.



10. Press F2 (DUTY) and use the number pad or scroll wheel to choose the duty.

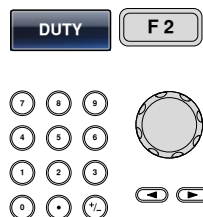

11. Press F5 (%) to complete the operation.



12. Press F5 (Done) to complete the operation.



13. Press F6 (Return) to return to the previous menus.



Below a Pulse waveform created with a frequency of 100kHz and a duty cycle of 50%.

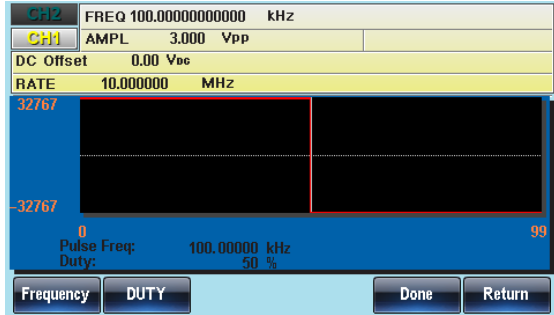

Display an Arbitrary Waveform

Set the Horizontal Display Range

The horizontal window bounds can be set in one of two ways: Using a start point and length, or a center point and length.

Panel Operation 1. Press the ARB key.



2. Press F1 (Display) to enter the display menu.



3. Press F1 (Horizon) to enter the horizontal menu.



Setting the Window Bounds

The Length setting will determine the width of the display window. The Horizontal Start parameter will set the starting position of the display window. The Center parameter can be used to set the center point of the window.

4. Press (F2) Length.





5. The Length parameter will become highlighted.



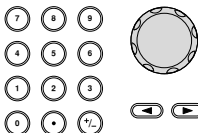



6. Use the selector keys and scroll wheel or number pad to enter the Length value.





- F4 (clear) can be used to undo a value.

7. Press F5 (Enter) to save the setting.  



Setting the Start point or Center Point

8. Repeat steps 4~8 for either Start (F1) or Center F3.  ~ 
 
- The Start soft-key is used to edit the Horizontal From parameter.

Zoom in

9. To zoom into the arbitrary waveform, press F4 (Zoom In). The Zoom In function will reduce the length by half each time the function is used. The minimum allowable length is 3.  

Zoom out

10. To zoom out from the center point of the waveform, press F5 (Zoom out). The Zoom out function will increase the length by 2. The maximum allowable length is 8388608.  

Below, an arbitrary sine waveform has a start of 0, length of 40 and is centered at 20.

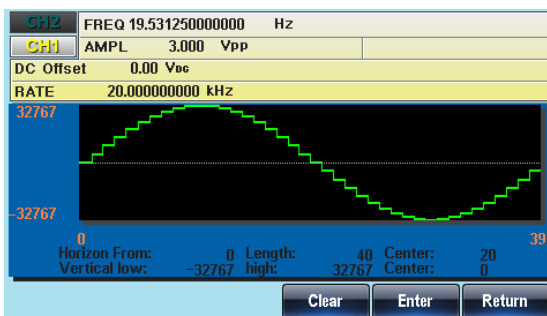

Set the Vertical Display Properties

Like the horizontal properties, the vertical display properties of the waveform display can be created in two ways: Setting high and low values, or setting the center point.

Panel Operation 1. Press the ARB key.



2. Press F1 (Display).



3. Press F2 (Vertical).



Setting the Low & High Point 4. Press F1 (Low).



5. The Vertical Low parameter will become highlighted.



6. Use the selector keys and scroll wheel or number pad to enter the Vertical Low value.

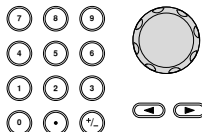

- F4 (clear) can be used to undo a value.

7. Press F5 (Enter) to save settings.



Setting the High Point 8. Repeat steps 4~8 for High (F2).



Setting the Center Point 9. Repeat steps 4~8 for Center (F3), if required.



Zoom

10. To vertically zoom in from the center of the arbitrary waveform, press F4 (Zoom In). The Zoom In function will reduce the amplitude by half each time the function is used. The minimum allowable vertical low is -2, and the minimum vertical high is 2.



11. To vertically zoom out of the waveform, press F5 (Zoom out). The Zoom out function will increase the amplitude by 2. The Vertical low maximum can be set to -32767 and the vertical high maximum can be set to +32767.



Below, the sine wave is with a vertical low of -16384, a vertical high 16384 and a center of 0. Note how the sine wave is clipped due to the vertical display bounds.



Page Navigation (Next Page)

Background When viewing the waveform, the display window can be moved forward and backward using the Next/Back Page functions.

Panel Operation 1. Press the ARB key.



2. Press F1 (Display).



3. Press F3 (Next Page) to move the display window one view length forward.



New Horizon From*=Horizon From + Length

New Center=Center + Length

*Horizon From +Length ≤ 8388608

Below, shows the display after Next Page has been pressed.

Horizon From: 0 → 45



Length: 45

Center:22→ 67



Page Navigation (Back Page)

Background When viewing the waveform, the display window can be moved forward and backward using the Next/Back Page functions.

- Panel Operation**
1. Press the ARB key. 
 2. Press F1 (Display). 
 3. Press F4 (Back Page) to move the display window one view length backward. 

$$\text{New Horizon From}^* = \text{Horizon From} - \text{Length}$$

$$\text{New Center}^* = \text{Center} - \text{Length}$$

*Length until 0

Below, shows the display after Back Page has been pressed.

Horizon From: 45 → 0

Length: 45

Center: 67 → 22

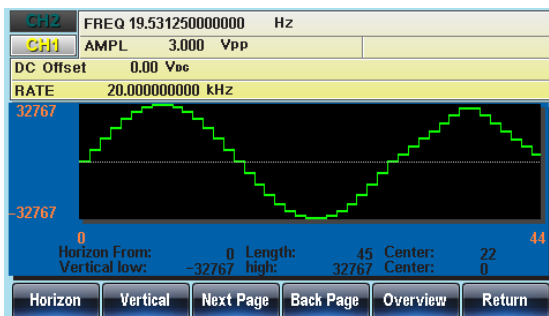

Overview Display

Panel Operation 1. Press the ARB key.



2. Press F1 (Display).



3. To make the display window cover the whole waveform, press F5 (Overview).



Horizontal: 0~8388607,
Vertical: 32767~ -328767

Below shows the display after Overview has been selected.

Horizon From: 0

Length: 8388608

Center: 4194304



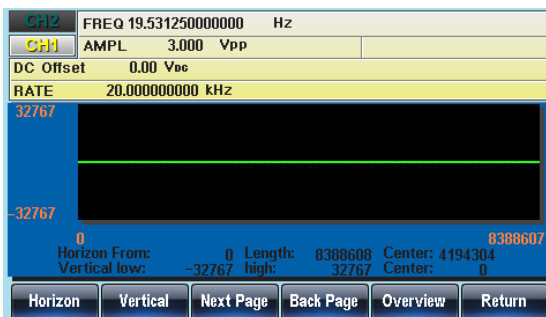

Vertical low/high: ± 32767





Editing an Arbitrary Waveform

Adding a point to an Arbitrary Waveform

Background The AFG-30XX has a powerful editing function that allows you to create points or lines anywhere on the waveform.

- Panel Operation**
1. Press the ARB key. 
 2. Press F2 (Edit). 
 3. Press F1 (Point). 
 4. Press F1 (Address). 
 5. The Address parameter will become highlighted in red.

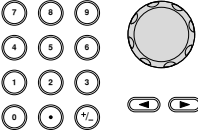

6. Use the selector keys and scroll wheel or number pad to enter the Address value. 
7. Press F5 (Enter) to save settings. 
8. Press F2 (Data). 

9. The Data parameter will become highlighted in red.

10. Use the selector keys and scroll wheel or number pad to enter a Data value.

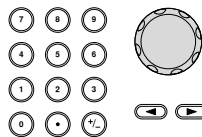

11. Press F5 (Enter) to save settings.



12. Press F6 (Return) to return to the ARB menu.



Below shows Address set to 8 and Data set to 0. The edited area is shown in red.

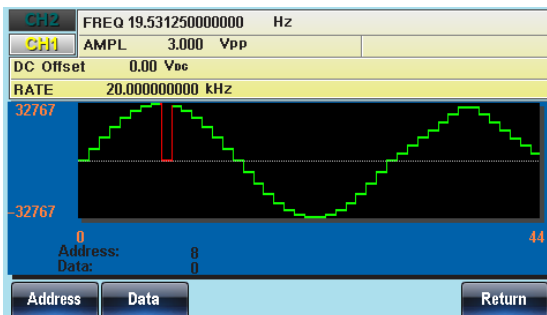

Adding a line to an Arbitrary Waveform

Background The AFG-30XX has a powerful editing function that allows you to create points or lines anywhere on the waveform.

Panel Operation 1. Press the ARB key.



2. Press F2 (Edit).



3. Press F2 (Line).



4. Press F1 (Start ADD).



5. The Start Address parameter will become highlighted in red.

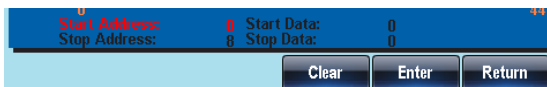

6. Use the selector keys and scroll wheel or number pad to enter the start address.

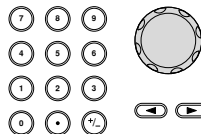

7. Press F5 (Enter) to save settings.



8. Repeat steps 4~7 for Start Data (F2), Stop Address (F3) and Stop Data (F4)

9. Press F5 (Done) to confirm the line edit.



10. Press F6 (Return) to return to the previous menus.



A red line was created below with the following properties:

Start Address: 8, Start Data: 0

Stop Address: 15, Stop Data: 0

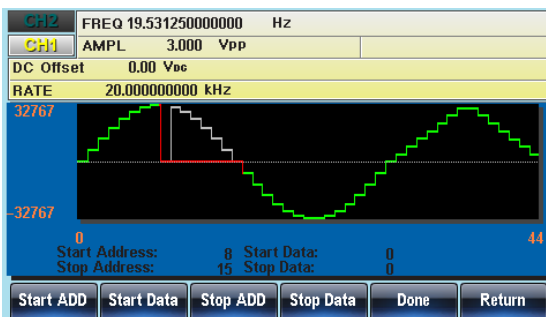

Copy a Waveform

Panel Operation 1. Press the ARB key.



2. Press F2 (Edit).



3. Press F3 (Copy).



4. Press F1 (Start).



5. The Copy From properties will become highlighted in red.

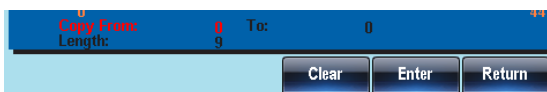

6. Use the selector keys and scroll wheel or number pad to enter the Copy From address.

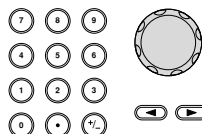

7. Press F5 (Enter) to save settings.



8. Repeat steps 4~7 for Length (F2) and Paste To (F3).

9. Press F5 (Done) to confirm the selection.



10. Press F6 (Return) to return to the previous menus.



A section of the waveform from points 30~45 was copied to points 0~15:

Copy From: 30

Length: 15

To: 0

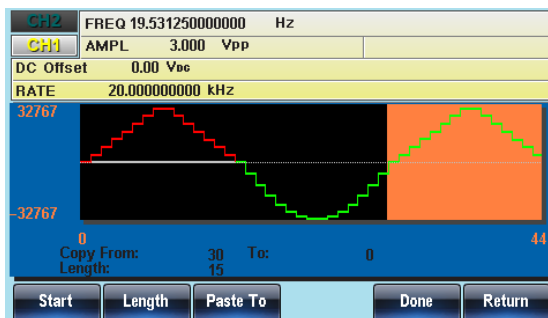

Clear the Waveform

Panel Operation 1. Press the ARB key.



2. Press F2 (Edit).



3. Press F4 (Clear).



4. Press F1 (Start).



- The Clear From property will become highlighted in red.



- Use the selector keys and scroll wheel or number pad to enter the Clear From address.

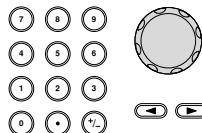

- Press F5 (Enter) to save settings.



- Repeat steps 4~8 for Length (F2).



- Press F3 (Done) to clear the section of the arbitrary waveform.



- Press F6 (Return) to return to the previous menus.



Delete All

- Press F5 (ALL) to delete the whole waveform.



- Press F5 (Done) again to confirm the deletion.



- Press F6 (Return) to return to the previous menus.



Clear From: 0, Length: 15.

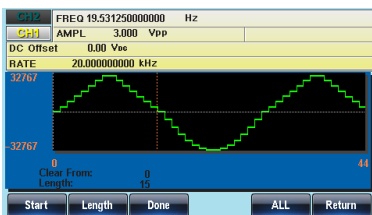

The same area after being cleared.



The result after the whole waveform is deleted.

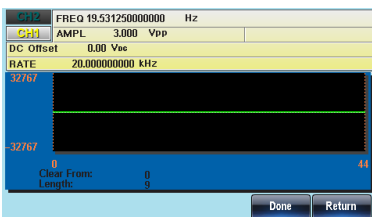

ARB Protection

The protection function designates an area of the arbitrary waveform that cannot be altered.

Panel Operation 1. Press the ARB key.



2. Press F2 (Edit).



3. Press F5 (Protect).



4. Press F2 (Start).



5. The Protect Start property will become highlighted in red.

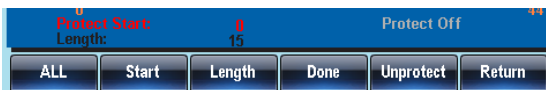

6. Use the selector keys and scroll wheel or number pad to enter the Protect Start address.

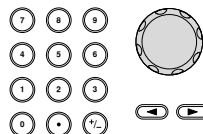

7. Press F5 (Enter) to save settings.



8. Repeat steps 4~8 for Length (F3).



9. Press F5 (Done) to confirm the protected area.



10. The protected area will be shown in orange.

Protect All

11. Press F1 (ALL) to protect the whole waveform.



12. Press F6 (Done) to confirm.



Unprotect All

13. Press F5 (Unprotect) to release the protect function for the whole waveform.



14. Press F6 (Done) to confirm.



15. The waveform background will return back to black. The property "Protect Off" will be shown in gray.

Below, the protected areas of the waveform are shown with an orange background:

Protect Start: 0, Length: 15.

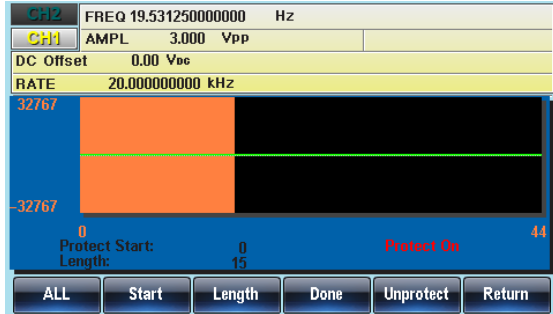

Output an Arbitrary Waveform

Up to 8Mpts (0~8388607) of an arbitrary waveform can be output from the function generator. Arbitrary waveforms can also be output for a defined or infinite amount of cycles.

Output Length of an Arbitrary Waveform

Panel Operation 1. Press the ARB key.



2. Press F6 (Output).



3. Press F1 (Start).



4. The Start property will become highlighted in red.



5. Use the selector keys and scroll wheel or number pad to enter the Start address.

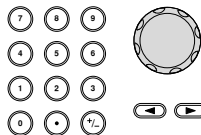

6. Press F5 (Enter) to confirm the Start point.



7. Repeat steps 4~7 for Length (F2).



Below the waveform from position 0 with a length of 1024 is output from the front panel terminal.

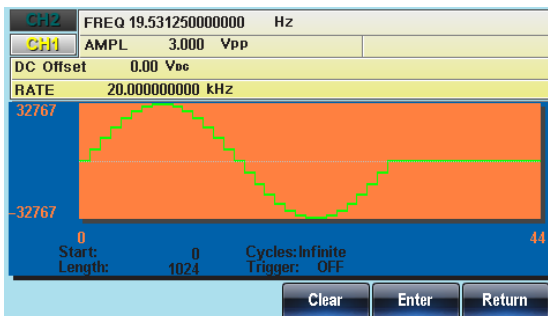

Gated Output of the Arbitrary Waveform

Background The ARB waveform output can be output using the rear panel trigger input when the trigger is set to Gate. The Gate trigger can be configured to output the arbitrary waveform on a positive or negative trigger level.

Panel Operation 1. Press the ARB key.



2. Press F6 (Output).



3. Define the Start and Length of the arbitrary waveform output. [Page 214.](#)

Note: Changing the length will change the duty/frequency of pulse waveforms.

4. Press F3 (Gate).



5. Choose Positive or Negative to select the trigger polarity.

 - When a Gate mode is selected any previous trigger output setting is disabled.
 - The Gated mode can be turned off by selecting a different output mode, such as Ncycle or Infinite.

GATE Triggering 6. The ARB waveform will be output on either a high or low TTL level input from the TRIG input terminal on the rear panel, for the selected channel.

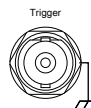

Note: Ensure the output key has already been pressed and the OUTPUT light is lit *before* inputting a signal into the trigger input terminal.

7. Press F6 (Return) to return to the previous menu.

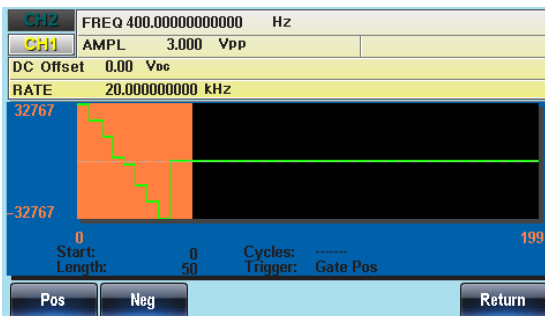

Below shows the trigger set to Gate Pos.







Output an N Cycle Arbitrary Waveform

Background The output of an arbitrary waveform can be repeated for a designated number of cycles. The N Cycle function uses manual triggering or external triggering. Manual triggering will trigger each time.

Range 1 to 8388607 cycles

- Panel Operation**
1. Press the ARB key. 
 2. Press F6 (Output).  
 3. Define the Start and Length of the arbitrary waveform output. [Page 214.](#)

Note: Changing the length will change the duty/frequency of pulse waveforms.

4. Press F4 (N Cycle).  
5. Press F1 (Cycles).  
6. The Cycles property will become highlighted in red.

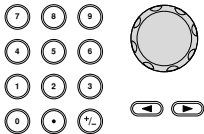

7. Use the selector keys and scroll wheel or number pad to enter the number of cycles.
- 

8. Press F5 (Enter) to confirm the number of cycles.
- 

Manual Triggering

9. Press Manual (F4) to set the unit to manual triggering.
- 

10. Press Trigger (F5) to internally trigger the output once.
- 

Note: Ensure the output key has already been pressed and the OUTPUT light is lit *before* pressing F5 (Trigger).

11. Press F6 (Return) to return to the previous menu.
- 

External Triggering

12. Press EXT (F3) to trigger using the external signal input from the TRIG input terminal on the rear panel.
- 

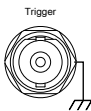
13. The N-cycle waveform will be output on a rising edge of a TTL high level pulse input from the TRIG input terminal on the rear panel, for the selected channel.
- TRIG Input
- 

Note: Ensure the output key has already been pressed and the OUTPUT light is lit *before* inputting a signal into the trigger input terminal.

14. Press F6 (Return) to return to the previous menu.



Below a waveform of 3 cycles is output from the front panel terminal.

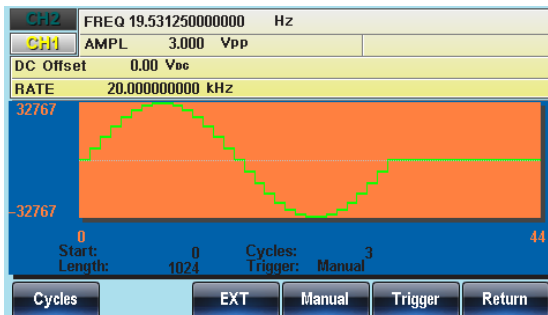

Output Arbitrary Waveforms – Infinite Cycles

Background The output of an arbitrary waveform can be repeated an infinite amount of times to create a cyclic waveform.

Panel Operation 1. Press the ARB key.



2. Press F6 (Output).



3. Define the Start and Length of the arbitrary waveform output. Page 214.

Note: Changing the length will change the duty/frequency of pulse waveforms.

4. Press F5 (Infinite) to output the arbitrary waveform infinitely.



Note: The ARB waveform will be output when the Output key is pressed.

5. Press F6 (Return) to return to the previous menus.





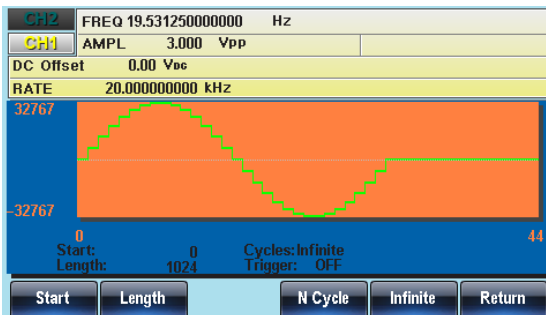



Below an infinite cycle waveform is output from the front panel terminal.



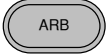

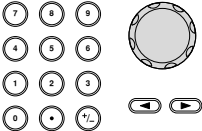

Saving/Loading an Arbitrary Waveform

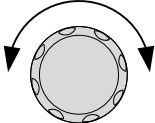
The AFG-30XX Series contain a number of functions to create a number of common waveforms including sine, square, ramp, sinc, exponential rise, exponential fall and DC waveforms.

Saving a Waveform to Internal Memory

- Panel Operation
1. Press the ARB key. 
 2. Press F4 (Save). 
 3. Press F1 (Start). 
 4. The Start property will become highlighted in red.
 5. Use the selector keys and scroll wheel or number pad to enter the Start address. 
 6. Press F5 (Enter) to confirm the Start point. 
 7. Repeat steps 4~6 for Length (F2). 
 8. Press F3 (Memory). 
 9. Select a memory file using the scroll wheel. 
ARB0~ARB9

10. Press F1 (Select) to save the waveform to the selected file.  

11. Press F6 (Return) to return to the previous menus.  

Below the file ARB1 is selected using the scroll wheel.

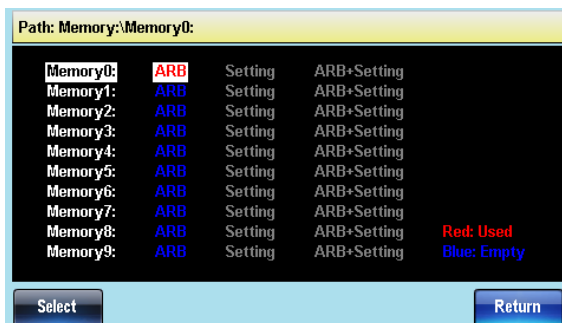

Saving a Waveform to USB Memory

Panel Operation 1. Press the ARB key.



2. Press F4 (Save).  



3. Press F1 (Start).  

4. The Start property will become highlighted in red.

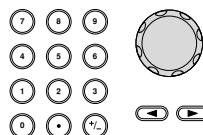
5. Use the selector keys and scroll wheel or number pad to enter the Start address.





6. Press F5 (Enter) to confirm the Start point.  

7. Repeat steps 4~6 for Length (F2).  

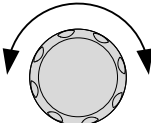
8. Press F4 (USB).  

9. Use the scroll wheel to navigate the filesystem. 

10. Press Select to select directories or file names.  

Create a Folder 11. Press F2 (New Folder).  

12. The text editor will appear with a default folder name of "NEW_FOL".

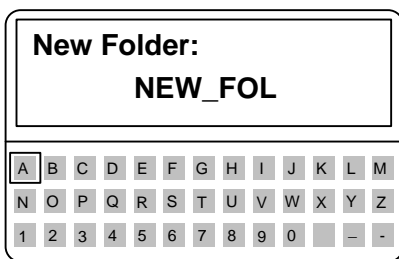

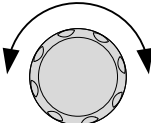
13. Use the scroll wheel to move the cursor. 

14. Use F1 (Enter Char) or F2 (Backspace) to create a folder name.



15. Press F5 (Save) to save the folder name.



Create New File 16. Press F3 (New File).



17. The text editor will appear with a default file name of "NEW_FIL".

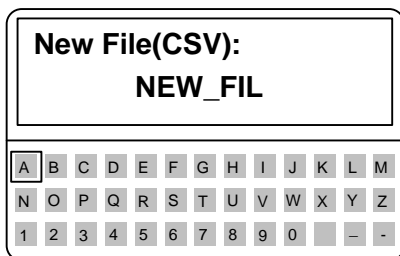

18. Use the scroll wheel to move the cursor.

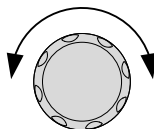

19. Use F1 (Enter Char) or F2 (Backspace) to create a file name.



20. Press F5 (Save) to save the file name.



Below, the folder “ABC” and the file “AFG.CSV” have been created in the root directory.

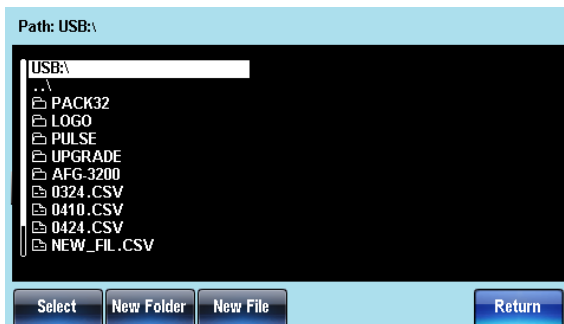

Load a Waveform from Internal Memory

Panel Operation 1. Press the ARB key.



2. Press F5 (Load).



3. Press F1 (To) to choose the starting point to load the waveform from.



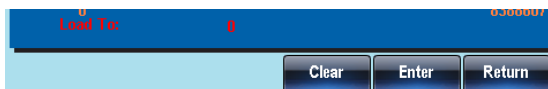

- Set to 0 by default

4. The “Load To” property will become highlighted in red.



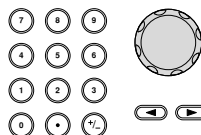

5. Use the selector keys and scroll wheel or number pad to enter the starting point.

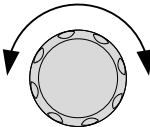

6. Press F5 (Enter) to confirm the Start point.  

7. Press F3 (Memory).  

8. Use the scroll wheel to navigate the filesystem. 

9. Press Select to select directories or file names.  

The ARB waveform will be loaded immediately.

Below the file ARB1 is selected using the scroll wheel loaded to position 0.

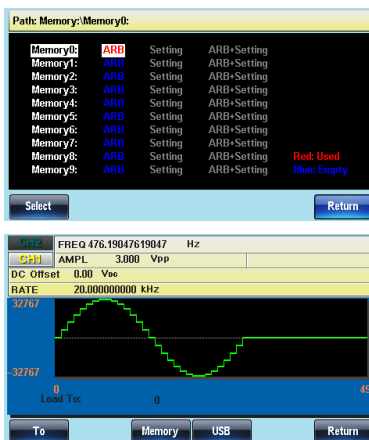

Load a Waveform from USB

Panel Operation 1. Press the ARB key.



2. Press F5 (Load).



3. Press F1 (To) to choose the starting point to load the waveform from.



- Set to 0 by default

4. The “Load To” property will become highlighted in red.

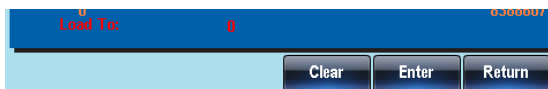

5. Use the selector keys and scroll wheel or number pad to enter the starting point.

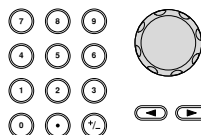

6. Press F5 (Enter) to confirm the Start point.



7. Press F4 (USB).



8. Use the scroll wheel to choose a file name.

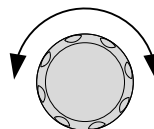

9. Press F1 (Select) to select the file to load.



The ARB waveform will be loaded immediately.

Below the file AFG.CSV is selected using the scroll wheel loaded to position 0.

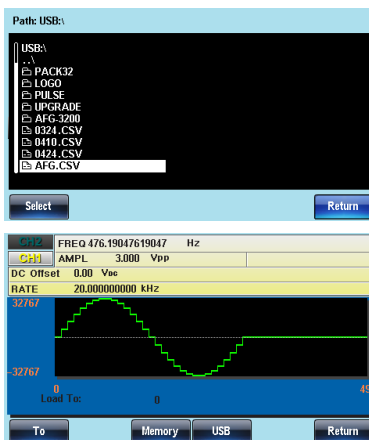

REMOTE INTERFACE

Establishing a Remote Connection	230
Web Browser Control Interface	237
Command Syntax.....	240
Command List.....	245
488.2 Common Commands	251
Status Register Commands	254
System Commands.....	260
Apply Commands	263
Output Commands.....	271
Pulse Configuration Commands	281
Harmonic Commands	284
Amplitude Modulation (AM) Commands.....	288
AM Overview.....	288
Frequency Modulation (FM) Commands	293
FM Overview	293
Frequency-Shift Keying (FSK) Commands	298
FSK Overview	298
Phase Modulation (PM) Commands.....	302
PM Overview	302
Additive Modulation (SUM) Commands.....	306
SUM Overview.....	306
Pulse Width Modulation (PWM) Commands	311
PWM Overview	311
Frequency Sweep Commands	316
Sweep Overview	316
Burst Mode Commands.....	327
Burst Mode Overview	327

Arbitrary Waveform Commands 337
 Arbitrary Waveform Overview 337
 Tracking Commands 378
 Reference Commands 383
 Save and Recall Commands 384
 Error Messages 386
 SCPI Status Registers 399

Establishing a Remote Connection

The AFG-3021, AFG-3022, AFG3031 and AFG-3032 support USB, LAN and GPIB remote connections.

Configure USB interface

USB configuration	PC side connector	Type A, host
	AFG-30XX side connector	Type B, slave
	Speed	1.1/2.0 (full speed)

- Panel Operation
1. Download and install the USB driver from the GW Instek website, www.gwinstek.com. Go to the Product > Signal Sources > Arbitrary Function Generators > AFG-30XX product page to find the USB driver setup file.

Double click the driver file and follow the instructions in the setup wizard to install the driver.

2. Press the Utility key followed by Interface (F2) and USB (F2).



3. Connect the USB cable to the rear panel USB B (slave) port.



Configure GPIB interface

GPIB configuration	Connector	24 pin Female
	GPIB address	1-30

- GPIB constraints
- Maximum 15 devices altogether, 20m cable length, 2m between each device
 - Unique address assigned to each device
 - At least 2/3 of the devices turned On
 - No loop or parallel connection

Pin assignment

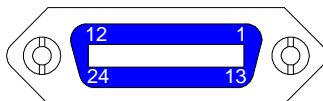

Pin1	Data line 1	Pin13	Data line 5
Pin2	Data line 2	Pin14	Data line 6
Pin3	Data line 3	Pin15	Data line 7
Pin4	Data line 4	Pin16	Data line 8
Pin5	EOI	Pin17	REN
Pin6	DAV	Pin18	Ground
Pin7	NRFD	Pin19	Ground
Pin8	NDAC	Pin20	Ground
Pin9	IFC	Pin21	Ground
Pin10	SRQ	Pin22	Ground
Pin11	ATN	Pin23	Ground
Pin12	Shield (screen)	Pin24	Signal ground

Panel Operation 1. Connect the GPIB cable to the rear panel GPIB port.

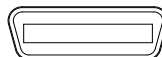

2. Press the Utility key followed by Interface (F2) and GPIB(F1). Press Address (F1).



- Use the scroll wheel or number pad to choose an address.

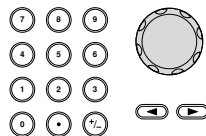

- Press Done (F5) to confirm.



Configure LAN interface

LAN configuration	MAC Address	Domain Name
	Instrument Name	DNS IP Address
	User Password	Gateway IP Address
	Instrument IP Address	Subnet Mask
	HTTP Port 80 (fixed)	

- Connect the LAN cable to the rear panel LAN port.



- Press the Utility key followed by Interface (F2) and LAN (F3).



DHCP Connections Use DHCP to automatically configure the IP address of the unit for networks with a DHCP server.

- Press Config (F2) followed by DHCP (F1), Done(F5). Press Done(F5) again.



**Auto IP
Connections**

Use Auto IP to automatically configure the IP address of the unit when it is directly connected to a host PC via the Ethernet cable.

4. Press Config (F2) followed by Auto IP (F2), Done(F5). Press Done(F5) again.



**Manual IP
Connections**

Manually configure the IP address.

5. Press Config (F2) followed by Manual (F3).



6. Press IP Addr (F1) and set the IP address using the number pad. Press Done (F1) to complete setting the IP Address.



7. Press NetMask (F2) and set the mask address using the number pad. Press Done (F1) to complete setting the net mask.



8. Press Gateway (F3) and set the gateway address using the number pad. Press Done (F1) to complete setting the gateway.



9. Press Done (F5) to complete setting the manual IP address and to return to LAN interface menu. Press Done(F5) again.



Setting the Host Name

10. Press Host Name (F4).



11. Enter the host name using the scroll wheel, arrow keys and soft-keys. Use the scroll wheel to highlight a character, and press Enter Char (F1) to select the highlighted character.

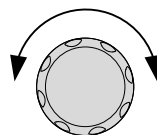

12. Press Done (F5) to finish setting the Host Name. Press Done(F5) again.



Remote control terminal connection example

AFG Setup

Configure the interface to USB (page 230) and connect the AFG to the PC.

Terminal application

Invoke the terminal application such as MTTY (Multi-Threaded TTY). Set the COM port in the application according to the COM port assigned to the AFG-30XX.

To check the COM port number, see the Device Manager in the PC. For WinXP go to Control panel → System → Hardware tab.

Functionality check

Run this query command via the terminal.

*idn?

This should return the Manufacturer, Model number, Serial number, and Firmware version in the following format.

GW INSTEK,AFG-3032,SN:XXXXXXXX,Vm.mm

Display

When a remote connection is established all panel keys are locked except for F6.

1. Press REM/LOCK (F6) to return the function generator to local mode.

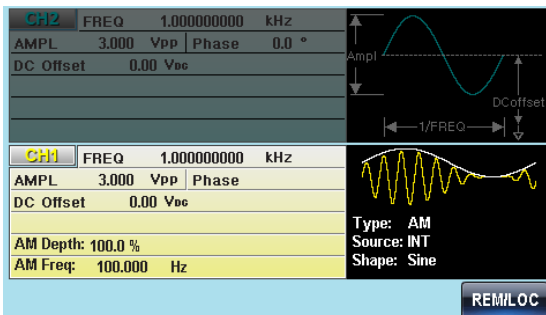

Web Browser Control Interface

The AFG-30XX also has a browser-based interface to remotely control the unit over a network.

Overview

Welcome Page

The Welcome Page is the home page for the browser control interface. This page lists instrument information and the LAN configuration. It also has links to the Browser Web Control and the View & Modify Configuration pages.

Support | Products | Generate QR

GW INSTEK
Made to Measure AFG3000 Arbitrary Function Generator

Welcome Page
Browser Web Control
View & Modify Configuration

Welcome to your

Web-Enabled AFG-3032 Arbitrary Function Generator

Information about this Web-Enabled Instrument

Instrument:	AFG-3032
Serial Number:	111111111
Description:	GW INSTEK AFG-3032 SN 111111111 V0.18D
Hostname:	MYHOST001
Config Type:	AutoIP
IP Address:	169.254.206.154
VISA TCP/IP Connect String:	TCP/IP: 169.254.206.154:1026: SOCKET
MAC Address:	00-45-56-78-9A-CD
Software Version:	GW INSTEK AFG-3032 DATE 0901 SOFT V0.180 FWQA3108 Boot V0.18 SN 111111111
Auto-MSIX Capable:	Yes

Use the navigation bar on the left to access your AFG-3032 Arbitrary Function Generator and related information.

© GW INSTEK Technologies, Inc. 2011

Browser Web Control

The Browser Web Control allows you to remotely control and view the unit over a LAN. The unit can be controlled via a virtual control panel using a mouse, with SCPI controls via an SCPI input box or by running SCPI commands in a file.

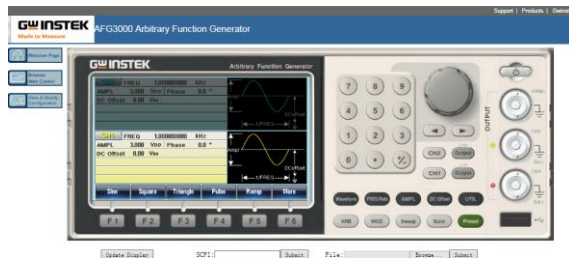

View & Modify Configuration

The View & Modify Configuration page displays all the LAN configuration settings and allows you to edit the configuration.

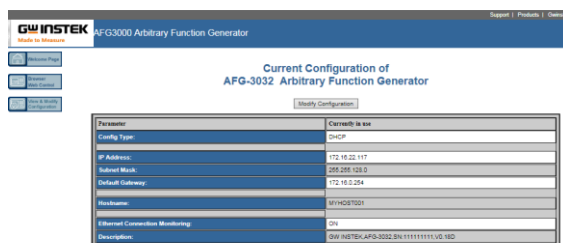

Operation

1. Configure the AFG-30XX interface to LAN and connect it to the LAN or directly to the PC (if the LAN interface is set to Auto IP).

See Page 233 for the LAN configuration details.

- Next enable the virtual interface on the AFG-30XX. Press the Utility key followed by Interface (F2), LAN (F3) and Remote (F1) to enable/disable the Virtual interface.

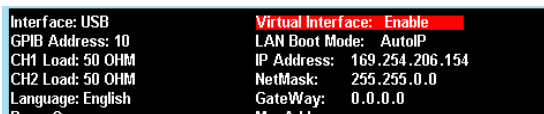

- Enter the IP address of the unit into the address bar of your web browser as follows:

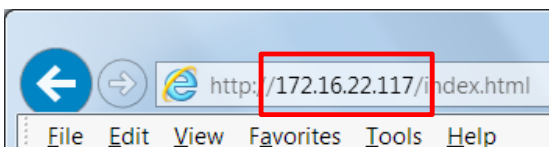

- The Welcome page will appear in the browser.



Command Syntax

- | | |
|---------------------|-------------------------------------------------------------------------------------------------------------------------------------|
| Compatible standard | <ul style="list-style-type: none"> • IEEE488.2, 1992 (fully compatible) • SCPI, 1994 (partially compatible) |
|---------------------|-------------------------------------------------------------------------------------------------------------------------------------|

Command Tree The SCPI standard is an ASCII based standard that defines the command syntax and structure for programmable instruments.

Commands are based on a hierarchical tree structure. Each command keyword is a node on the command tree with the first keyword as the root node. Each sub node is separated with a colon.

Shown below is a section of the SOURce[1 | 2] root node and the :PWM and :PULSe sub nodes.

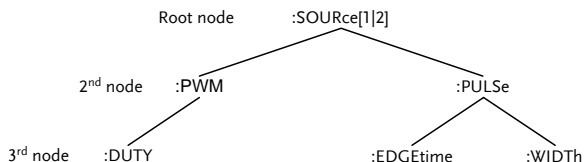

Command types Commands can be separated in to three distinct types, simple commands, compound commands and queries.

Simple	A single command with/without a parameter
Example	*OPC
Compound	Two or more commands separated by a colon (:) with/without a parameter
Example	SOURce1:PULSe:WIDTh

Query	A query is a simple or compound command followed by a question mark (?). A parameter (data) is returned. The maximum or minimum value for a parameter can also be queried where applicable.
Example	SOURce1:FREQuency? SOURce1:FREQuency? MIN

Command forms Commands and queries have two different forms, long and short. The command syntax is written with the short form of the command in capitals and the remainder (long form) in lower case.

long
long
 SOURce1:DCOffset
short
short

The commands can be written in capitals or lower-case, just so long as the short or long forms are complete. An incomplete command will not be recognized.

Below are examples of correctly written commands:

```
LONG  SOURce1:DCOffset
      SOURCE1:DCOFFSET
      source1:dcoffset
```

```
SHORT SOUR1:DCO
      sour1:dco
```

Command Format	$\text{SOURCE1:DCOffset} \underbrace{\langle \text{offset} \rangle}_{\text{LF}}$ <div style="display: flex; justify-content: center; gap: 10px; margin-top: -10px;"> 1 2 3 4 </div>	<p>1: command header</p> <p>2: single space</p> <p>3: parameter</p> <p>4: message terminator</p>
-------------------	-----------------------------------------------------------------------------------------------------------------------------------------------------------------------------------------------------------------------------------------	--------------------------------------------------------------------------------------------------

Square Brackets [] Commands that contain squares brackets indicate that the contents are optional. The function of the command is the same with or without the square bracketed items. Brackets are not sent with the command.

For example, the frequency query below can use any of the following 3 forms:

SOURCE1:FREQUENCY? [MINimum|MAXimum]

SOURCE1:FREQUENCY? MAXimum

SOURCE1:FREQUENCY? MINimum

SOURCE1:FREQUENCY?

Braces {} Commands that contain braces indicate one item within the braces must be chosen. Braces are not sent with the command.

Angled Brackets <> Angle brackets are used to indicate that a value must be specified for the parameter. See the parameter description below for details. Angled brackets are not sent with the command.

Bars | Bars are used to separate multiple parameter choices in the command format.

Parameters	Type	Description	Example
	<Boolean>	Boolean logic	0, 1/ON,OFF
	<NR1>	integers	0, 1, 2, 3
	<NR2>	decimal numbers	0.1, 3.14, 8.5
	<NR3>	floating point	4.5e-1, 8.25e+1
	<NRf>	any of NR1, 2, 3	1, 1.5, 4.5e-1

<NRf+> <Numeric>	NRf type with a suffix including MINimum, MAXimum or DEFault parameters.	1, 1.5, 4.5e-1 MAX, MIN,
<aard>	Arbitrary ASCII characters.	
<discrete>	Discrete ASCII character parameters	IMM, EXT, MAN
<frequency> <peak deviation in Hz> <rate in Hz>	NRf+ type including frequency unit suffixes.	1 KHZ, 1.0 HZ, MHZ
<amplitude>	NRf+ type including voltage peak to peak.	VPP
<offset>	NRf+ type including volt unit suffixes.	V
<seconds>	NRf+ type including time unit suffixes.	NS, S MS US
<percent> <depth in percent>	NRf type	N/A
Message terminators	LF CR	line feed code (new line) and carriage return.
	LF	line feed code (new line)
	EOI	IEEE-488 EOI (End-Or-Identify)
 Note	^j or ^m should be used when using a terminal program.	

Command Separators	Space	A space is used to separate a parameter from a keyword/command header.
	Colon (:)	A colon is used to separate keywords on each node.
	Semicolon (;)	A semi colon is used to separate subcommands that have the same node level. For example: SOURce[1]:DCOffset? SOURce[1]:OUTPut? →SOURce1:DCOffset?;OUTPut?
	Colon + Semicolon (;:)	A colon and semicolon can be used to combine commands from different node levels. For example: SOURce1:PWM:SOURce? SOURce:PULSe:WIDTh? →SOURce1:PWM:SOURce?::SOURce:PULSe:WIDTh?
Comma (,)	When a command uses multiple parameters, a comma is used to separate the parameters. For example: SOURce:APPLy:SQUare 10KHZ, 2.0 VPP, -1V	

Command List

488.2 Common Commands	251
*IDN?	251
*RST	251
*TST?	251
*OPC	252
*OPC?	252
*WAI	253
Status Register Commands	254
*CLS	254
*ESE	254
*ESR?	255
*STB?	255
*SRE	256
*PSC	257
STATus:QUEStionable:CONDition?	257
STATus:QUEStionable:EVENT?	258
STATus:QUEStionable:ENABLE	258
STATus:PRESet	259
System Commands	260
SYSTem:ERRor?	260
SYSTem:INTerface	260
SYSTem:LOCal	260
SYSTem:REMote	261
SYSTem:LANGuage	261
SYSTem:VERsion?	261
Apply Commands	263
SOURce[1 2]:APPLY:SINusoid	265
SOURce[1 2]:APPLY:SQUare	265
SOURce[1 2]:APPLY:RAMP	266
SOURce[1 2]:APPLY:PULSe	266
SOURce[1 2]:APPLY:NOISe	267
SOURce[1 2]:APPLY:TRIngle	268
SOURce[1 2]:APPLY:DC	268
SOURce[1 2]:APPLY:HARMonic	269
SOURce[1 2]:APPLY:USER	269
SOURce[1 2]:APPLY?	270
Output Commands	271
SOURce[1 2]:FREQuency	271
SOURce[1 2]:AMPLitude	272
SOURce[1 2]:PHASe	274
SOURce[1 2]:PHASe:ALIGn	274

SOURce[1 2]:DCOffset.....	274
SOURce[1 2]:SQUare:DCYCLE.....	275
SOURce[1 2]:RAMP:SYMMetry.....	276
OUTPut[1 2]	277
OUTPut[1]:LOAD	278
OUTPut[1 2]:SYNC.....	279
SOURce[1]:VOLTage:UNIT	280
Pulse Configuration Commands	281
SOURce[1 2]:PULSe:WIDTh.....	281
SOURce[1 2]:PULSe:DCYCLE.....	282
SOURce[1 2]:PULSe:EDGetime	282
SOURce[1 2]:PULSe:RISE	283
SOURce[1 2]:PULSe:FALL.....	284
Harmonic Commands.....	284
SOURce[1 2]:HARMonic:TOTAL	284
SOURce[1 2]:HARMonic:TYPE	285
SOURce[1 2]:HARMonic:ORDER	286
SOURce[1 2]:HARMonic:DISPlay	286
Amplitude Modulation (AM) Commands	288
AM Overview.....	288
SOURce[1 2]:AM:STATe.....	289
SOURce[1 2]:AM:MODulation:INPut.....	289
SOURce[1 2]:AM:INTernal:FUNcTION	290
SOURce[1 2]:AM:INTernal:FREQuency.....	291
SOURce[1 2]:AM:DEPTH.....	291
Frequency Modulation (FM) Commands.....	293
FM Overview	293
SOURce[1 2]:FM:STATe.....	294
SOURce[1 2]:FM:MODulation:INPut	294
SOURce[1 2]:FM:INTernal:FUNcTION	295
SOURce[1 2]:FM:INTernal:FREQuency	296
SOURce[1 2]:FM:DEVIation	296
Frequency-Shift Keying (FSK) Commands	298
FSK Overview	298
SOURce[1 2]:FSKey:STATe.....	298
SOURce[1 2]:FSKey:MODulation:INPut.....	299
SOURce[1 2]:FSKey:FREQuency	300
SOURce[1 2]:FSKey:INTernal:RATE	300
Phase Modulation (PM) Commands	302
PM Overview	302
SOURce[1 2]:PM:STATe.....	303
SOURce[1 2]:PM:INTernal:FUNcTION	303
SOURce[1 2]:PM:INTernal:FREQuency	304
SOURce[1 2]:PM:DEVIation	304

Additive Modulation (SUM) Commands	306
SUM Overview.....	306
SOURce[1 2]:SUM:STATe	307
SOURce[1 2]:SUM:MODulation:INPut.....	307
SOURce[1 2]:SUM:INTernal:FUNCTion	308
SOURce[1 2]:SUM:INTernal:FREQuency.....	309
SOURce[1 2]:SUM:AMPLitude.....	309
Pulse Width Modulation (PWM) Commands	311
PWM Overview.....	311
SOURce[1 2]:PWM:STATe.....	312
SOURce[1 2]:PWM:MODulation:INPut.....	312
SOURce[1 2]:PWM:INTernal:FUNCTion.....	313
SOURce[1 2]:PWM:INTernal:FREQuency.....	313
SOURce[1 2]:PWM:DUTY	314
Frequency Sweep Commands	316
Sweep Overview	316
SOURce[1 2]:SWEep:STATe	317
SOURce[1 2]:SWEep:TYPE	317
SOURce[1 2]:SWEep:MODE	318
SOURce[1 2]:SWEep:SHApe	318
SOURce[1 2]:SWEep:MANual:TRIGger	319
SOURce[1 2]:SWEep:FREQuency:START.....	319
SOURce[1 2]:SWEep:FREQuency:STOP	320
SOURce[1 2]:SWEep:FREQuency:CENTer.....	321
SOURce[1 2]:SWEep:FREQuency:SPAN	322
SOURce[1 2]:SWEep:FUNCTion	322
SOURce[1 2]:SWEep:TIME.....	323
SOURce[1 2]:SWEep:TRIGger	324
SOURce[1 2]:SWEep:AMPLitude:START	325
SOURce[1 2]:SWEep:AMPLitude:STOP.....	326
Burst Mode Commands	327
Burst Mode Overview.....	327
SOURce[1 2]:BURSt:STATe	329
SOURce[1 2]:BURSt:MODE	329
SOURce[1 2]:BURSt:NCYCles	330
SOURce[1 2]:BURSt:INTernal:PERiod	331
SOURce[1 2]:BURSt:PHASe.....	332
SOURce[1 2]:BURSt:TRIGger:MANual	333
SOURce[1 2]:BURSt:TRIGger.....	333
SOURce[1 2]:BURSt:TRIGger:DELay.....	334
SOURce[1 2]:BURSt:TRIGger:SLOPe.....	335
SOURce[1 2]:BURSt:GATE:POLarity.....	335
Arbitrary Waveform Commands	337
Arbitrary Waveform Overview.....	337

DATA:DAC.....	338
SOURce[1 2]:ARB:EDIT:COpy	339
SOURce[1 2]:ARB:EDIT:DELeTe	340
SOURce[1 2]:ARB:EDIT:DELeTe:ALL	340
SOURce[1 2]:ARB:EDIT:POINt	340
SOURce[1 2]:ARB:EDIT:PROTeCt	341
SOURce[1 2]:ARB:EDIT:PROTeCt:ALL	342
SOURce[1 2]:ARB:EDIT:UNProtect	342
SOURce[1 2]:ARB:BUILt:SINusoid	342
SOURce[1 2]:ARB:BUILt:SQUare.....	342
SOURce[1 2]:ARB:BUILt:PULSe.....	343
SOURce[1 2]:ARB:BUILt:RAMP	344
SOURce[1 2]:ARB:BUILt:SINC	344
SOURce[1 2]:ARB:BUILt:EXPRise	345
SOURce[1 2]:ARB:BUILt:EXPFall	345
SOURce[1 2]:ARB:BUILt:DC	346
SOURce[1 2]:ARB:BUILt:stair_ud	346
SOURce[1 2]:ARB:BUILt:stair_down	347
SOURce[1 2]:ARB:BUILt:stair_up	347
SOURce[1 2]:ARB:BUILt:absatan.....	347
SOURce[1 2]:ARB:BUILt:abssin	348
SOURce[1 2]:ARB:BUILt:abssinehalf.....	348
SOURce[1 2]:ARB:BUILt:ampalt	349
SOURce[1 2]:ARB:BUILt:attalt	349
SOURce[1 2]:ARB:BUILt:diric_even.....	350
SOURce[1 2]:ARB:BUILt:diric_odd.....	350
SOURce[1 2]:ARB:BUILt:gauspuls.....	351
SOURce[1 2]:ARB:BUILt:havercosine.....	351
SOURce[1 2]:ARB:BUILt:haversine.....	352
SOURce[1 2]:ARB:BUILt:n_pulse.....	352
SOURce[1 2]:ARB:BUILt:negramp.....	352
SOURce[1 2]:ARB:BUILt:rectpuls	353
SOURce[1 2]:ARB:BUILt:roundhalf.....	353
SOURce[1 2]:ARB:BUILt:sawtoot.....	354
SOURce[1 2]:ARB:BUILt:sinetra	354
SOURce[1 2]:ARB:BUILt:stepresp.....	355
SOURce[1 2]:ARB:BUILt:sinever	355
SOURce[1 2]:ARB:BUILt:trapezia.....	356
SOURce[1 2]:ARB:BUILt:tripulsI	356
SOURce[1 2]:ARB:BUILt:dlorentz	357
SOURce[1 2]:ARB:BUILt:gauss	357
SOURce[1 2]:ARB:BUILt:ln.....	358
SOURce[1 2]:ARB:BUILt:lorentz	358
SOURce[1 2]:ARB:BUILt:sinc.....	359
SOURce[1 2]:ARB:BUILt:sqrt	359
SOURce[1 2]:ARB:BUILt:xsquare.....	360

SOURce[1 2]:ARB:BUILt:arccos	360
SOURce[1 2]:ARB:BUILt:arccot.....	361
SOURce[1 2]:ARB:BUILt:arccsc.....	361
SOURce[1 2]:ARB:BUILt:arcsec.....	362
SOURce[1 2]:ARB:BUILt:arcsin	362
SOURce[1 2]:ARB:BUILt:arcsinh	363
SOURce[1 2]:ARB:BUILt:arctan.....	363
SOURce[1 2]:ARB:BUILt:arctanh.....	364
SOURce[1 2]:ARB:BUILt:cosh	364
SOURce[1 2]:ARB:BUILt:cot.....	365
SOURce[1 2]:ARB:BUILt:csc.....	365
SOURce[1 2]:ARB:BUILt:sec.....	366
SOURce[1 2]:ARB:BUILt:sech	366
SOURce[1 2]:ARB:BUILt:sinh	367
SOURce[1 2]:ARB:BUILt:tan.....	367
SOURce[1 2]:ARB:BUILt:tanh.....	368
SOURce[1 2]:ARB:BUILt:barthannwin	368
SOURce[1 2]:ARB:BUILt:bartlett	369
SOURce[1 2]:ARB:BUILt:blackman	369
SOURce[1 2]:ARB:BUILt:bohmanwin	370
SOURce[1 2]:ARB:BUILt:chebwin	370
SOURce[1 2]:ARB:BUILt:flattopwin.....	371
SOURce[1 2]:ARB:BUILt:hamming	371
SOURce[1 2]:ARB:BUILt:hann.....	372
SOURce[1 2]:ARB:BUILt:kaiser	372
SOURce[1 2]:ARB:BUILt:traing	373
SOURce[1 2]:ARB:BUILt:tukeywin.....	373
SOURce[1 2]:ARB:OUTPut	374
SOURce[1 2]:ARB:RATE	374
SOURce[1 2]:ARB:GATE	375
SOURce[1 2]:ARB:NCYClE.....	376
SOURce[1 2]:ARB:NCYClEs:CYClE	376
SOURce[1 2]:ARB:MANual:TRIGger	377
Tracking Commands	378
SOURce[1 2]:COUPle:FREQUency:MODE.....	378
SOURce[1 2]:COUPle:FREQUency:OFFSet.....	379
SOURce[1 2]:COUPle:FREQUency:RATio	380
SOURce[1 2]:COUPle:AMPLitude	381
SOURce[1 2]:TRACKing:STATe.....	381
Reference Commands	383
SOURce[1 2]:REFEreNce	383
SOURce[1 2]:REFEreNce:SYNChronous.....	383
Save and Recall Commands	384
*SAV	384
*RCL	384

MEMory:STATe:DELeTe	384
MEMory:STATe:DELeTe ALL	385
MEMory:STATe?	385

488.2 Common Commands

*IDN? System Query

Description Returns the function generator manufacturer, model number, serial number and firmware version number in the following format:
GW INSTEK,AFG-3032,SN:XXXXXXXX,Vm.mm

Query Syntax **IDN?**

Return parameter <string>

Example ***IDN?**
GW INSTEK,AFG-3032,SN:XXXXXXXX,Vm.mm
Returns the identification of the function generator.

*RST System Command

Description Reset the function generator to its factory default state.

Note Note the *RST command will not delete instrument save states in memory.

Syntax ***RST**

*TST? System Query

Description Performs a system self-test and returns a pass or fail judgment. An error message will be generated if the self test fails.

Note The error message can be read with the SYST:ERR? query.

Query Syntax ***TST?**

Return parameter	+0	Pass judgment
	+1	Fail judgment
Example	*TST? +0 The function generator passed the self-test.	

***OPC** System Command

Description	This command sets the Operation Complete Bit (bit 0) of the Standard Event Status Register after the function generator has completed all pending operations. For the AFG-30XX, the *OPC command is used to indicate when a sweep or burst has completed.
Note	Before the OPC bit is set, other commands may be executed.
Syntax	*OPC

***OPC?** System Query

Description	Returns the OPC bit to the output buffer when all pending operations have completed. I.e. when the OPC bit is set.
Note	Commands cannot be executed until the *OPC? query has completed.
Query Syntax	*OPC?
Return parameter	1
Example	*OPC? 1 Returns a "1" when all pending operations are complete.

***WAI** System Command

Description This command waits until all pending operations have completed before executing additional commands. I.e. when the OPC bit is set.

Note This command is only used for triggered sweep and burst modes.

Syntax ***WAI**

Status Register Commands

***CLS** System Command

Description The *CLS command clears all the event registers, the error queue and cancels an *OPC command.

Syntax ***CLS**

***ESE** System Command

Description The Standard Event Status Enable command determines which events in the Standard Event Status Event register can set the Event Summary Bit (ESB) of the Status Byte register. Any bit positions set to 1 enable the corresponding event. Any enabled events set bit 5 (ESB) of the Status Byte register.

Note The *CLS command clears the event register, but not the enable register.

Syntax ***ESE <enable value>**

Parameter <enable value> 0~255

Example ***ESE 20**
Sets a bit weight of 20 (bits 2 and 4).

Query Syntax ***ESE?**

Return Parameter	Bit	Register	Bit	Register
	0	Operation complete bit	4	Execution Error
	1	Not Used	5	Command Error
	2	Query Error	6	Not Used
	3	Device Error	7	Power On

Example ***ESE?**
 4
 Bit 2 is set.

***ESR?** System Command

Description Reads and clears the Standard Event Status Register. The bit weight of the standard event status register is returned.

Note The *CLS will also clear the standard event status register.

Query Syntax ***ESR?**

Return Parameter	Bit	Register	Bit	Register
	0	Operation Complete	4	Execution Error
	1	Not Used	5	Command Error
	2	Query Error	6	Not Used
	3	Device Error	7	Power On

Query Example ***ESR?**
 5
 Returns the bit weight of the standard event status register (bit 0 and 2).

***STB?** System Command

Description Reads the Status byte condition register.

Note Bit 6, the master summary bit, is not cleared.

Syntax ***STB?**

***SRE** System Command

Description The Service Request Enable Command determines which events in the Status Byte Register are allowed to set the MSS (Master summary bit). Any bit that is set to "1" can cause the MSS bit to be set.

Note The *CLS command clears the status byte event register, but not the enable register.

Syntax ***SRE <enable value>**

Parameter <enable value> 0~255

Example ***SRE 12**

Sets a bit weight of 12 (bits 2 and 3) for the service request enable register.

Query Syntax ***SRE?**

Return Parameter	Bit	Register	Bit	Register
	0	Not used	4	Message Available
	1	Not used	5	Standard Event
	2	Error Queue	6	Master Summary*
	3	Questionable Data	7	Not used

* The Master Summary (MSS) bit cannot be used to set itself.

Query Example ***SRE?**
12

Returns the bit weight of the status byte enable register.

***PSC** System Command

Description The Power-On Status Clear command is used to clear a number enable registers at power-on.

The following enable register groups are cleared when the *PSC command is enabled:

- Questionable data enable register
- Standard operation enabled register
- Status byte condition enable register
- Standard event enable register

Syntax ***PSC {OFF|ON}**

Parameter	OFF	Disables PSC.
	ON	Enables PSC.

Example ***PSC OFF**

Disables the Power-On Status Clear function.

Query Syntax ***PSC?**

Return Parameter	0	PSC disabled
	1	PSC enabled

Example ***PSC?**

0

PSC is disabled.

STATus:QUESTIONable:CONDition? System Command

Description Reads the Questionable Status Condition register. The bit weight of the register is returned.

Note This command will not clear the Status Questionable Condition register.

Query Syntax **STATus:QUESTIONable:CONDition?**

Return Parameter	Bit	Register	Bit	Register
-------------------------	-----	----------	-----	----------

0	Voltage overload	4	Over temperature
5	Loop unlock	7	Ext Mod Overload
8	Cal Error	9	External Reference

Query Example **STAT:QUES:COND?**

0

Returns the bit weight of the questionable status condition register (bit 0). Indicates that there are no errors.

STATus:QUESTIONable:EVENT?

System Command

Description Reads and clears the Questionable Status Event register. The bit weight of the register is returned.

Query Syntax **STATus:QUESTIONable:EVENT?**

Return Parameter	Bit	Register	Bit	Register
	0	Voltage overload	4	Over temperature
	5	Loop unlock	7	Ext Mod Overload
	8	Cal Error	9	External Reference

Query Example **STAT:QUES:EVEN?**

16

Returns the bit weight of the questionable status event register (bit 0). Indicates that an over temperature (bit 4) event has occurred.

STATus:QUESTIONable:ENABle

System Command

Description This command determines which events in the Questionable Status Register group are allowed to set the Questionable Data bit in the Status Byte register.

Syntax **STATus:QUESTIONable:ENABle<enable value>**

Parameter <enable value> 0~255

Example **STAT:QUES:ENAB 17**

Sets a bit weight of 17 (bits 0 and 4). I.e, enables voltage overload and over temperature bits.

Query Syntax **STATus:QUESTIONable:ENABLE?**

Return Parameter	Bit	Register	Bit	Register
	0	Voltage overload	4	Over temperature
	5	Loop unlock	7	Ext Mod Overload
	8	Cal Error	9	External Reference

Query Example **STAT:QUES:ENAB?**

17

Returns the bit weight of the questionable status enable register.

STATus:PRESet System Command

Description Clears the Questionable Status Enable registers.

Syntax **STATus:PRESet**

Example **STAT:PRES**

Clears the Questionable Status Enable registers.

System Commands

SYSTem:ERRor?

System Query

Description	Reads an error from the error queue. See page 404 for details regarding the error queue.
-------------	------------------------------------------------------------------------------------------

Query Syntax	SYSTem:ERRor?
--------------	----------------------

Return parameter	<string>	Returns an error string, <256 ASCII characters.
------------------	----------	-------------------------------------------------

Example	SYSTem:ERRor? -138 Suffix not allowed Returns an error string.
---------	------------------------------------------------------------------------------------

SYSTem:INTerface

System Command

Description	Selects the remote interface. USB is the factory default.
-------------	-----------------------------------------------------------

Note	There is no interface query.
------	------------------------------

Syntax	SYSTem:INTerface {GPIB LAN USB}
--------	----------------------------------------

Example	SYST:INT USB Sets the interface to USB.
---------	---------------------------------------------------

SYSTem:LOCal

System Command

Description	Sets the function generator to local mode. In local mode, all front panel keys are operational.
-------------	-------------------------------------------------------------------------------------------------

Syntax	SYSTem:LOCal
--------	---------------------

Example	SYST:LOC
---------	-----------------

SYSTem:REMOte System Command

Description	Disables the front panel keys and puts the function generator into remote mode.
Syntax	SYSTem:REMOte
Example	SYST:REM

SYSTem:LANGuage System Command

Description	Sets or queries the display language. Select the language shown on the function generator front-panel display. Only one language can be enabled at a time. SYSTem:LANGuage? query returns "CHIN", "ENF" or "TRCH".						
Note	Only one language can be set.						
Syntax	SYSTem:LANGuage {CHINese ENGLISH TRCHinese}						
Example	SYST:LANG ENG Sets the display language to English.						
Query Syntax	SYSTem:LANGuage?						
Return Parameter	<table border="1" style="width: 100%;"> <tr> <td>CHIN</td> <td>Chinese</td> </tr> <tr> <td>ENG</td> <td>English</td> </tr> <tr> <td>TRCH</td> <td>Traditional Chinese</td> </tr> </table>	CHIN	Chinese	ENG	English	TRCH	Traditional Chinese
CHIN	Chinese						
ENG	English						
TRCH	Traditional Chinese						
Query Example	SYST:LANG? ENG The current language is English.						

SYSTem:VERSion? System Query

Description	Performs a system version query. Returns a string with the instrument, firmware version, FPGA revision and bootloader.
-------------	------------------------------------------------------------------------------------------------------------------------

Query Syntax	SYSTem:VERSion?
--------------	------------------------

Return parameter	<string>
------------------	----------

Example	SYST:VERS?
---------	-------------------

AFG-3032 VX.XXX_XXXX FPGA:XXXX

BootLoad:XXXX

Returns the date and version for that date.

Apply Commands

The APPLy command has 8 different types of outputs (Sine, Square, Ramp, Pulse, Noise, Triangle, Harmonic, User). The command is the quickest, easiest way to output waveforms remotely. Frequency, amplitude and offset can be specified for each function.

As only basic parameters can be set with the Apply command, other parameters use the instrument default values.

The Apply command will set the trigger source to immediate and disable burst, modulation and sweep modes. Turns on the output command OUTP[1 | 2] ON. The termination setting will not be changed.

As the frequency, amplitude and offset parameters are in nested square brackets, amplitude can only be specified if the frequency has been specified and offset can only be specified if amplitude has been set. For the example:

```
SOURce[1 | 2]:APPLy:SINusoid [<frequency> [,<amplitude>
[,<offset>] ]]
```

Output Frequency For the output frequency, MINimum, MAXimum and DEFault can be used. The default frequency for all functions is set to 1 kHz. The maximum and minimum frequency depends on the function used. If a frequency output that is out of range is specified, the max/min frequency will be used instead. A "Data out range error will be generated" from the remote terminal.

**Output
Amplitude**

When setting the amplitude, MINimum, MAXimum and DEFault can be used. The range depends on the function being used and the output termination (50Ω or high impedance). The default amplitude for all functions is 100 mVpp (50Ω).

If the amplitude has been set and the output termination is changed from 50Ω to high impedance, the amplitude will double. Changing the output termination from high impedance to 50Ω will half the amplitude.

Vrms, dBm or Vpp units can be used to specify the output unit to use with the current command. The SOURce[1 | 2]:VOLT:UNIT command can be used to set the units when no unit is specified with the Apply command. If the output termination is set to high impedance, dBm units cannot be used. The units will default to Vpp.

The output amplitude can be affected by the function and unit chosen. Vpp and Vrms or dBm values may have different maximum values due to differences such as crest factor. For example, a 5Vrms square wave must be adjusted to 3.536 Vrms for a sine wave.

DC Offset voltage The offset parameter can be set to MINimum, MAXimum or DEFault. The default offset is 0 volts. The offset is limited by the output amplitude as shown below.

$$|V_{offset}| < V_{max} - V_{pp}/2$$

If the output specified is out of range, the maximum offset will be set.

The offset is also determined by the output termination (50Ω or high impedance). If the offset has been set and the output termination has changed from 50Ω to high impedance, the offset will double. Changing the output termination from high impedance to 50Ω will half the offset.

SOURce[1 2]:APPLY:SINusoid		Source Specific Command
Description	Outputs a sine wave from the selected channel when the command has executed. Frequency, amplitude and offset can also be set.	
Syntax	SOURce[1 2]:APPLY:SINusoid [<frequency> [,<amplitude> [,<offset>]]]	
Parameter	<frequency>	1μHz~30MHz (20MHz AFG-3021/3022)
	<amplitude>	1mV~10V (50Ω) (3.536 Vrms)
	<offset>	0~4.99V (50Ω)
Example	SOUR1:APPL:SIN 2KHZ,MAX,MAX Sets frequency to 2kHz and sets the amplitude and offset to the maximum.	

SOURce[1 2]:APPLY:SQUare		Source Specific Command
Description	Outputs a square wave from the selected channel when the command has executed. Frequency, amplitude and offset can also be set. The duty cycle is set to 50%.	
Syntax	SOURce[1 2]:APPLY:SQUare [<frequency> [,<amplitude> [,<offset>]]]	

Parameter	<frequency>	1μHz~30MHz (20MHz AFG-3021/3022)
	<amplitude>	1mV~10V (50Ω)
	<offset>	0~4.99V (50Ω)

Example **SOUR1:APPL:SQU 2KHZ,MAX,MAX**
 Sets frequency to 2kHz and sets the amplitude and offset to the maximum.

SOURce[1|2]:APPLy:RAMP Source Specific Command

Description Outputs a ramp wave from the selected channel when the command has executed. Frequency, amplitude and offset can also be set. The symmetry is set to 100%.

Syntax **SOURce[1|2]:APPLy:RAMP [<frequency> [,<amplitude> [,<offset>]]]**

Parameter	<frequency>	1μHz~1MHz
	<amplitude>	1mV~10V (50Ω)
	<offset>	0~4.99V (50Ω)

Example **SOUR1:APPL:RAMP 2KHZ,MAX,MAX**
 Sets frequency to 2kHz and sets the amplitude and offset to the maximum.

SOURce[1|2]:APPLy:PULSe Source Specific Command

Description Outputs a ramp wave from the selected channel when the command has executed. Frequency, amplitude and offset can also be set.

Note	The PW settings from the SOURce[1]:PULS: WIDT command are preserved. Edge and pulse width may be adjusted to supported levels.	
	Repetition rates will be approximated from the frequency. For accurate repetition rates, the period should be adjusted using the SOURce[1]:PULS:PER command	
Syntax	SOUR[1 2]:APPLy:PULSe [<frequency> [,<amplitude> [,<offset>]]]	
Parameter	<frequency>	1 μ Hz~25MHz (20MHz AFG-3021/3022)
	<amplitude>	1mV~10V (50 Ω)
	<offset>	0~4.99V (50 Ω)
Example	SOUR1:APPL:PULS 1KHZ,MIN,MAX	
	Sets the frequency to 1kHz, sets the amplitude to the minimum and the offset to the maximum.	

	SOURce[1 2]:APPLy:NOISe	Source Specific Command
Description	Outputs white noise (no set bandwidth). Amplitude and offset can also be set.	
Note	Frequency cannot be used with the noise function; however a value (or DEFault) must be specified. The frequency is remembered for the next function used.	
Syntax	SOURce[1 2]:APPLy:NOISe [<frequency DEFault> [,<amplitude> [,<offset>]]]	
Parameter	<frequency DEFault>	Not applicable
	<amplitude>	1mV~10V (50 Ω)
	<offset>	0~4.99V (50 Ω)
Example	SOUR1:APPL:NOIS DEF,3.0,1.0	
	Sets the amplitude to 3 volts with an offset of 1 volt.	

SOURce[1 2]:APPLY:TRIangle		Source Specific Command
Description	Outputs a triangle wave from the selected channel when the command has executed. Frequency, amplitude and offset can also be set.	
Syntax	SOURce[1 2]:APPLY:TRIangle [<frequency> [,<amplitude> [,<offset>]]]	
Parameter	<frequency> <amplitude> <offset>	1μHz~1MHz 1mV~10V (50Ω) 0~4.99V (50Ω)
Example	SOUR1:APPL:TRI 2khz,3.0,1.0 Sets the frequency to 1 MHz with an amplitude of 3 volts and with an offset of 1 volt.	

SOURce[1 2]:APPLY:DC		Source Specific Command
Description	Outputs a DC signal from the selected channel when the command has executed. Amplitude and offset can also be set.	
Note	Frequency cannot be used with the DC function; however a value (or DEFault) must be specified.	
Syntax	SOURce[1 2]::APPLY:DC [<frequency> DEFault[,<amplitude> [,<offset>]]]	
Parameter	<frequency> DEFault <amplitude> <offset>	1μHz~1MHz 1mV~10V (50Ω) 0~4.99V (50Ω)
Example	SOUR1:APPL:DC DEF,3.0,1.0 Sets the DC voltage to 4 volts (amplitude of 3V with an offset of 1 volt).	

SOURce[1 2]:APPLY:HARMonic		Source Specific Command
Description	Outputs a sine wave with harmonic components from the selected channel when the command has executed. Frequency, amplitude and offset can also be set. The maximum frequency is limited by the highest order. Highest order n: maximum frequency is 30MHz/n or 20MHz/n for AFG-3021/3022).	
Syntax	SOURce[1 2]:APPLY:HARMonic [<frequency> [,<amplitude> [,<offset>]]]	
Parameter	<frequency>	1μHz~30MHz (20MHz AFG-3021/3022)
	<amplitude>	1mV~10V (50Ω) (3.536 Vrms)
	<offset>	0~4.99V (50Ω)
Example	SOUR1:APPL:HARM 2KHZ,MAX,MAX Sets the frequency to 2kHz and sets the amplitude and offset to the maximum.	

SOURce[1 2]:APPLY:USER		Source Specific Command
Description	Outputs an arbitrary waveform from the selected channel. The output is that specified from the SOURce[1 2]:ARB:BUILt:ARB_waveform command (Example: SOURce[1 2]:ARB:BUILt:SQUare).	
Note	Frequency and amplitude cannot be used with the DC function; however a value (or DEFault) must be specified. The values are remembered for the next function used.	
Syntax	SOURce[1]:APPLY:USER [<frequency> [,<amplitude> [,<offset>]]]	

Parameter	<frequency>	1μHz~125MHz
	<amplitude>	0~10V (50Ω)
	<offset>	0~5V (50Ω)

Example **SOUR1:APPL:USER**

SOURce[1|2]:APPLy?

Source Specific
Command

Description Outputs a string with the current settings for the selected channel.

Note The string can be passed back appended to the Apply Command.

Syntax **SOURce[1|2]:APPLy?**

Return Parameter <string> Function, frequency, amplitude, offset

Example **SOUR1:APPL?**
 SIN +5.000000000000E+03,+3.0000E+00,-2.50E+00
 Returns a string with the current function and parameters, Sine, 5kHz, 3Vpp, -2.5V offset.

Output Commands

Unlike the Apply commands, the Output commands are low level commands to program the function generator.

This section describes the low-level commands used to program the function generator. Although the APPLY command provides the most straightforward method to program the function generator, the low-level commands give you more flexibility to change individual parameters.

SOURCE[1 2]:FREQUENCY		Source Specific Command
Description	Sets the output frequency for the selected channel and the query command returns the current frequency setting.	
Note	The maximum and minimum frequency depends on the function mode.	
	Sine, Square	1 μ Hz~30MHz (20MHz AFG-3021/3022)
	Ramp, Triangle	1 μ Hz~1MHz
	Pulse	1 μ Hz~25MHz (20MHz AFG-3021/3022)
	Noise	Not applicable
	User	1pHz~125MHz

If the function mode is changed and the current frequency setting is not supported by the new mode, the frequency setting will be altered to next highest value.

The duty cycle of square waveforms depends on the frequency settings.

20% to 80% (*frequency* < 25 MHz)

40% to 60% (25 MHz < *frequency* ≤ 30 MHz)

If the frequency is changed and the set duty cycle cannot support the new frequency, the highest duty cycle available at that frequency will be used. A “settings conflict” error will result from the above scenario.

Syntax **SOURce[1|2]:FREQuency {<frequency>|MINimum|MAXimum}**

Example **SOUR1:FREQ MAX**
Sets the frequency to the maximum for the current mode.

Query Syntax **SOURce[1|2]:FREQuency?**

Return Parameter	<NR3>	Returns the frequency for the current mode.
------------------	-------	---------------------------------------------

Example **SOUR1:FREQ? MAX**
+1.0000000000000E+03
The maximum frequency that can be set for the current function is 1MHz.

SOURce[1 2]:AMPLitude	Source Specific Command
------------------------------	-------------------------

Description	Sets the output amplitude or queries the current amplitude settings for the selected channel.
-------------	-----------------------------------------------------------------------------------------------

Note	The maximum and minimum amplitude depends on the output termination. The default amplitude for all functions is 3Vpp (50Ω). If the amplitude has been set and the output termination is changed
------	-------------------------------------------------------------------------------------------------------------------------------------------------------------------------------------------------

from 50Ω to high impedance, the amplitude will double. Changing the output termination from high impedance to 50Ω will half the amplitude.

The offset and amplitude are related by the following equation.

$$|V_{offset}| < V_{max} - V_{pp}/2$$

If the output termination is set to high impedance, dBm units cannot be used. The units will default to Vpp.

The output amplitude can be affected by the function and unit chosen. Vpp and Vrms or dBm values may have different maximum values due to differences such as crest factor. For example, a 5Vrms square wave must be adjusted to 3.536 Vrms for a sine wave.

The amplitude units can be explicitly used each time the SOURce[1]:AMPLitude command is used. Alternatively, the SOURce[1 | 2]:VOLT:UNIT command can be used to set the amplitude units for all commands.

Syntax	SOURce[1 2]:AMPLitude {< amplitude> MINimum MAXimum}	
Example	SOUR1:AMPL MAX Sets the amplitude to the maximum for the current mode.	
Query Syntax	SOURce[1 2]:AMPLitude? {MINimum MAXimum}	
Return Parameter	<NR3>	Returns the amplitude for the current mode.
Example	SOUR1:AMPL? MAX +5.0000E+00 The maximum amplitude that can be set for the current function is 5 volts.	

SOURce[1 2]:PHASe		Source Specific Command
Description	Sets or queries the output phase angle (-360°~360°) of the selected channel. The default phase is 0°.	
Syntax	SOURce[1 2]:PHASe{<angle> MINimum MAXimum}	
Example	SOUR[1]:PHAS:MAX Sets the output phase to the maximum.	
Query Syntax	SOURce[1 2]:PHASe {MINimum MAXimum}	
Return Parameter	<NR3>	Returns the phase in degrees.
Example	SOUR1:PHAS? +1.2000E+01 The phase is set to 12°.	

SOURce[1 2]:PHASe:ALIGn		Source Specific Command
Description	Aligns the timebase of both channels but doesn't change the phase deviation of the channels. In other words it re-calibrates the phase difference between both of the channels.	
Syntax	SOURce[1 2]:PHASe:ALIGn	
Example	SOUR[1]:PHAS:ALIG Turns on the phase align function.	

SOURce[1 2]:DCOffset		Source Specific Command
Description	Sets or queries the DC offset for the current mode.	
Note	The offset parameter can be set to MINimum, MAXimum or DEFault. The default offset is 0 volts. The offset is limited by the output amplitude as shown below.	

$$|V_{offset}| < V_{max} - V_{pp}/2$$

If the output specified is out of range, the maximum offset will be set.

The offset is also determined by the output termination (50Ω or high impedance). If the offset has been set and the output termination has changed from 50Ω to high impedance, the offset will double. Changing the output termination from high impedance to 50Ω will half the offset.

Syntax	SOURce[1 2]:DCOffset {< offset> MINimum MAXimum}	
Example	SOUR1:DCO MAX Sets the offset to the maximum for the current mode.	
Query Syntax	SOURce[1 2]:DCOffset? {MINimum MAXimum}	
Return Parameter	<NR3>	Returns the offset for the current mode.
Example	SOUR1:DCO? +3.0000E+00 The offset for the current mode is set to +3 volts.	

SOURce[1|2]:SQUare:DCYCLE Source Specific Command

Description Sets or queries the duty cycle for square waves only. The setting is remembered if the function mode is changed. The default duty cycle is 50%.

Note The duty cycle of square waveforms depend on the frequency settings.
20% to 80% (*frequency* < 25 MHz)
40% to 60% (25 MHz < *frequency* ≤ 30 MHz)

If the frequency is changed and the set duty cycle cannot support the new frequency, the highest

duty cycle available at that frequency will be used. A “settings conflict” error will result from the above scenario.

For square waveforms, the Apply command and AM/FM modulation modes ignore the duty cycle settings.

Syntax	SOURce[1 2]:SQUare:DCYCLE {< percent> MINimum MAXimum}	
Example	SOUR1:SQU:DCYC MAX Sets the duty cycle to the highest possible for the current frequency.	
Query Syntax	SOURce[1 2]:SQUare:DCYCLE? {MINimum MAXimum}	
Return Parameter	<NR3>	Returns the duty cycle as a percentage.

Example **SOUR1:SQU:DCYC?**
 +5.00E+01
 The duty cycle is set 50%.

SOURce[1|2]:RAMP:SYMMetry Source Specific Command

Description Sets or queries the symmetry for ramp waves only. The setting is remembered if the function mode is changed. The default symmetry is 50%.

Note For ramp waveforms, the Apply command and AM/FM modulation modes ignore the current symmetry settings.

Syntax **SOURce[1|2]:RAMP:SYMMetry {< percent> |MINimum|MAXimum}**

Example **SOUR1:RAMP:SYMM MAX**
 Sets the symmetry to the 100%.

Query Syntax **SOURce[1|2]:RAMP:SYMMetry? {MINimum|MAXimum}**

Return Parameter	<NR3>	Returns the symmetry as a percentage.
------------------	-------	---------------------------------------

Example **SOUR1:RAMP:SYMMetry?**
 +1.0000E+02
 The symmetry is set as 100%.

OUTPut[1|2] Source Specific Command

Description Enables/Disables or queries the front panel output. The default is set to off.

Note If the output is overloaded by an external voltage, the output will turn off and an error message will be displayed. The overload must first be removed before the output can be turned on again with the output command.
 Using the Apply command automatically sets the front panel output to on.

Syntax **OUTPut[1|2] {OFF|ON}**

Example **OUTP1 ON**
 Turns the output on for channel 1.

Query Syntax **OUTPut[1|2]?**

Return Parameter	1	ON
	0	OFF

Example **OUTP1?**
 1
 The output is currently on for channel 1.

OUTPut[1]:LOAD		Source Specific Command
Description	<p>Sets or queries the output termination. Two impedance settings can be chosen, DEFault (50Ω) and INFinity (high impedance >10 kΩ).</p> <p>The output termination is to be used as a reference only. If the output termination is set 50Ω but the actual load impedance is not 50Ω, then the amplitude and offset will not be correct.</p>	
Note	<p>If the amplitude has been set and the output termination is changed from 50Ω to high impedance, the amplitude will double. Changing the output termination from high impedance to 50Ω will half the amplitude.</p> <p>If the output termination is set to high impedance, dBm units cannot be used. The units will default to Vpp.</p>	
Syntax	OUTPut[1]:LOAD {DEFault INFinity}	
Example	<p>OUTP1:LOAD DEF</p> <p>Sets the output termination to 50Ω for channel 1.</p>	
Query Syntax	OUTPut[1]:LOAD?	
Return Parameter	DEF	Default
	INF	INFinity
Example	<p>OUTP1:LOAD?</p> <p>DEF</p> <p>The output is set to the default of 50Ω for channel 1.</p>	

OUTPut[1 2]:SYNC		Source Specific Command
Description	<p>This command turns waveform gating on or off for the selected channel's output. When gating is turned on, it allows the output signal to be output when the trigger input is asserted. It does not turn the output on, change the phase or other timing characteristics.</p> <p>For example: When gating is turned on the waveform is output when the trigger signal goes high. When the trigger signal is low the waveform continues to be generated internally. The next time the trigger signal is high, the internally generated waveform is output at that particular point in time, instead of a newly generated waveform.</p>	
Syntax	OUTPut[1 2]:SYNC {OFF ON}	
Example	OUTP1:SYNC ON Turns gating on for channel 1.	
Query Syntax	OUTPut[1 2]:SYNC?	
Return Parameter	1	ON
	0	OFF
Example	OUTP1:SYNC? 1 The sync output is enabled for channel 1.	

SOURce[1]:VOLTage:UNIT		Source Specific Command
Description	Sets or queries the output amplitude units. There are three types of units: VPP, VRMS and DBM.	
Note	<p>The units set with the VOLTage:UNIT command will be used as the default unit for all amplitude units unless a different unit is specifically used for a command.</p> <p>If the output termination is set to high impedance, dBm units cannot be used. The Units will automatically default to Vpp.</p>	
Syntax	SOURce[1]:VOLTage:UNIT {VPP VRMS DBM}	
Example	<p>SOUR1:VOLT:UNIT VPP</p> <p>Sets the amplitude units to Vpp for channel 1.</p>	
Query Syntax	SOURce[1]:VOLTage:UNIT?	
Return Parameter	VPP	Vpp
	VRMS	Vrms
	DBM	dBm
Example	<p>SOUR1:VOLT:UNIT?</p> <p>VPP</p> <p>The amplitude units are set to Vpp.</p>	

Pulse Configuration Commands

The pulse chapter is used to control and output pulse waveforms. Unlike the APPLY command, low level control is possible including setting the rise time, fall time, period and pulse width.

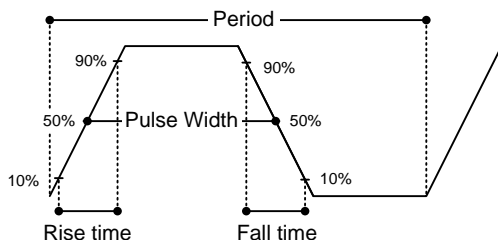

	Source Specific Command
	SOURce[1 2]:PULSe:WIDTh
Description	Sets or queries the pulse width. The default pulse width is 500us. Pulse width is defined as the time from the rising to falling edges (at a threshold of 50%).
Note	The pulse width is restricted to the following limitations: $\text{Pulse Width} - 0.625 * [(\text{Rise Time} - 0.6\text{nS}) + (\text{Fall Time} - 0.6\text{nS})] \geq 0$ $\text{Period} \geq \text{Pulse Width} + 0.625 * [(\text{Rise Time} - 0.6\text{nS}) + (\text{Fall Time} - 0.6\text{nS})]$
Syntax	SOURce[1 2]:PULSe:WIDTh {<seconds> MINimum MAXimum}
Example	SOUR1:PULS:WIDTh MAX Sets the pulse width to the maximum allowed.
Query Syntax	SOURce[1 2]:PULSe:WIDTh? [MINimum MAXimum]
Return Parameter	<seconds> 20ns ~ 999.83 ks
Example	SOUR1:PULS:WIDTh? MIN +2.0000E-08

The pulse width is set to 20 nanoseconds.

SOURce[1 2]:PULSe:DCYClE		Source Specific Command
Description	Sets or queries the pulse duty cycle.	
Note	The duty cycle is limited by the rise/fall time as noted below: $Duty \geq 0.625 \times 100 \times [\text{rise time} - 0.6\text{ns} + \text{fall time} - 0.6\text{ns}] / \text{period}$ $Duty \leq 100 - \{62.5 \times [(\text{rise time} - 0.6\text{ns}) + (\text{fall time} - 0.6\text{ns})] / \text{period}\}$	
Syntax	SOURce[1 2]:PULSe:DCYClE{<percent> MINimum MAXimum}	
Example	SOUR1:PULS:DCYC MAX Sets the duty to the maximum allowed.	
Query Syntax	SOURce[1 2]:PULSe:DCYClE? [MINimum MAXimum]	
Return Parameter	<NR3>	0.0170%~99.983% Resolution 0.0001%
Example	SOUR1:PULS:DCYC? +1.0000E+01 The duty cycle is set to 10%	

SOURce[1 2]:PULSe:EDGEtime		Source Specific Command
Description	Sets or queries the pulse edge time. The default edge time is 10us. This command will set the rise time = the fall time = edge time.	
Note	The edge time is limited by the pulse width as noted below: $Pulse\ Width - 0.625 * [(Rise\ Time - 0.6nS) + (Fall\ Time - 0.6nS)] \geq 0$ $Period \geq Pulse\ Width + 0.625 * [(Rise\ Time - 0.6nS) + (Fall\ Time - 0.6nS)]$	

Syntax	SOURce[1 2]:PULSe:EDGEtime{<seconds> MINimum MAXimum}
Example	SOUR1:PULS:EDGE MAX Sets the edge time to the maximum allowed.
Query Syntax	SOURce[1 2]:PULSe:EDGEtime? [MINimum MAXimum]
Return Parameter	<NR3> 9.32ns ~ 799.9ks
Example	SOUR1:PULS:EDGE? MIN +9.3200E-09 The edge time is 9.32 nanoseconds.

SOURce[1 2]:PULSe:RISE		Source Specific Command
Description	Sets or queries the pulse rise time. The default rise time is 10us. The rise and fall time can be different. Range: 9.32ns ~ 799.9ks	
Note	The rise time is limited by the pulse width, period and fall time as noted below: Pulse Width - $0.625 * [(Rise\ Time - 0.6nS) + (Fall\ Time - 0.6nS)] \geq 0$ Period \geq Pulse Width + $0.625 * [(Rise\ Time - 0.6nS) + (Fall\ Time - 0.6nS)]$	
Syntax	SOURce[1 2]:PULSe:RISE{<seconds> MINimum MAXimum}	
Example	SOUR1:PULS:RISE MAX Sets the rise time to the maximum allowed.	
Query Syntax	SOURce[1 2]:PULSe:RISE? [MINimum MAXimum]	
Return Parameter	<NR3> 9.32ns ~ 799.9ks	
Example	SOUR1:PULS:FALL? MIN +9.3200E-09 The minimum rise time is 9.32 nanoseconds.	

SOURce[1 2]:PULSe:FALL		Source Specific Command
Description	Sets or queries the pulse fall time. The default fall time is 10us. The rise and fall time can be different. Range: 9.32ns ~ 799.9ks	
Note	The fall time is limited by the pulse width, period and rise time as noted below: $\text{Pulse Width} - 0.625 * [(\text{Rise Time} - 0.6\text{nS}) + (\text{Fall Time} - 0.6\text{nS})] \geq 0$ $\text{Period} \geq \text{Pulse Width} + 0.625 * [(\text{Rise Time} - 0.6\text{nS}) + (\text{Fall Time} - 0.6\text{nS})]$	
Syntax	SOURce[1 2]:PULSe:FALL{<seconds> MINimum MAXimum}	
Example	SOUR1:PULS:FALL MAX Sets the fall time to the maximum allowed.	
Query Syntax	SOURce[1 2]:PULSe:FALL? [MINimum MAXimum]	
Return Parameter	<NR3>	9.32ns ~ 799.9ks
Example	SOUR1:PULS:FALL? MIN +9.3200E-09 The minimum fall time is 9.32 nanoseconds.	

Harmonic Commands

SOURce[1 2]:HARMonic:TOTAL		Source Specific Command
Description	Sets the highest order harmonic for the harmonic output. By default this is set to 2.	
Syntax	SOURce[1 2]:HARMonic:TOTAL{<id> MINimum MAXimum}	
Example	SOUR1:HARMonic:TOTAL MAX	

Sets the highest order harmonic to the maximum allowed.

Query Syntax **SOURce[1|2]:HARMonic:TOTAL?
[MINimum|MAXimum]**

Return Parameter <NR1> 2 ~ 8

Example **SOUR1:HARM:? MIN**
2
Returns the minimum harmonic.

SOURce[1|2]:HARMonic:TYPE Source Specific Command

Description Specifies which harmonics are output; odd, even, all or user specified.

Syntax **SOURce[1|2]:HARMonic:TYPE
{EVEN|ODD|ALL|USER,1000001}**

Parameter/
Return Parameter <EVEN> Output all even orders

<ODD> Output all odd orders

<ALL> Output all orders, subject to the number specified in "SOURce[1|2]:HARMonic:TOTAL" command.

<USER,
X¹X²X³X⁴X⁵X⁶X⁷X⁸> Outputs only the specified orders, where X = Boolean (0, 1) X^X = order number.

Example **SOURce1:HARMonic:TYPE USER,11000001**
Outputs only the 2nd and 8th harmonic. (1st harmonic is the fundamental frequency)

Query Syntax **SOURce[1|2]:HARMonic:TYPE?**

Example **SOUR1:HARM:TYPE?**
EVEN 11000000

Returns EVEN harmonic (Limited to the 2nd harmonic).

SOURce[1|2]:HARMonic:ORDER Source Specific Command

Description Sets or queries the amplitude and phase of each order. By default, each order is set to 3Vpp, with a phase of 0°.

Syntax **SOURce[1|2]:HARMonic:ORDER {<id>,<amplitude>,<phase>}**

Parameter/ Return Parameter	<id>	<NR1> Order number: 2 ~8
	<amplitude>	<NR3> Amplitude of the selected order: 1mV ~ 10V (50ohm impedance)
	<phase>	<NR3> Phase: -360 ~ -360°

Example **SOURce1:HARMonic:ORDER 2,3.0,180**
Sets the 2nd harmonic to 3.0Vpp and a phase of 180°.

Query Syntax **SOURce[1|2]:HARMonic:ORDER? <id>**
Returns the <id>,<amplitude>,<phase>.

Example **SOUR1:HARM:ORDE? 2**
2;,3.000E+00,1.800E+02
Returns the 2nd harmonic settings as 3Vpp with a phase of 180°.

SOURce[1|2]:HARMonic:DISPlay Source Specific Command

Description Sets or queries whether the screen shows the harmonics in the frequency or time domain. The default setting is time domain.

Syntax **SOURce[1|2]:HARMonic:DISPlay {FREQuency|TIME}**

Parameter/ Return Parameter	FREQuency	Sets the display to frequency
	TIME	Sets the display to time
Example	SOURce1:HARMonic:DISPlay TIME Sets the display to TIME.	
Query Syntax	SOURce[1 2]:HARMonic:DISPlay? Returns TIME or FREQ.	
Example	SOUR1:HARM:DISP? TIME Returns the display format as TIME.	

Amplitude Modulation (AM) Commands

AM Overview

To successfully create an AM waveform, the following commands must be executed in order.

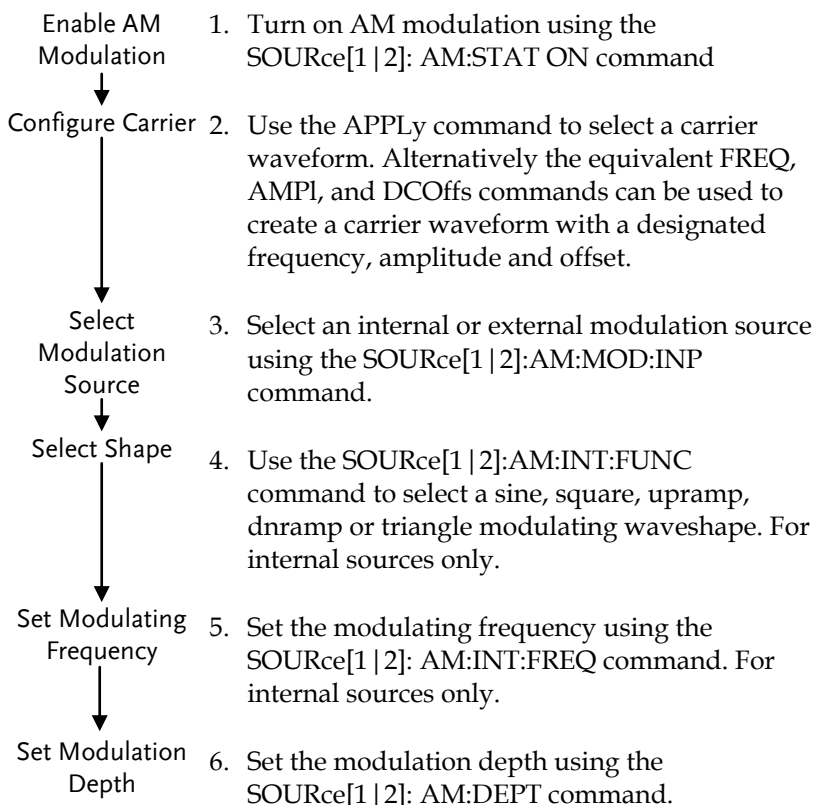

SOURce[1 2]:AM:STATe		Source Specific Command
Description	Sets or disables AM modulation for the selected channel. By default AM modulation is disabled. AM modulation must be enabled before setting other parameters.	
Note	Burst or sweep mode will be disabled if AM modulation is enabled on the same channel. As only one modulation is allowed on a channel at any one time, other modulation modes will be disabled when AM modulation is enabled.	
Syntax	SOURce[1 2]:AM:STATe {OFF ON}	
Example	SOUR1:AM:STAT ON Enables AM modulation.	
Query Syntax	SOURce[1 2]:AM:STATe?	
Return Parameter	0	Disabled (OFF)
	1	Enabled (ON)
Example	SOUR1:AM:STAT? 1 AM modulation mode is currently enabled.	

SOURce[1 2]:AM:MODulation:INPut		Source Specific Command
Description	Sets or queries the modulation source as internal or external for the selected channel. Internal is the default modulation source.	
Note	If an external modulation source is selected, modulation depth is limited to $\pm 5V$ from the MOD INPUT terminal on the rear panel. For example, if modulation depth is set to 100%, then the maximum amplitude is +5V, and the minimum amplitude is -5V.	

Syntax	SOURce[1 2]:AM:MODulation:INPut {INTernal EXTernal}		
Example	SOUR1:AM:MOD:INP EXT Sets the modulation source to external.		
Query Syntax	SOURce[1 2]:AM:MODulation:INPut?		
Return Parameter	INT	Internal	
	EXT	External	
Example	SOUR1:AM:MOD:INP? INT The modulation source is set to internal.		

SOURce[1|2]:AM:INTernal:FUNctIon Source Specific Command

Description	Sets the shape of the modulating waveform from sine, square, triangle, upramp and dn ramp for the selected channel. The default shape is sine.			
Note	Square and triangle waveforms have a 50% duty cycle. Upramp and dn ramp have a symmetry of 100% and 0%, respectively.			
Syntax	SOURce[1 2]:AM:INTernal:FUNctIon {SINusoid SQUare TRIangle UPRamp DNRamp}			
Example	SOUR1:AM:INT:FUNC SIN Sets the AM modulating wave shape to sine.			
Query Syntax	SOURce[1 2]:AM:INTernal:FUNctIon?			
Return Parameter	SIN	Sine	UPRAMP	Upramp
	SQU	Square	DNRAMP	Dn ramp
	TRI	Triangle		
Example	SOUR1:AM:INT:FUNC? SIN The shape for the modulating waveform is Sine.			

SOURce[1 2]:AM:INTernal:FREQuency		Source Specific Command
Description	Sets the frequency of the internal modulating waveform only for the selected channel. The default frequency is 100Hz.	
Syntax	SOURce[1 2]:AM:INTernal:FREQuency {<frequency> MINimum MAXimum}	
Parameter	<frequency>	2mHz~ 20kHz
Example	SOUR1:AM:INT:FREQ +1.0000E+02 Sets the modulating frequency to 100Hz.	
Query Syntax	SOURce[1 2]:AM:INTernal:FREQuency? [MINimum MAXimum]	
Return Parameter	<NR3>	Returns the frequency in Hz.
Example	SOUR1:AM:INT:FREQ? MIN +1.0000E+02 Returns the minimum frequency allowed.	
SOURce[1 2]:AM:DEPTh		Source Specific Command
Description	Sets or queries the modulation depth for internal sources only for the selected channel. The default is 100%.	
Note	The function generator will not output more than $\pm 5V$, regardless of the modulation depth. The modulation depth of an external source is controlled using the $\pm 5V$ MOD INPUT terminal on the rear panel, and not the SOURce[1]:AM:DEPTH command.	
Syntax	SOURce[1 2]:AM:DEPTh {<depth in percent> MINimum MAXimum}	
Parameter	<depth in percent>	0~120%

Example	SOUR1:AM:DEPT 50 Sets the modulation depth to 50%.
Query Syntax	SOURce[1 2]:AM:DEPT? [MINimum MAXimum]
Return Parameter	<NR3> Return the modulation depth as a percentage.
Example	SOUR1:AM:DEPT? +1.0000E+02 The modulation depth is 100%.

Frequency Modulation (FM) Commands

FM Overview

The following is an overview of the steps required to generate an FM waveform.

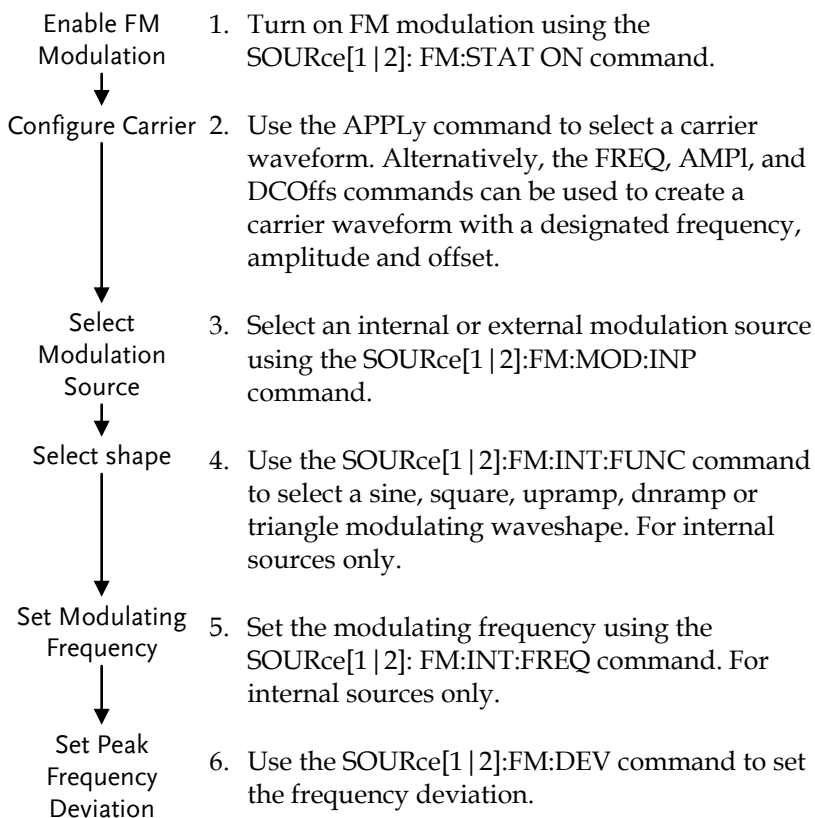

SOURce[1 2]:FM:STATe		Source Specific Command
Description	Sets or disables FM modulation for the selected channel. By default FM modulation is disabled. FM modulation must be enabled before setting other parameters.	
Note	Burst or sweep mode will be disabled if FM modulation is enabled on the same channel. As only one modulation is allowed at any one time on the same channel, other modulation modes will be disabled when FM modulation is enabled.	
Syntax	SOUR[1 2]:FM:STATe {OFF ON}	
Example	SOUR1:FM:STAT ON Enables FM modulation.	
Query Syntax	SOURce[1 2]:FM:STATe?	
Return Parameter	0	Disabled (OFF)
	1	Enabled (ON)
Example	SOUR1:FM:STAT? 1 FM modulation mode is currently enabled.	
SOURce[1 2]:FM:MODulation:INPut		Source Specific Command

Description	Sets or queries the modulation source as internal or external for the selected channel. Internal is the default modulation source.	
Note	If an external modulation source is selected, modulation depth is limited to $\pm 5V$ from the MOD INPUT terminal on the rear panel. For example, if modulation depth is set to 100%, then the maximum amplitude is +5V, and the minimum amplitude is -5V.	

Syntax **SOURce[1|2]:FM:MODulation:INPut
{INTernal|EXTernal}**

Example **SOUR1:FM:MOD:INP EXT**
Sets the modulation source to external.

Query Syntax **SOURce[1|2]:FM:MODulation:INPut?**

Return Parameter	INT	Internal
	EXT	External

Example **SOUR1:FM:MOD:INP?**
INT
The modulation source is set to internal.

SOURce[1|2]:FM:INTernal:FUNction Source Specific Command

Description Sets the shape of the modulating waveform from sine, square, triangle, upramp and dn ramp for the selected channel. The default shape is sine.

Note Square and triangle waveforms have a 50% duty cycle. Upramp and dn ramp have a symmetry of 100% and 0%, respectively.

Syntax **SOURce[1|2]:FM:INTernal:FUNction
{SINusoid|SQUare|TRIangle|UPRamp|DNRamp}**

Example **SOUR1:FM:INT:FUNC SIN**
Sets the FM modulating wave shape to sine.

Query Syntax **SOURce[1|2]:FM:INTernal:FUNction?**

Return Parameter	SIN	Sine	UPRAMP	Upramp
	SQU	Square	DNRAMP	Dn ramp
	TRI	Triangle		

Example **SOUR1:FM:INT:FUNC?**
SIN
The shape for the modulating waveform is Sine.

SOURce[1 2]:FM:INTernal:FREQuency		Source Specific Command
Description	Sets the frequency of the internal modulating waveform only for the selected channel. The default frequency is 10Hz.	
Syntax	SOURce[1 2]:FM:INTernal:FREQuency {<frequency> MINimum MAXimum}	
Parameter	<frequency>	2mHz~ 20kHz
Example	SOUR1:FM:INT:FREQ +1.0000E+02 Sets the modulating frequency to 100Hz.	
Query Syntax	SOURce[1 2]:FM:INTernal:FREQuency? [MINimum MAXimum]	
Return Parameter	<NR3>	Returns the frequency in Hz.
Example	SOUR1:FM:INT:FREQ? MAX +2.0000E+04 Returns the maximum frequency allowed.	

SOURce[1 2]:FM:DEVIation		Source Specific Command
Description	Sets or queries the peak frequency deviation of the modulating waveform from the carrier waveform for the selected channel. The default peak deviation is 100Hz. The frequency deviation of external sources is controlled using the ±5V MOD INPUT terminal on the rear panel. A positive signal (>0~+5V) will increase the deviation (up to the set frequency deviation), whilst a negative voltage will reduce the deviation.	
Note	The relationship of peak deviation to modulating frequency and carrier frequency is shown below. Peak deviation = modulating frequency - carrier	

frequency.

The carrier frequency must be greater than or equal to the peak deviation frequency. The sum of the deviation and carrier frequency must not exceed the maximum frequency for a specific carrier shape. If an out of range deviation is set for any of the above conditions, the deviation will be automatically adjusted to the maximum value allowed and an “out of range” error will be generated.

For square wave carrier waveforms, the deviation may cause the duty cycle frequency boundary to be exceeded. In these conditions the duty cycle will be adjusted to the maximum allowed and a “settings conflict” error will be generated.

Syntax	SOURce[1 2]:FM:DEVIation {<peak deviation in Hz> MINimum MAXimum}	
Parameter	<peak deviation in Hz>	DC~30MHz (20MHz AFG-3021/3022) DC~1MHz (Ramp)
Example	SOUR1:FM:DEV MAX Sets the frequency deviation to the maximum value allowed.	
Query Syntax	SOURce[1 2]:FM:DEVIation? [MINimum MAXimum]	
Return Parameter	<NR3>	Returns the frequency deviation in Hz.
Example	SOURce1:FM:DEVIation? MAX +2.0000E+04 The maximum frequency deviation for the current function is 20MHz.	

Frequency-Shift Keying (FSK) Commands

FSK Overview

The following is an overview of the steps required to generate an FSK modulated waveform.

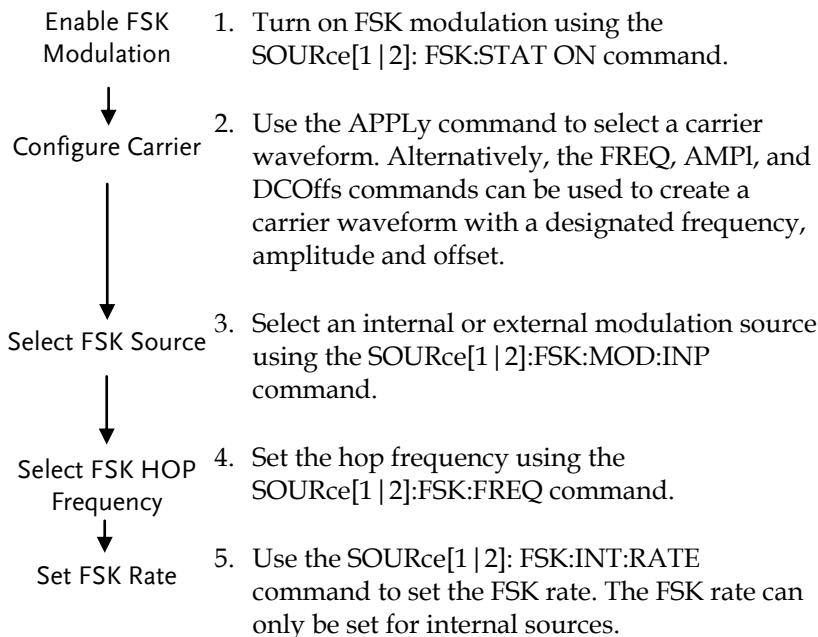

SOURce[1 2]:FSKey:STATE	Source Specific Command
Description	Turns FSK Modulation on or off for the selected channel. By default FSK modulation is off.
Note	Burst or sweep mode will be disabled if FSK modulation is enabled on the same channel. As only one modulation is allowed at any one time on the same channel, other modulation modes will be disabled when FSK modulation is enabled.

Syntax	SOURce[1 2]:FSKey:STATe {OFF ON}	
Example	SOUR1:FSK:STAT ON Enables FSK modulation	
Query Syntax	SOURce[1 2]:FSKey:STATe?	
Return Parameter	0	Disabled (OFF)
	1	Enabled (ON)
Example	SOUR1:FSK:STAT? ON FSK modulation is currently enabled.	

SOURce[1|2]:FSKey:MODulation:INPut Source Specific Command

Description	Sets or queries the FSK source as internal or external for the selected channel. Internal is the default source.	
Note	If an external FSK source is selected, FSK rate is controlled by the Trigger INPUT terminal on the rear panel.	
Syntax	SOURce[1 2]:FSKey:MODulation:INPut {INTernal EXTernal}	
Example	SOUR1:FSK:MOD:INP EXT Sets the FSK source to external.	
Query Syntax	SOURce[1 2]:FSKey:MOD:INP?	
Return Parameter	INT	Internal
	EXT	External
Example	SOUR1:FSK:MOD:INP? INT The FSK source is set to internal.	

SOURce[1 2]:FSKey:FREQuency		Source Specific Command
Description	Sets the FSK hop frequency. The default hop frequency is set to 100Hz.	
Note	For FSK, the modulating waveform is a square wave with a duty cycle of 50%.	
Syntax	SOURce[1 2]:FSKey:FREQuency {<frequency> MINimum MAXimum}	
Parameter	<frequency>	1μHz~30MHz (20MHZ AFG-3021/3022)
Example	SOUR1:FSK:FREQ +1.0000E+02 Sets the FSK hop frequency to 100Hz.	
Query Syntax	SOURce[1 2]:FSKey:FREQuency? [MINimum MAXimum]	
Return Parameter	<NR3>	Returns the frequency in Hz.
Example	SOUR1:FSK:FREQ? MAX +8.0000E+07 Returns the maximum hop frequency allowed.	

SOURce[1 2]:FSKey:INTernal:RATE		Source Specific Command
Description	Sets or queries the FSK rate for internal sources only.	
Note	External sources will ignore this command.	
Syntax	SOURce[1 2]:FSKey:INTernal:RATE {<rate in Hz> MINimum MAXimum}	
Parameter	<rate in Hz>	2 mHz~100 kHz
Example	SOUR1:FSK:INT:RATE MAX Sets the rate to the maximum (100kHz).	

Query Syntax	SOURce[1 2]:FSKey:INTernal:RATE? [MINimum MAXimum]	
Return Parameter	<NR3>	Returns the FSK rate in Hz.
Example	SOUR1:FSK:INT:RATE? MAX +1.0000E+05 Returns the maximum FSK rate allowed.	

Phase Modulation (PM) Commands

PM Overview

The following is an overview of the steps required to generate a PM waveform.

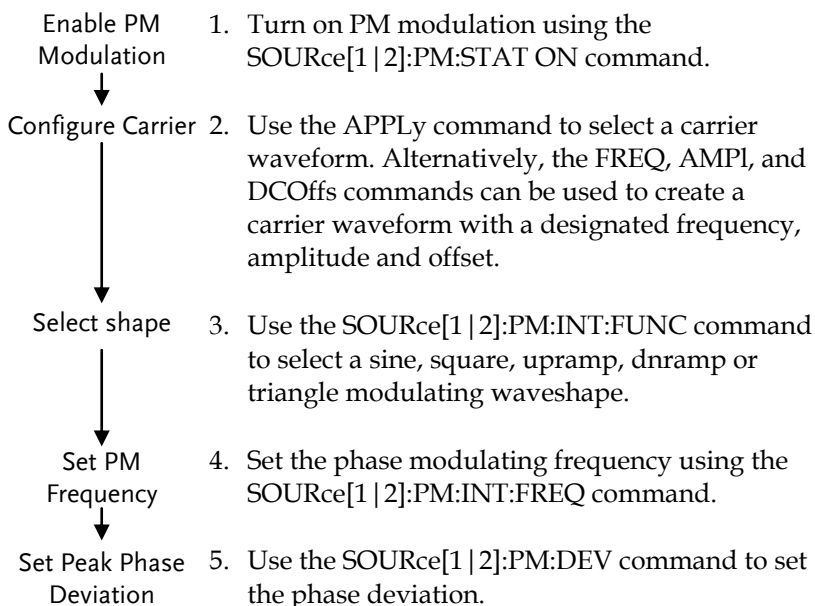

SOURce[1|2]:PM:STATe Source Specific Command

Description Sets or disables PM modulation for the selected channel. By default PM modulation is disabled. PM modulation must be enabled before setting other parameters.

Note Burst or sweep mode will be disabled if PM modulation is enabled on the same channel. As only one modulation is allowed at any one time on the same channel, other modulation modes will be disabled when PM modulation is enabled.

Syntax **SOUR[1|2]:PM:STATe {OFF|ON}**

Example **SOUR1:PM:STAT ON**
Enables PM modulation.

Query Syntax **SOURce[1|2]:PM:STATe?**

Return Parameter	0	Disabled (OFF)
	1	Enabled (ON)

Example **SOUR1:PM:STAT?**
1
PM modulation mode is currently enabled.

SOURce[1|2]:PM:INTernal:FUNCTion Source Specific Command

Description Sets the shape of the modulating waveform from sine, square, triangle, upramp and dnrramp for the selected channel. The default shape is sine.

Note Square and triangle waveforms have a 50% duty cycle. Upramp and dnrramp have a symmetry of 100% and 0%, respectively.

Syntax **SOURce[1|2]:PM:INTernal:FUNCTion {SINusoid|SQUare|TRIangle|UPRamp|DNRamp}**

Example **SOUR1:PM:INT:FUNC SIN**

Sets the PM modulating wave shape to sine.

Query Syntax	SOURce[1 2]:PM:INTernal:FUNction?			
Return Parameter	SIN	Sine	UPRAMP	Upramp
	SQU	Square	DNRAMP	Dnramp
	TRI	Triangle		

Example **SOUR1:PM:INT:FUNC?**
SIN
 The shape for the modulating waveform is Sine.

SOURce[1|2]:PM:INTernal:FREQuency Source Specific Command

Description Sets the phase modulation frequency for the selected channel. The default frequency is 100Hz.

Syntax **SOURce[1|2]:PM:INTernal:FREQuency**
{<frequency>|MINimum|MAXimum}

Parameter <frequency> 2mHz~ 20kHz

Example **SOUR1:PM:INT:FREQ +1.0000E+02**
 Sets the phase modulation frequency to 100Hz.

Query Syntax **SOURce[1|2]:PM:INTernal:FREQuency?**
[MINimum|MAXimum]

Return Parameter <NR3> Returns the frequency in Hz.

Example **SOUR1:PM:INT:FREQ? MAX**
+2.0000E+04
 Returns the maximum frequency allowed.

SOURce[1|2]:PM:DEVIation Source Specific Command

Description Sets or queries the peak phase deviation of the modulating waveform from the carrier waveform for the selected channel. The default peak deviation is 180.0°.

Syntax	SOURce[1 2]:PM:DEVIation {<peak deviation in degrees> MINimum MAXimum}	
Parameter	<peak deviation in degrees>	0° ~ 360°
Example	SOUR1:PM:DEV MAX Sets the phase deviation to 360°.	
Query Syntax	SOURce[1 2]:PM:DEVIation? [MINimum MAXimum]	
Return Parameter	<NR3>	Returns the phase deviation in degrees.
Example	SOURce1:PM:DEVIation? MAX +3.600E+02 The maximum phase deviation is 360°.	

Additive Modulation (SUM) Commands

SUM Overview

The following is an overview of the steps required to generate a SUM waveform.

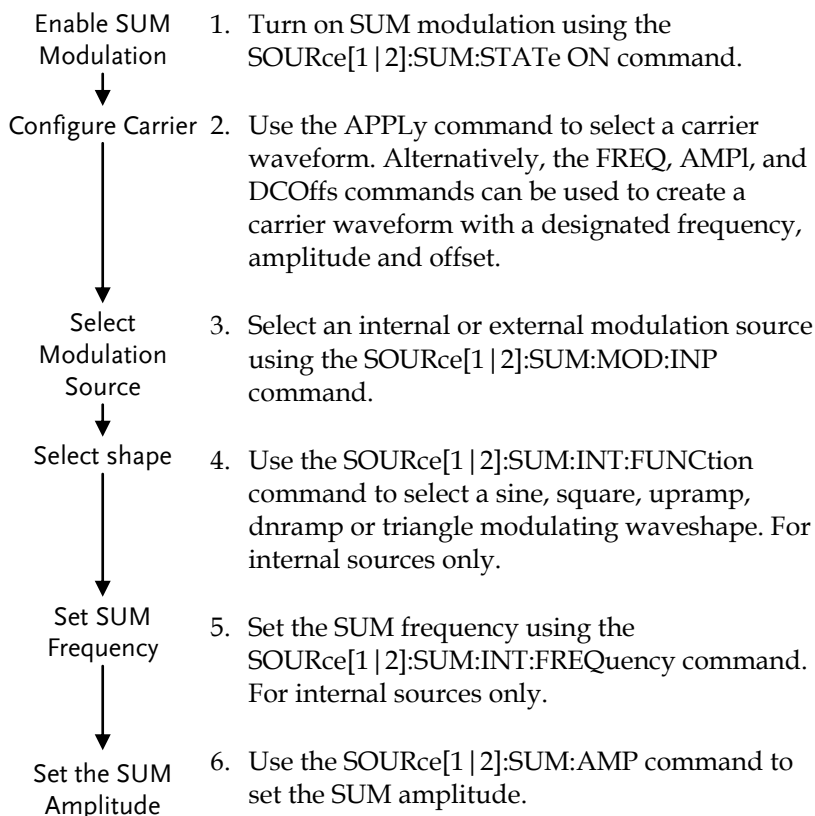

SOURce[1 2]:SUM:STATe		Source Specific Command
Description	Sets or disables SUM modulation for the selected channel. By default SUM modulation is disabled. SUM modulation must be enabled before setting other parameters.	
Note	Burst or sweep mode will be disabled if SUM modulation is enabled on the same channel. As only one modulation is allowed at any one time on the same channel, other modulation modes will be disabled when SUM modulation is enabled.	
Syntax	SOUR[1 2]:SUM:STATe {OFF ON}	
Example	SOUR1:SUM:STAT ON Enables SUM modulation.	
Query Syntax	SOURce[1 2]:SUM:STATe?	
Return Parameter	0	Disabled (OFF)
	1	Enabled (ON)
Example	SOUR1:SUM:STAT? 1 SUM modulation mode is currently enabled.	
SOURce[1 2]:SUM:MODulation:INPut		Source Specific Command

Description	Sets or queries the modulation source as internal or external for the selected channel. Internal is the default modulation source.	
Note	If an external modulation source is selected, the SUM amplitude is limited to $\pm 5V$ from the MOD INPUT terminal on the rear panel. For example, if SUM amplitude is set to 100%, then the maximum amplitude is +5V, and the minimum amplitude is -5V.	

Syntax	SOURce[1 2]:SUM:MODulation:INPut {INTernal EXTernal}		
Example	SOUR1:SUM:MOD:INP EXT Sets the modulation source to external.		
Query Syntax	SOURce[1 2]:SUM:MODulation:INPut?		
Return Parameter	INT	Internal	
	EXT	External	
Example	SOUR1:SUM:MOD:INP? INT The modulation source is set to internal.		

SOURce[1|2]:SUM:INTernal:FUNcTion Source Specific Command

Description	Sets the shape of the modulating waveform from sine, square, triangle, upramp and dn ramp for the selected channel. The default shape is sine.			
Note	Square and triangle waveforms have a 50% duty cycle. Upramp and dn ramp have a symmetry of 100% and 0%, respectively.			
Syntax	SOURce[1 2]:SUM:INTernal:FUNcTion {SINusoid SQUare TRIangle UPRamp DNRamp}			
Example	SOUR1:SUM:INT:FUNC SIN Sets the SUM modulating wave shape to sine.			
Query Syntax	SOURce[1 2]:SUM:INTernal:FUNcTion?			
Return Parameter	SIN	Sine	UPRAMP	Upramp
	SQU	Square	DNRAMP	Dn ramp
	TRI	Triangle		
Example	SOUR1:SUM:INT:FUNC? SIN The shape for the modulating waveform is Sine.			

SOURce[1 2]:SUM:INTernal:FREQUENCY		Source Specific Command
Description	Sets the frequency (SUM frequency) of the internal modulating waveform for the selected channel. The default frequency is 10Hz.	
Syntax	SOURce[1 2]:SUM:INTernal:FREQUENCY {<frequency> MINimum MAXimum}	
Parameter	<frequency>	2mHz~ 20kHz
Example	SOUR1:SUM:INT:FREQ +1.0000E+02 Sets the modulating frequency to 100Hz.	
Query Syntax	SOURce[1 2]:SUM:INTernal:FREQUENCY? [MINimum MAXimum]	
Return Parameter	<NR3>	Returns the frequency in Hz.
Example	SOUR1:SUM:INT:FREQ? MAX +2.0000E+04 Returns the maximum frequency allowed.	

SOURce[1 2]:SUM:AMPLitude		Source Specific Command
Description	The SUM amplitude command sets or queries the amplitude of the modulating waveform as a percentage of the carrier amplitude.	
Syntax	SOURce[1 2]:SUM:AMPLitude {<amplitude percent> MINimum MAXimum}	
Parameter	<amplitude percent>	0% ~ 100%
Example	SOUR1:SUM:AMPL MAX Sets the SUM amplitude to 100%.	
Query Syntax	SOURce[1 2]:SUM:AMPLitude?	
Return Parameter	<NR3>	Returns the amplitude in %.

Example

SOUR1:SUM:AMPL?

+1.0000E+02

The SUM amplitude is 100%.

Pulse Width Modulation (PWM) Commands

PWM Overview

The following is an overview of the steps required to generate a PWM modulated waveform.

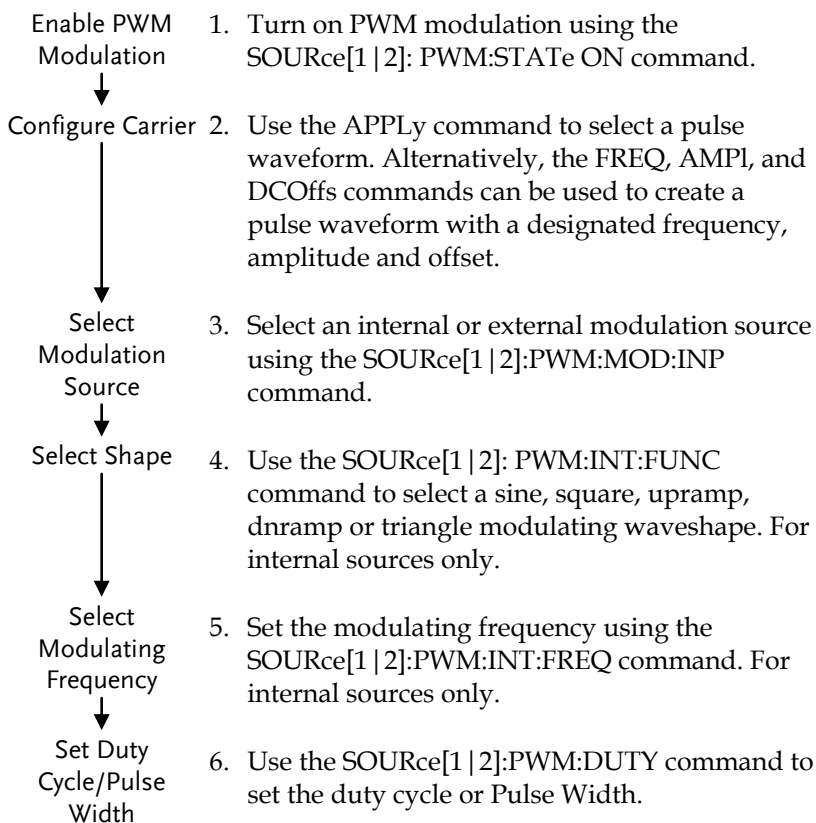

SOURce[1 2]:PWM:STATe		Source Specific Command
Description	Turns FSK Modulation on or off. By default FSK modulation is off.	
Note	Burst or sweep mode will be disabled if PWM modulation is enabled on the same channel. As only one modulation is allowed at any one time, other modulation modes will be disabled when FSK modulation is enabled on the same channel.	
Syntax	SOURce[1 2]:PWM:STATe {OFF ON}	
Example	SOUR1:PWM:STAT ON Enables PWM modulation	
Query Syntax	SOURce[1 2]:PWM:STATe?	
Return Parameter	0	Disabled (OFF)
	1	Enabled (ON)
Example	SOUR1:PWM:STAT? ON FSK modulation is currently enabled.	

SOURce[1 2]:PWM:MODulation:INPut		Source Specific Command
Description	Sets or queries the PWM source as internal or external. Internal is the default source.	
Note	If an external PWM source is selected, the duty cycle/pulse width is controlled by the MOD INPUT terminal on the rear panel.	
Syntax	SOURce[1 2]:PWM:MODulation:INPut {INTernal EXTernal}	
Example	SOUR1:PWM:MOD:INP EXT Sets the PWM source to external.	
Query Syntax	SOURce[1 2]:PWM:MODulation:INPut?	

Return Parameter	INT	Internal
	EXT	External

Example **SOUR1:PWM:MOD:INP?**
INT
 The PWM source is set to internal.

SOURce[1|2]:PWM:INTernal:FUNction Source Specific Command

Description Sets the shape of the modulating waveform from sine, square, triangle, upramp and dn ramp. The default shape is sine.

Note Square and triangle waveforms have a 50% duty cycle. Upramp and dn ramp have a symmetry to 100% and 0%, respectively.
 Carrier must be a pulse or PWM waveform.

Syntax **SOURce[1|2]:PWM:INTernal:FUNction**
{SINusoid|SQUare|TRIangle|UPRamp|DNRamp}

Example **SOUR1:PWM:INT:FUN SIN**
 Sets the PWM modulating wave shape to sine. .

Query Syntax **SOURce[1|2]:PWM:INTernal:FUNction?**

Return Parameter	SIN	Sine	UPRAMP	Upramp
	SQU	Square	DNRAMP	Dn ramp
	TRI	Triangle		

Example **SOUR1:PWM:INT:FUNCF**
SIN
 The shape for the modulating waveform is Sine.

SOURce[1|2]:PWM:INTernal:FREQUency Source Specific Command

Description Sets the modulating waveform frequency for internal sources. The default frequency is set to 10Hz.

Syntax	SOURce[1 2]:PWM:INTernal:FREQuency {<frequency> MINimum MAXimum}	
Parameter	<frequency>	2 mHz~ 20 kHz
Example	SOUR1:PWM:INT:FREQ MAX Sets the frequency to the maximum value.	
Query Syntax	SOURce[1 2]:PWM:INTernal:FREQuency?	
Return Parameter	<NR3>	Returns the frequency in Hz.
Example	SOUR1:PWM:INT:FREQ? MAX +2.0000E+04 Returns the modulating frequency. (20kHz)	

SOURce[1|2]:PWM:DUTY Source Specific Command

Description	Sets or queries the duty cycle deviation. The default duty cycle is 50%.	
Note	<p>The duty cycle is limited by period, edge time and minimum pulse width.</p> <p>The duty cycle deviation of an external source is controlled using the ±5V MOD INPUT terminal on the rear panel. A positive signal (>0~+5V) will increase the deviation (up to the set duty cycle deviation), whilst a negative voltage will reduce the deviation.</p>	
Syntax	SOURce[1 2]:PWM:DUTY {< percent> minimum maximum}	
Parameter	<percent>	0%~100% (limited, see above)
Example	SOUR1:PWM:DUTY +3.0000E+01 Sets the duty cycle to 30%.	
Query Syntax	SOURce[1 2]:PWM:DUTY?	
Return Parameter	<NR3>	Returns the dutyin %.

Example

SOUR1:PWM:DUTY?

+3.0000E+01

The current duty cycle is 30%.

Frequency Sweep Commands

Sweep Overview

Below shows the order in which commands must be executed to perform a sweep.

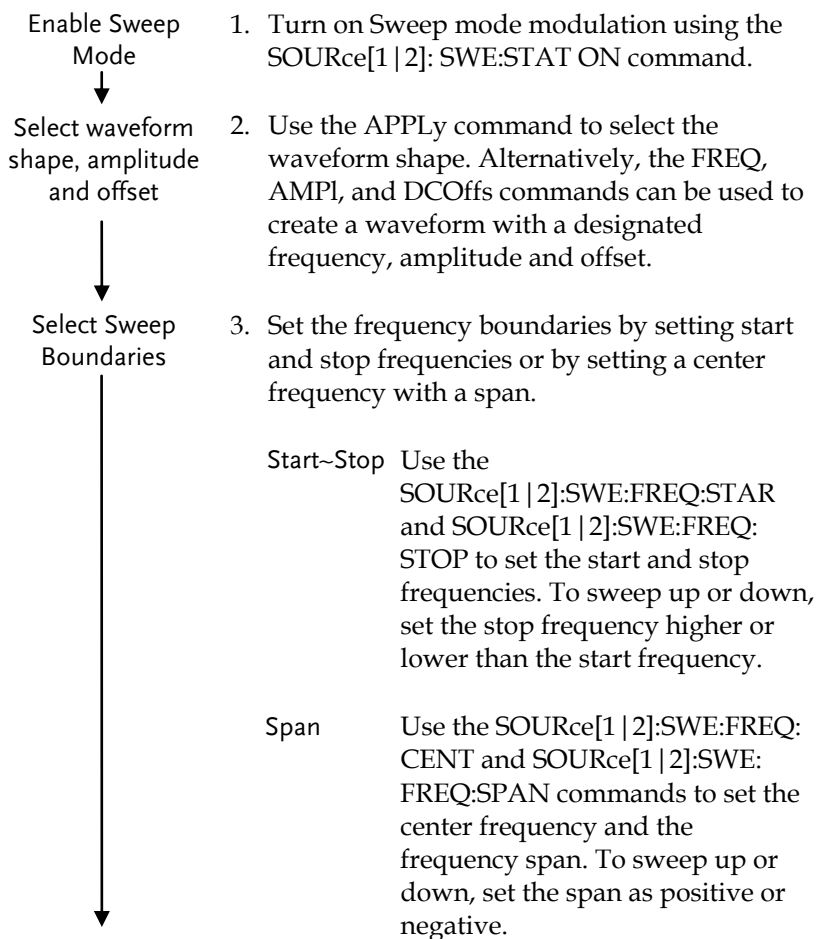

- | | |
|-------------------------------------------------------------------------------------|--------------------------------------------------------------------------------------------------------------------------------------------------------------------------------------------------------------------------------------------------------------------------------------------------------|
| Select Sweep Mode
↓
Select Sweep Time
↓
Select the sweep trigger source | 4. Choose Linear or Logarithmic spacing using the <code>SOURce[1 2]:SWE:FUNC</code> command.

5. Choose the sweep time using the <code>SOURce[1 2]:SWE:TIME</code> command.

6. Select an internal or external sweep trigger source using the <code>SOURce[1 2]:TRIG</code> command. |
|-------------------------------------------------------------------------------------|--------------------------------------------------------------------------------------------------------------------------------------------------------------------------------------------------------------------------------------------------------------------------------------------------------|

Source Specific Command

SOURce[1 | 2]:SWEep:STATe

Description	Sets or disables Sweep mode. By default Sweep is disabled.	
Note	Any modulation modes or Burst mode will be disabled if sweep mode is enabled on the same channel.	
Syntax	SOURce[1 2]:SWEep:STATe {OFF ON}	
Example	SOUR1:SWE:STAT ON Enables sweep mode.	
Query Syntax	SOURce[1 2]:SWEep:STATe?	
Return Parameter	0	Disabled (OFF)
	1	Enabled (ON)
Example	SOUR1:SWE:STAT? 1 Sweep mode is currently enabled.	

Source Specific Command

SOURce[1 | 2]:SWEep:TYPE

Description	Sets or queries the sweep type, frequency or amplitude sweep. By default, the sweep type is set to frequency.	
Syntax	SOURce[1 2]:SWEep:TYPE {FREQuency AMPLitude}	

Example **SOUR1:SWE:TYPE FREQ**
 Sets sweep mode to frequency.

Query Syntax **SOURce[1|2]:SWEep:TYPE?**

Return Parameter	FREQ	Frequency sweep
	AMPL	Amplitude sweep

Example **SOUR1:SWE:TYPE?**
FREQ
 Sweep type is frequency.

SOURce[1|2]:SWEep:MODE Source Specific Command

Description Sets or queries the sweep triggering mode. The triggering mode can be set to continuous or gate. By default, the triggering mode is set to continuous.

Syntax **SOURce[1|2]:SWEep:MODE {CONTInuous|GATE}**

Example **SOUR1:SWE:MODE GATE**
 Sets triggering mode to gate.

Query Syntax **SOURce[1|2]:SWEep:MODE?**

Return Parameter	CONT	Continuous mode
	GATE	Gated mode

Example **SOUR1:SWE:MODE?**
GATE
 The sweep trigger mode is set to gate.

SOURce[1|2]:SWEep:SHAPE Source Specific Command

Description Sets or queries the sweep waveform shape. The sweep can be set to a sawtooth or a shuttlecock-like shape. By default, the shape is set to sawtooth.

Syntax **SOURce[1|2]:SWEep:SHAPE{SAWtooth|TRIangle}**

Parameter	SAW TRI	Sawtooth shaped sweep Triangle (shuttle cock) shaped sweep.
-----------	------------	----------------------------------------------------------------

Example	SOUR1:SWE:SHAPE SAW Sets the sweep shape to sawtooth.	
---------	-----------------------------------------------------------------	--

Query Syntax	SOURce[1 2]:SWEep:SHAPE?	
--------------	---------------------------------	--

Return Parameter	sawtooth triangle	Sawtooth shaped sweep Triangle (shuttle cock) shaped sweep.
------------------	----------------------	----------------------------------------------------------------

Example	SOUR1:SWE:SHAPE? Sawtooth The sweep shape is set as sawtooth.	
---------	----------------------------------------------------------------------------	--

SOURce[1|2]:SWEep:MANual:TRIGger Source Specific Command

Description	Performs a manual trigger when the sweep trigger is set to manual for the selected channel.	
-------------	---------------------------------------------------------------------------------------------	--

Syntax	SOURce[1 2]:SWEep:MANual:TRIGger	
--------	-----------------------------------------	--

Example	SOUR1:SWE: MAN:TRIG Performs a manual trigger.	
---------	----------------------------------------------------------	--

SOURce[1|2]:SWEep:FREQuency:STARt Source Specific Command

Description	Sets the start frequency of the sweep for the selected channel. 100Hz is the default start frequency.	
-------------	-------------------------------------------------------------------------------------------------------	--

Note	To sweep up or down, set the stop frequency higher or lower than the start frequency.	
------	---------------------------------------------------------------------------------------	--

Syntax	SOURce[1 2]:SWEep:FREQuency:STARt {<frequency> MINimum MAXimum}	
--------	------------------------------------------------------------------------------	--

Parameter	<frequency>	1μHz~ 30MHz (20MHz AFG-3021/3022) 1μHz~ 1MHz (Ramp, Triangle)
Example	SOUR1:SWE:FREQ:STAR +2.0000E+03 Sets the start frequency to 2kHz.	
Query Syntax	SOURce[1 2]:SWEep:FREQuency:STAR? [MINimum MAXimum]	
Return Parameter	<NR3>	Returns the start frequency in Hz.
Example	SOUR1:SWE:FREQ:STAR? MAX +3.0000E+07 Returns the maximum start frequency allowed.	

SOURce[1|2]:SWEep:FREQuency:STOP Source Specific Command

Description	Sets the stop frequency of the sweep for the selected channel. 1 kHz is the default start frequency.	
Note	To sweep up or down, set the stop frequency higher or lower than the start frequency.	
Syntax	SOURce[1 2]:SWEep:FREQuency:STOP {<frequency> MINimum MAXimum}	
Parameter	<frequency>	1μHz~ 30MHz (20MHz AFG-3021/3022) 1μHz~ 1MHz (Ramp, Triangle)
Example	SOUR1:SWE:FREQ:STOP +2.0000E+03 Sets the stop frequency to 2kHz.	
Query Syntax	SOURce[1 2]:SWEep:FREQuency:STOP? [MINimum MAXimum]	
Return Parameter	<NR3>	Returns the stop frequency in Hz.

Example	SOUR1:SWE:FREQ:STOP? MAX +3.0000E+07	
	Returns the maximum stop frequency allowed.	
		Source Specific Command
SOURce[1 2]:SWEep:FREQuency:CENTer		
Description	Sets or queries the center frequency of the sweep for the selected channel. 550 Hz is the default center frequency.	
Note	The maximum center frequency depends on the sweep span and maximum frequency: $\text{max center freq} = \text{max freq} - \text{span}/2$	
Syntax	SOURce[1 2]:SWEep:FREQuency:CENTer {<frequency> MINimum MAXimum}	
Parameter	<frequency>	1μHz~ 30MHz (20MHz AFG-3021/3022) 1μHz~ 1MHz (Ramp)
Example	SOUR1:SWE:FREQ:CENT +2.0000E+03 Sets the center frequency to 2kHz.	
Query Syntax	SOURce[1 2]:SWEep:FREQuency:CENTer? [MINimum] MAXimum]	
Return Parameter	<NR3>	Returns the center frequency in Hz.
Example	SOUR1:SWE:FREQ:CENT? MAX +3.0000E+07 Returns the maximum center frequency allowed, depending on the span.	

SOURce[1|2]:SWEep:FREQuency:SPAN Source Specific Command

Description Sets or queries the frequency span of the sweep for the selected channel. 900 Hz is the default frequency span. The span frequency is equal to the stop-start frequencies.

Note To sweep up or down, set the span as positive or negative.
The maximum span frequency has a relationship to the center frequency and maximum frequency:
max freq span= 2(max freq - center freq)

Syntax **SOURce[1|2]:SWEep:FREQuency:SPAN {<frequency>|MINimum|MAXimum}**

Parameter	<frequency>	1μHz~ 30MHz (20MHz AFG-3021/3022) 1μHz~ 1MHz (Ramp)
------------------	--------------------------	---------------------------------------------------------------

Example **SOUR1:SWE:FREQ:SPAN +2.0000E+03**
Sets the frequency span to 2kHz.

Query Syntax **SOURce[1|2]:SWEep:FREQuency:SPAN? [MINimum|MAXimum]**

Return Parameter	<NR3>	Returns the frequency span in Hz.
-------------------------	--------------------	-----------------------------------

Example **SOUR1:SWE:FREQ:SPAN? +2.0000E+03**
Returns the frequency span for the current sweep.

SOURce[1|2]:SWEep:FUNction Source Specific Command

Description Sets linear or logarithmic sweep spacing. The default spacing is linear.

Syntax **SOURce[1|2]:SWEep:FUNction {LINear|LOG}**

Example	SOUR1:SWE:FUNC LIN Sets the spacing to linear.
Query Syntax	SOURce[1 2]:SWEep:FUNCTION?
Return Parameter	LIN Linear spacing
	LOG Logarithmic spacing
Example	SOUR1:SWE:FUNC? LOG The spacing is currently set as linear.

SOURce[1|2]:SWEep:TIME Source Specific Command

Description	Sets or queries the sweep time. The default sweep time is 1 second.
Note	The function generator automatically determines the number of frequency points that are used for the sweep based on the sweep time.
Syntax	SOURce[1 2]:SWEep:TIME {<seconds> MINimum MAXimum}
Parameter	<seconds> 1 ms ~ 500 s
Example	SOUR1:SWE:TIME +1.0000E+00 Sets the sweep time to 1 second.
Query Syntax	SOURce[1 2]:SWEep:TIME? {[MINimum MAXimum]}
Return Parameter	<NR3> Returns sweep time in seconds.
Example	SOUR1:SWE:TIME? +2.0000E+01 Returns the sweep time (20 seconds).

		Source Specific Command
SOURce[1 2]:SWEep:TRIGger		
Description	Sets or queries the trigger source as internal, external, manual or off for the selected channel. Internal is the default trigger source. INTERNAL will constantly output a swept waveform at a defined interval time. EXTERNAL will output a swept waveform after each external trigger pulse. Manual will output a swept waveform after the trigger softkey is pressed or the SOURce[1 2]:SWEep:MANual:TRIGger command is issued. The OFF setting is for continuous sweeping.	
Note	If the APPLy command was used to create the waveform shape, the source is automatically set to INTERNAL. The *OPC/*OPC? command/query can be used to signal the end of the sweep.	
Syntax	SOURce[1 2]:SWEep:TRIGger {EXTERNAL MANual OFF INTERNAL,<seconds> MINimum MAXimum}	
Parameter	INTERNAL	Internal trigger
	EXTERNAL	External trigger
	MANual	Manual trigger
	OFF	No interval time, sweep continuously
	<seconds>	1ms~ 500s. Interval time in seconds for the internal trigger.
	MINimum	Sets the interval time to the minimum
	MAXimum	Sets the interval time to the maximum
Example	SOUR1:SWE:TRIG EXT Sets the sweep source to external.	
Query Syntax	SOURce[1 2]:SWEep:TRIGger?	

Return Parameter	INT,<NR3>	Internal trigger, interval time in seconds
	EXT	External trigger
	MAN	Manual trigger
	OFF	Sweep continuously

Example **SOUR1:SWE:TRIG?**
INT +1.00000E+00

The sweep source is set to an interval time of 1 second.

SOURce[1|2]:SWEep:AMPLitude:STARt Source Specific Command

Description Sets the start amplitude for when the sweep is set to the amplitude sweep type. By default the start amplitude is set to 1Vpp.

Syntax **SOURce[1|2]:SWEep:AMPLitude:STARt**
{<ampiltude>|MINimum|MAXimum}

Parameter <NR3> Sweep amplitude in volts.
(range:1mV~10V @50Ω)

Example **SOUR1:SWE:AMPL:STAR MIN**

Sets the start sweep to the minimum level (1mVpp).

Query Syntax **SOURce[1|2]:SWEep:AMPLitude:STARt?**
{[MINimum|MAXimum]}

Return Parameter <NR3> Sweep amplitude in volts.

Example **SOUR1:SWE:AMPL:STAR?**
1.000E+00

The start amplitude is set to 1Vpp.

		Source Specific Command
SOURce[1 2]:SWEep:AMPLitude:STOP		
Description	Sets the stop amplitude for when the sweep is set to the amplitude sweep type. By default the stop amplitude is set to 3Vpp.	
Syntax	SOURce[1 2]:SWEep:AMPLitude:STOP {<amplitude> MINimum MAXimum}	
Parameter	<NR3>	Sweep amplitude in volts. (range:1mV~10V @50Ω)
Example	SOUR1:SWE:AMPL:STOP 3 Sets the stop sweep to 3Vpp).	
Query Syntax	SOURce[1 2]:SWEep:AMPLitude:STOP? {[MINimum MAXimum]}	
Return Parameter	<NR3>	Sweep amplitude in volts.
Example	SOUR1:SWE:AMPL:STOP? 3.000E+00 The stop amplitude is set to 3Vpp.	

Burst Mode Commands

Burst Mode Overview

Burst mode can be configured to use an internal trigger (N Cycle mode) or an external trigger (Gate mode) using the Trigger INPUT terminal on the rear panel. Using N Cycle mode, each time the function generator receives a trigger, the function generator will output a specified number of waveform cycles (burst). After the burst, the function generator will wait for the next trigger before outputting another burst. N Cycle is the default Burst mode.

The alternative to using a specified number of cycles, Gate mode uses the external trigger to turn on or off the output. When the Trigger INPUT signal is high*, waveforms are continuously output (creating a burst). When the Trigger INPUT signal goes low*, the waveforms will stop being output after the last waveform completes its period. The voltage level of the output will remain equal to the starting phase of the burst waveforms, ready for the signal to go high* again.

*assuming the Trigger polarity is not inverted.

Only one burst mode can be used at any one time. The burst mode depends on the source of the trigger (internal, external, manual) and the source of the burst.

Burst Mode & Source	Function		
	N Cycle*	Cycle	Phase
Triggered – IMMEDIATE	Available	Available	Available
Triggered - EXTERNAL, MANUAL	Available	Unused	Available
Gated pulse - IMMEDIATE	Unused	Unused	Available

*burst count

The following is an overview of the steps required to generate a burst waveform.

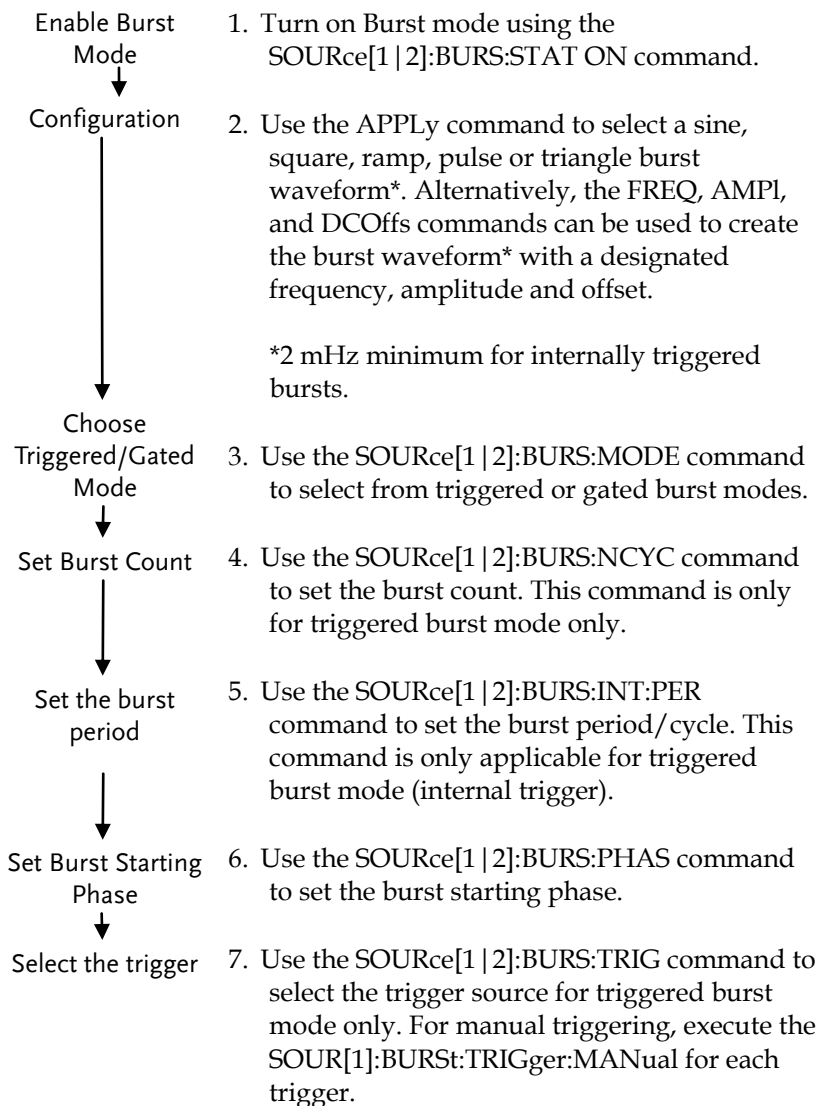

SOURce[1|2]:BURSt:STATe Source Specific Command

Description	Turns burst mode on or off for the selected channel. By default burst mode is turned off.	
Note	When burst mode is turned on, sweep and any modulation modes are disabled on the same channel.	
Syntax	SOURce[1 2]:BURSt:STATe {OFF ON}	
Parameter	OFF	Disabled
	ON	Enabled
Example	SOUR1:BURSt:STAT OFF Turns burst mode on.	
Query Syntax	SOURce[1 2]:BURSt:STATe?	
Return Parameter	0	Disabled
	1	Enabled
Example	SOUR1:BURSt:STAT? OFF Burst mode is off.	

SOURce[1|2]:BURSt:MODE Source Specific Command

Description	Sets or queries the burst mode as gated or triggered. The default burst mode is triggered.	
Note	The burst count, period, trigger source and any manual trigger commands are ignored in gated burst mode.	
Syntax	SOURce[1 2]:BURSt:MODE {TRIGGered GATE}	
Parameter	TRIGGered	Triggered mode
	GATE	Gated mode

Example	SOUR1:BURS:NCYCI INF	
	Sets the number of burst cycles to continuous (infinite).	
Query Syntax	SOURce[1 2]:BURSt:NCYCles? [MINimum MAXimum]	
Return Parameter	<NR3>	Returns the number of cycles.
	INF	INF is returned if the number of cycles is continuous.
Example	SOUR1:BURS:NCYC? +1.0000E+02	
	The burst cycles are set to 100.	

SOURce[1 2]:BURSt:INTernal:PERiod	Source Specific Command
------------------------------------------	-------------------------

Description	<p>Sets or queries the burst period for the selected channel. Burst period settings are only applicable when the trigger is set to immediate. The default burst period is 10ms.</p> <p>During manual triggering, external triggering or Gate burst mode, the burst period settings are ignored.</p>	
Note	<p>The burst period must be long enough to output the designated number of cycles for a selected frequency.</p> <p>Burst period > burst count / (waveform frequency + 200 ns)</p> <p>If the period is too short, it is automatically increased so that a burst can be continuously output. A "data out of range" error will also be generated.</p>	
Syntax	SOURce[1 2]:BURSt:INTernal:PERiod {<seconds> MINimum MAXimum}	
Parameter	<seconds >	1 us ~ 500 seconds

Example	SOUR1:BURS:INT:PER +1.0000E+01 Sets the period to 10 seconds.
Query Syntax	SOURce[1 2]:BURSt:INTernal:PERiod? [MINimum MAXimum]
Return Parameter	<NR3> Returns the burst period in seconds.
Example	SOUR1:BURS:INT:PER? +1.0000E+01 The burst period is 10 seconds.

SOURce[1|2]:BURSt:PHASe Source Specific Command

Description	Sets or queries the starting phase for the burst for the selected channel. The default phase is 0 degrees. At 0 degrees, sine, square and ramp waveforms are at 0 volts. In gated burst mode, waveforms are continuously output (burst) when the Trig signal is true. The voltage level at the starting phase is used to determine the voltage level of the signal in-between bursts.
Note	The phase command is not used with pulse waveforms.
Syntax	SOURce[1 2]:BURSt:PHASe {<angle> MINimum MAXimum}
Parameter	<angle> -360 ~ 360 degrees
Example	SOUR1:BURS:PHAS MAX Sets the phase to 360 degrees.
Query Syntax	SOURce[1 2]:BURSt:PHASe? [MINimum MAXimum]
Return Parameter	<NR3> Returns the phase angle in degrees.
Example	SOUR1:BURS:PHAS? +1.2000E+01 The burst starting phase is 120 degrees.

SOURce[1|2]:BURSt:TRIGger:MANual Source Specific Command

Description This command is used to manually trigger a burst waveform when the source trigger is set to manual for the selected channel. This command is the equivalent of pressing the trigger soft-key on the front panel for manual triggering.

Syntax **SOURce[1|2]:BURSt:TRIGger:MANual**

Example **SOUR1:BURS:TRIG:MAN**
 Manually triggers the burst waveform.

SOURce[1|2]:BURSt:TRIGger Source Specific Command

Description Sets or queries the trigger source for triggered burst mode for the selected channel. In triggered burst mode, a waveform burst is output each time a trigger signal is received and the number of cycles is determined by the burst count.

There are three trigger sources for triggered burst mode:

Immediate A burst is output at a set frequency determined by the burst period.

External EXternal will output a burst waveform after each external trigger pulse. Any additional trigger pulse signals before the end of the burst are ignored.

Manual Manual triggering will output a burst waveform after the SOUR[1]:BURSt:TRIGger:MANual command is executed or the trigger soft-key is pressed.

Note If the APPLy command was used, the source is automatically set to IMMEDIATE.
The *OPC/*OPC? command/query can be used to signal the end of the burst.

Syntax **SOURce[1|2]:BURSt:TRIGger {IMMEDIATE|EXTernal|MANual}**

Example **SOUR1:BURS:TRIG:SOUR EXT**
Sets the burst trigger source to external.

Query Syntax **SOURce[1|2]:BURSt:TRIGger?**

Return Parameter	IMM	Immediate
	EXT	External
	MANual	Manual

Example **SOUR1:BURS:TRIG? IMM**
The burst trigger source is set to immediate.

SOURce[1|2]:BURSt:TRIGger:DELay Source Specific Command

Description The DELay command is used to insert a delay (in seconds) before a burst is output for the selected channel. The delay starts after a trigger is received. The default delay is 0 seconds.

Syntax **SOURce[1|2]: BURSt:TRIGger:DELay {<seconds>|MINimum|MAXimum}**

Parameter <seconds> 0~100 seconds

Example **SOUR1:BURS:TRIG:DEL +1.0000E+01**
Sets the trigger delay to 10 seconds.

Query Syntax **SOURce[1|2]:BURSt:TRIGger:DELay? [MINimum|MAXimum]**

Return Parameter <NRf> Delay in seconds

Example **SOUR1:BURS:TRIG:DEL**
 +1.0000E+01
 The trigger delay is 10 seconds.

SOURce[1|2]:BURSt:TRIGger:SLOPe Source Specific Command

Description Sets or queries the trigger edge for externally triggered bursts from the Trigger INPUT terminal on the rear panel for the selected channel. By default the trigger is rising edge (Positive).

Syntax **SOURce[1|2]:BURSt:TRIGger:SLOPe**
 {POSitive|NEGative}

Parameter	POSitive	rising edge
	NEGative	falling edge

Example **SOUR1:BURS:TRIG:SLOP NEG**
 Sets the trigger slope to negative.

Query Syntax **SOURce[1|2]:BURSt:TRIGger:SLOPe?**

Return Parameter	POS	rising edge
	NEG	falling edge

Example **SOUR1:BURS:TRIG:SLOP**
 NEG
 The trigger slope is negative.

SOURce[1|2]:BURSt:GATE:POLarity Source Specific Command

Description In gated mode, for the selected channel, the function generator will output a waveform continuously while the external trigger receives logically true signal from the Trigger INPUT terminal. Normally a signal is logically true when it is high. The logical level can be inverted so that a low signal is considered true.

Syntax	SOURce[1 2]:BURSt:GATE:POLarity{NORMal INVertes}	
Parameter	NORMal	Logically high
	INVertes	Logically low
Example	SOUR1:BURS:GATE:POL INV Sets the state to logically low (inverted).	
Query Syntax	SOURce[1 2]:BURSt:GATE:POLarity?	
Return Parameter	NORM	Normal(High) logical level
	INV	Inverted (low) logical level
Example	SOUR1:BURS:GATE:POL? INV The true state is inverted(logically low).	

Arbitrary Waveform Commands

Arbitrary Waveform Overview

Use the steps below to output an arbitrary waveform over the remote interface.

- | | |
|-------------------------------------------------|------------------------------------------------------------------------------------------------------------------------------------------------------------------------------------------------------------------------|
| Output Arbitrary Waveform | 1. Use the SOURce[1 2]:ARB:BUILt:ARB_waveform command (Example: SOURce[1 2]:ARB:BUILt:SQUare) to output the arbitrary waveform currently selected in memory. |
| ↓ | |
| Select Waveform Frequency, amplitude and offset | 2. Use the APPLy command to select frequency, amplitude and DC offset. Alternatively, FREQ, FUNC, AMPL, and DCOffs commands can be used. |
| ↓ | |
| Load Waveform Data | 3. Waveform data (1 to 8388608 points per waveform) can be downloaded into volatile memory using the SOURce[1 2]:DATA:DAC command. Binary integer or decimal integer values in the range of ± 32767 can be used. |
| ↓ | |
| Set Waveform Rate | 4. The waveform rate is the product of the number of points in the waveform and the waveform frequency. |

$$\text{Rate} = \text{Hz} \times \# \text{ points}$$

Frequency: 1 μ Hz ~ 125MHz μ

points: 2 ~ 8,388,608

SOURce[1|2]:DATA:DAC Source Specific Command

Description The SOURce[1 | 2]:DATA:DAC command is used to download binary or decimal integer values into memory using the IEEE-488.2 binary block format or as an ordered list of values.

Note 1 The integer values (± 32767) correspond to the maximum and minimum peak amplitudes of the waveform. For instance, for a waveform with an amplitude of 5Vpp (0 offset), the value 32767 is the equivalent of 2.5 Volts. If the integer values do not span the full output range, the peak amplitude will be limited. The IEEE-488.2 binary block format is comprised of three parts:

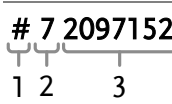
- | | |
|---------------------------------------------------------------------------------------------------------|--------------------------------------------------------------------------------------------------------------------------------------------------------------------------|
| # 7 2097152
 | <ol style="list-style-type: none"> 1. Initialization character (#) 2. Digit length (in ASCII) of the number of bytes 3. Number of bytes |
|---------------------------------------------------------------------------------------------------------|--------------------------------------------------------------------------------------------------------------------------------------------------------------------------|

IEEE 488.2 uses two bytes to represent waveform data (16 bit integer). Therefore the number of bytes is always twice the number of data points.

Note 2 The data sent by the command is limited to 1MB. To overcome the 1MB limitation, use the <start> parameter to send data segments of 1MB or less. Do not send the command before the last transmission has finished. An example will be shown below.

Syntax **SOURce[1|2]:DATA:DAC VOLATILE, <start>, {<binary block>|<value>, <value>, ... }**

Parameter	<start> <binary block> <value>	Start address of the arbitrary waveform Decimal or integer values ± 32767
------------------	----------------------------------------------	------------------------------------------------------------------------------------------

Example1 **SOUR1:DATA:DAC VOLATILE, 0, #216 Binary Data**
 The command above downloads 8 data values (stored in 16 bytes) using the binary block format.
SOUR1:DATA:DAC VOLATILE, 1000, 32767, 2048, 0, -2048, -32767
 Downloads the data values (32767, 2048, 0, -2048, -32767) to address 1000.

Example2a
 (0~1M data points)

SOUR1:DATA:DAC VOLATILE,0,#72097152 Binary Data
 This command will send that first 0~1M data points to address 0. To send data to the next 1M data points, see below:

Example2b
 (1M~2M data points)

SOUR1:DATA:DAC VOLATILE,1048576,#72097152 Binary Data
 This command will send the next 1M data points (1M~2M)

SOURce[1|2]:ARB:EDIT:COPY Source Specific Command

Description Copies a segment of a waveform to a specific starting address.

Syntax **SOURce[1|2]:ARB:EDIT:COPY**
[<start>,<length>,<paste>]]]

Parameter	<start>	Start address: 0~8388606
	<length>	Length: 2~8388608
	<paste>	Paste address: 0~8388607

Example **SOUR1:ARB:EDIT:COPY 1000, 256, 1257**
 Copies 256 data values starting at address 1000 and copies them to address 1257.

SOURce[1 2]:ARB:EDIT:DELeTe		Source Specific Command
Description	Deletes a segment of a waveform from memory for the selected channel. The segment is defined by a starting address and length.	
Note	A waveform/ waveform segment cannot be deleted when being output.	
Syntax	SOURce[1 2]:ARB:EDIT:DELeTe [<START>[,<LENGTh>]]	
Parameter	<START>	Start address: 0~8388606
	<LENGTh>	Length: 2~8388608
Example	SOURce1:ARB:EDIT:DEL 1000, 256 Deletes a section of 256 data points from the waveform starting at address 1000.	

SOURce[1 2]:ARB:EDIT:DELeTe:ALL		Source Specific Command
Description	Deletes all user-defined waveforms from non-volatile memory and the current waveform in volatile memory for the selected channel.	
Note	A waveform cannot be deleted when output.	
Syntax	SOURce[1 2]:ARB:EDIT:DELeTe:ALL	
Example	SOUR1:ARB:EDIT:DEL:ALL Deletes all user waveforms from memory.	

SOURce[1 2]:ARB:EDIT:POINt		Source Specific Command
Description	Edit a point on the arbitrary waveform.	
Note	A waveform/ waveform segment cannot be deleted when being output.	
Syntax	SOURce[1 2]:ARB:EDIT:POINt [<address> [, <data>]]	

Parameter	<address>	Address of data point: 0~8388607
	<data>	Value data: ± 32,767

Example **SOUR1:ARB:EDIT:POIN 1000, 32767**
 Creates a point on the arbitrary waveform at address 1000 with the highest amplitude.

SOURce[1|2]:ARB:EDIT:PROTECT Source Specific Command

Description Protects a segment of the arbitrary waveform from deletion/editing or returns the protection state and co-ordinates (if any).

Syntax **SOURce[1|2]:ARB:EDIT:PROTECT**
[<START>[,<LENGTH>]]

Parameter	<START>	Start address: 0~8388606
	<LENGTH>	Length: 2~8388608

Example **SOUR1:ARB:EDIT:PROT 40, 50**
 Protects a segment of the waveform from address 40 for 50 data points.

Query Syntax **SOURce[1|2]:ARB:EDIT:PROTECT?**

Return Parameter	“UnProtect”	Returns the string “Unprotect” when protection is disabled.
	“Protect Start:”<START> Protect Length:”<LENGTH>	Returns a string showing the start of the protection and the protection length.

Example **SOUR1:ARB:EDIT:PROT?**
Protect Start:0 Protect Length:10
 Returns the protected segment of the ARB waveform.

SOURce[1|2]:ARB:EDIT:PROTect:ALL Source Specific Command

Description Protects the arbitrary waveform currently in non-volatile memory/ currently being output.

Syntax **SOURce[1|2]:ARB:EDIT:PROTect:ALL**

Example **SOUR1:ARB:EDIT:PROT:ALL**

SOURce[1|2]:ARB:EDIT:UNProtect Source Specific Command

Description Unprotects the arbitrary waveform currently in non-volatile memory/ currently being output.

Syntax **SOURce[1|2]:ARB:EDIT:UNProtect**

Example **SOUR1:ARB:EDIT:UNP**

SOURce[1|2]:ARB:BUILt:SINusoid Source Specific Command

Description Creates a sinusoid with a specified start address, length and scale for the selected channel.

Syntax **SOURce[1|2]:ARB:BUILt:SINusoid [<START>[,<LENGth>[,<SCALe>]]]**

Parameter	<START>	Start address*: 0~8388606
	<LENGth>	Length*: 2~8388608
	<SCALe>	Scale: ±32767

* Start + Length ≤ 8388608

Example **SOUR1:ARB:BUIL:SIN 1000, 1000, 100**

Creates a sin wave 1000 points in length with a scale of 100 and a start address of 1000.

SOURce[1|2]:ARB:BUILt:SQUare Source Specific Command

Description Creates a square wave with a specified start address, length and scale.

Syntax **SOURce[1|2]:ARB:BUILt:SQUare**
[<START>,<LENGth>,<SCALE>]]]

Parameter	<START>	Start address*: 0~8388606
	<LENGth>	Length*: 2~8388608
	<SCALE>	Scale: ±32767

* Start + Length ≤ 8388608

Example **SOUR1:ARB:BUIL:SQU 1000, 1000, 100**
 Creates a square wave 1000 points in length with a scale of 100 and a start address of 1000.

Source Specific
Command

SOURce[1|2]:ARB:BUILt:PULSe

Description Creates a pulse wave with a specified frequency and duty.

Syntax **SOURce[1|2]:ARB:BUILt:PULSe**
{{<frequency>|MINimum|MAXimum},{<percent>|MINimum|MAXimum}}]

Parameter	<frequency>	Sets the pulse frequency
	<percent>	Sets the duty of the pulse as a percentage

*Frequency	Resolution	Duty Resolution
1pHz~5Hz	1pHz	0.0001%
>5Hz~50Hz	1uHz	0.0001%
>50Hz~500Hz	10uHz	0.001%
>500Hz~5kHz	100uHz	0.01%
>5kHz~50kHz	1mHz	0.1%
>50kHz~500kHz	10mHz	1%

Example **SOUR1:ARB:BUIL:PULSe +1.00000002E+03, +1.002E+01**
 Creates a 1000.0002 Hz pulse wave with a 10.02% duty cycle.

SOURce[1 2]:ARB:BUILt:RAMP		Source Specific Command
Description	Creates a ramp wave with a specified start address, length and scale for the selected channel.	
Syntax	SOURce[1]:ARB:BUILt:RAMP[<START>[,<LENGth>[,<SCALe>]]]	
Parameter	<START> <LENGth> <SCALe>	Start address*: 0~8388606 Length*: 2~8388608 Scale: ±32767
	* Start + Length ≤ 8388608	
Example	SOUR1:ARB:BUIL:RAMP 1000, 1000, 100 Creates a ramp wave 1000 points in length with a scale of 100 and a start address of 1000.	

SOURce[1 2]:ARB:BUILt:SINC		Source Specific Command
Description	Creates a sinc wave with a specified start address, length and scale.	
Syntax	SOURce[1 2]:ARB:BUILt:SINC [<START>[,<LENGth>[,<SCALe>]]]	
Parameter	<START> <LENGth> <SCALe>	Start address*: 0~8388606 Length*: 2~8388608 Scale: ±32767
	* Start + Length ≤ 8388608	
Example	SOUR1:ARB:BUIL:SINC 1000, 1000, 100 Creates a sinc wave 1000 points in length with a scale of 100 and a start address of 1000.	

SOURce[1 2]:ARB:BUILt:EXPRise		Source Specific Command
Description	Creates an exponential rise wave with a specified start address, length and scale for the selected channel.	
Syntax	SOURce[1 2]:ARB:BUILt:EXPRise [<START>[,<LENGth>[,<SCALe>]]]	
Parameter	<STARt> <LENGth> <SCALe>	Start address*: 0~8388606 Length*: 2~8388608 Scale: ± 32767 * Start + Length \leq 8388608
Example	SOUR1:ARB:BUIL:EXPR 1000, 1000, 100 Creates an exponential rise wave 1000 points in length with a scale of 100 and a start address of 1000.	
SOURce[1 2]:ARB:BUILt:EXPFall		Source Specific Command
Description	Creates an exponential fall wave with a specified start address, length and scale.	
Syntax	SOURce[1 2]:ARB:BUILt:EXPFall [<START>[,<LENGth>[,<SCALe>]]]	
Parameter	<STARt> <LENGth> <SCALe>	Start address*: 0~8388606 Length*: 2~8388608 Scale: ± 32767 * Start + Length \leq 8388608
Example	SOUR1:ARB:BUIL:EXPF 1000, 1000, 100 Creates an exponential fall wave 1000 points in length with a scale of 100 and a start address of 1000.	

		Source Specific Command
SOURce[1 2]:ARB:BUILt:DC		
Description	Creates a DC waveform with a specified start address, length and scale.	
Syntax	SOURce[1 2]:ARB:BUILt:DC [<START>[,<LENGth>[,<Data>]]]	
Parameter	<START>	Start address*: 0~8388606
	<LENGth>	Length*: 2~8388608
	<Data>	Data: ±32767
	* Start + Length ≤ 8388608	
Example	SOUR1:ARB:BUIL:DC 1000, 1000, 100 Creates a DC waveform of 1000 points in length with a data of 100 and a start address of 1000.	

		Source Specific Command
SOURce[1 2]:ARB:BUILt:stair_ud		
Description	Creates an up & down staircase waveform(8 steps up, 8 steps down).	
Syntax	SOURce[1 2]:ARB:BUILt:stair_ud [<START>[,<LENGth>[,<SCALE>]]]	
Parameter	<START>	Start address*: 0~8388606
	<LENGth>	Length*: 2~8388608
	<SCALE>	Scale: ±32767
	* Start + Length ≤ 8388608	
Example	SOUR1:ARB:BUIL:stair_ud 1000, 1000, 100 Creates an up & down staircase waveform 1000 points in length with a scale of 100 and a start address of 1000.	

SOURce[1|2]:ARB:BUILt:stair_down Source Specific Command

Description Creates an 8-step down-staircase waveform.

Syntax **SOURce[1|2]:ARB:BUILt:stair_down**
[<START>,<LENGth>,<SCALE>]]]

Parameter	<START>	Start address*: 0~8388606
	<LENGth>	Length*: 2~8388608
	<SCALE>	Scale: ±32767

* Start + Length ≤ 8388608

Example **SOUR1:ARB:BUIL:stair_down 1000, 1000, 100**
 Creates a staircase waveform 1000 points in length with a scale of 100 and a start address of 1000.

SOURce[1|2]:ARB:BUILt:stair_up Source Specific Command

Description Creates an 8-step up-staircase waveform.

Syntax **SOURce[1|2]:ARB:BUILt:stair_up**
[<START>,<LENGth>,<SCALE>]]]

Parameter	<START>	Start address*: 0~8388606
	<LENGth>	Length*: 2~8388608
	<SCALE>	Scale: ±32767

* Start + Length ≤ 8388608

Example **SOUR1:ARB:BUIL:stair_up 1000, 1000, 100**
 Creates a staircase waveform 1000 points in length with a scale of 100 and a start address of 1000.

SOURce[1|2]:ARB:BUILt:absatan Source Specific Command

Description Creates an absolute atan waveform.

Syntax **SOURce[1|2]:ARB:BUILt:absatan**
[<START>,<LENGth>,<SCALE>]]]

Parameter	<START>	Start address*: 0~8388606
	<LENGth>	Length*: 2~8388608
	<SCALe>	Scale: ± 32767
* Start + Length \leq 8388608		

Example **SOUR1:ARB:BUIL:absatan 1000, 1000, 100**
 Creates an absolute atan waveform 1000 points in length with a scale of 100 and a start address of 1000.

SOURce[1|2]:ARB:BUILt:abssin Source Specific Command

Description Creates an absolute sine waveform.

Syntax **SOURce[1|2]:ARB:BUILt:abssin**
[<START>[,<LENGth>[,<SCALe>]]]

Parameter	<START>	Start address*: 0~8388606
	<LENGth>	Length*: 2~8388608
	<SCALe>	Scale: ± 32767
* Start + Length \leq 8388608		

Example **SOUR1:ARB:BUIL:abssin 1000, 1000, 100**
 Creates an absolute sine waveform 1000 points in length with a scale of 100 and a start address of 1000.

SOURce[1|2]:ARB:BUILt:abssinehalf Source Specific Command

Description Creates an absolute half sine waveform.

Syntax **SOURce[1|2]:ARB:BUILt:abssinehalf**
[<START>[,<LENGth>[,<SCALe>]]]

Parameter	<START>	Start address*: 0~8388606
	<LENGth>	Length*: 2~8388608
	<SCALe>	Scale: ± 32767
* Start + Length \leq 8388608		

SOURce[1|2]:ARB:BUILt:diric_even Source Specific Command

Description	Creates an even Dirichlet kernel waveform.	
Syntax	SOURce[1 2]:ARB:BUILt:diric_even [<START>[,<LENGth>[,<SCALE>]]]	
Parameter	<START>	Start address*: 0~8388606
	<LENGth>	Length*: 2~8388608
	<SCALE>	Scale: ±32767
* Start + Length ≤ 8388608		
Example	SOUR1:ARB:BUIL:diric_even 1000, 1000, 100 Creates an even diric waveform 1000 points in length with a scale of 100 and a start address of 1000.	

SOURce[1|2]:ARB:BUILt:diric_odd Source Specific Command

Description	Creates an odd diric waveform.	
Syntax	SOURce[1 2]:ARB:BUILt:diric_odd [<START>[,<LENGth>[,<SCALE>]]]	
Parameter	<START>	Start address*: 0~8388606
	<LENGth>	Length*: 2~8388608
	<SCALE>	Scale: ±32767
* Start + Length ≤ 8388608		
Example	SOUR1:ARB:BUIL:diric_odd 1000, 1000, 100 Creates an odd Diric waveform 1000 points in length with a scale of 100 and a start address of 1000.	

SOURce[1|2]:ARB:BUILt:gauspuls Source Specific Command

Description Creates a Gaussian-modulated sinusoidal pulse waveform.

Syntax **SOURce[1|2]:ARB:BUILt:gauspuls**
[<START>[,<LENGth>[,<SCALE>]]]

Parameter	<START>	Start address*: 0~8388606
	<LENGth>	Length*: 2~8388608
	<SCALE>	Scale: ±32767

* Start + Length ≤ 8388608

Example **SOUR1:ARB:BUIL:gauspuls 1000, 1000, 100**
 Creates a Gaussian-pulse waveform 1000 points in length with a scale of 100 and a start address of 1000.

SOURce[1|2]:ARB:BUILt:havercosine Source Specific Command

Description Creates a havercosine waveform.

Syntax **SOURce[1|2]:ARB:BUILt:havercosine[<START>[,<LENGth>[,<SCALE>]]]**

Parameter	<START>	Start address*: 0~8388606
	<LENGth>	Length*: 2~8388608
	<SCALE>	Scale: ±32767

* Start + Length ≤ 8388608

Example **SOUR1:ARB:BUIL:havercosine 1000, 1000, 100**
 Creates a havercosine waveform 1000 points in length with a scale of 100 and a start address of 1000.

SOURce[1|2]:ARB:BUILt:haversine Source Specific Command

Description Creates a haversine waveform.

Syntax **SOURce[1|2]:ARB:BUILt:haversine[<START>[,<LENGth>[,<SCALE>]]]**

Parameter	<START>	Start address*: 0~8388606
	<LENGth>	Length*: 2~8388608
	<SCALE>	Scale: ±32767

* Start + Length ≤ 8388608

Example **SOUR1:ARB:BUIL:haversin 1000, 1000, 100**
 Creates a haversine waveform 1000 points in length with a scale of 100 and a start address of 1000.

SOURce[1|2]:ARB:BUILt:n_pulse Source Specific Command

Description Creates a negative pulse waveform.

Syntax **SOURce[1|2]:ARB:BUILt:n_pulse[<START>[,<LENGth>[,<SCALE>]]]**

Parameter	<START>	Start address*: 0~8388606
	<LENGth>	Length*: 2~8388608
	<SCALE>	Scale: ±32767

* Start + Length ≤ 8388608

Example **SOUR1:ARB:BUIL:n_pulse 1000, 1000, 100**
 Creates a negative pulse waveform 1000 points in length with a scale of 100 and a start address of 1000.

SOURce[1|2]:ARB:BUILt:negramp Source Specific Command

Description Creates a negative ramp pulse waveform.

Syntax	SOURce[1 2]:ARB:BUILt:negramp [<START>,<LENGth>,<SCALe>]]]	
Parameter	<START>	Start address*: 0~8388606
	<LENGth>	Length*: 2~8388608
	<SCALe>	Scale: ± 32767
* Start + Length \leq 8388608		
Example	SOUR1:ARB:BUILt:negramp 1000, 1000, 100 Creates a negative ramp waveform 1000 points in length with a scale of 100 and a start address of 1000.	

SOURce[1|2]:ARB:BUILt:rectpuls Source Specific Command

Description	Creates a rectangular pulse.	
Syntax	SOURce[1 2]:ARB:BUILt:rectpuls [<START>,<LENGth>,<SCALe>]]]	
Parameter	<START>	Start address*: 0~8388606
	<LENGth>	Length*: 2~8388608
	<SCALe>	Scale: ± 32767
* Start + Length \leq 8388608		
Example	SOUR1:ARB:BUILt:rectpuls 1000, 1000, 100 Creates a rectangular pulse waveform 1000 points in length with a scale of 100 and a start address of 1000.	

SOURce[1|2]:ARB:BUILt:roundhalf Source Specific Command

Description	Creates a positive half circle ($y=\sqrt{1-x^2}$).	
Syntax	SOURce[1 2]:ARB:BUILt:roundhalf [<START>,<LENGth>,<SCALe>]]]	

Parameter	<START> <LENGth> <SCALe>	Start address*: 0~8388606 Length*: 2~8388608 Scale: ±32767
* Start + Length ≤ 8388608		

Example **SOUR1:ARB:BUIL:roundhalf 1000, 1000, 100**
 Creates a positive half circle waveform 1000 points in length with a scale of 100 and a start address of 1000.

SOURce[1|2]:ARB:BUILt:sawtoot Source Specific Command

Description Creates a sawtooth waveform.

Syntax **SOURce[1|2]:ARB:BUILt:sawtoot**
[<START>[,<LENGth>[,<SCALe>]]]

Parameter	<START> <LENGth> <SCALe>	Start address*: 0~8388606 Length*: 2~8388608 Scale: ±32767
* Start + Length ≤ 8388608		

Example **SOUR1:ARB:BUIL:sawtoot 1000, 1000, 100**
 Creates a sawtooth waveform 1000 points in length with a scale of 100 and a start address of 1000.

SOURce[1|2]:ARB:BUILt:sinetra Source Specific Command

Description Creates a piecewise sine wave.

Syntax **SOURce[1|2]:ARB:BUILt:sinetra**
[<START>[,<LENGth>[,<SCALe>]]]

Parameter	<START> <LENGth> <SCALe>	Start address*: 0~8388606 Length*: 2~8388608 Scale: ±32767
* Start + Length ≤ 8388608		

Example **SOUR1:ARB:BUIL:sinetra 1000, 1000, 100**
 Creates a piecewise sine waveform 1000 points in length with a scale of 100 and a start address of 1000.

SOURce[1|2]:ARB:BUILt:stepresp Source Specific Command

Description Creates a Heaviside step function(step response).

Syntax **SOURce[1|2]:ARB:BUILt:stepresp**
[<START>,<LENGth>,<SCALE>]]]

Parameter	<START>	Start address*: 0~8388606
	<LENGth>	Length*: 2~8388608
	<SCALE>	Scale: ±32767
* Start + Length ≤ 8388608		

Example **SOUR1:ARB:BUIL:stepresp 1000, 1000, 100**
 Creates a Heaviside sine waveform 1000 points in length with a scale of 100 and a start address of 1000.

SOURce[1|2]:ARB:BUILt:sinever Source Specific Command

Description Creates piecewise sine wave (clipped to 0 at 0° to 90° and 180° to 270°).

Syntax **SOURce[1|2]:ARB:BUILt:sinever**
[<START>,<LENGth>,<SCALE>]]]

Parameter	<START>	Start address*: 0~8388606
	<LENGth>	Length*: 2~8388608
	<SCALE>	Scale: ±32767
* Start + Length ≤ 8388608		

Example **SOUR1:ARB:BUIL:sinever 1000, 1000, 100**

Creates a piecewise sine wave waveform 1000 points in length with a scale of 100 and a start address of 1000.

SOURce[1|2]:ARB:BUILt:trapezia Source Specific Command

Description Creates a trapezoid waveform.

Syntax **SOURce[1|2]:ARB:BUILt:trapezia**
[<START>[,<LENGth>[,<SCALE>]]]

Parameter	<START>	Start address*: 0~8388606
	<LENGth>	Length*: 2~8388608
	<SCALE>	Scale: ±32767

* Start + Length ≤ 8388608

Example **SOUR1:ARB:BUIL:trapezia 1000, 1000, 100**

Creates trapezoid waveform 1000 points in length with a scale of 100 and a start address of 1000.

SOURce[1|2]:ARB:BUILt:tripuls Source Specific Command

Description Creates a triangular pulse waveform.

Syntax **SOURce[1|2]:ARB:BUILt:tripuls**
[<START>[,<LENGth>[,<SCALE>]]]

Parameter	<START>	Start address*: 0~8388606
	<LENGth>	Length*: 2~8388608
	<SCALE>	Scale: ±32767

* Start + Length ≤ 8388608

Example **SOUR1:ARB:BUIL:tripuls 1000, 1000, 100**

Creates triangular pulse waveform 1000 points in length with a scale of 100 and a start address of 1000.

SOURce[1|2]:ARB:BUILt:dlorentz Source Specific Command

Description Creates a derivative of the Lorentz function waveform.

Syntax **SOURce[1|2]:ARB:BUILt:dlorentz**
[<START>[,<LENGth>[,<SCALE>]]]

Parameter	<START>	Start address*: 0~8388606
	<LENGth>	Length*: 2~8388608
	<SCALE>	Scale: ±32767

* Start + Length ≤ 8388608

Example **SOUR1:ARB:BUIL:dlorentz 1000, 1000, 100**

Creates a derivative of Lorentz function waveform 1000 points in length with a scale of 100 and a start address of 1000.

SOURce[1|2]:ARB:BUILt:gauss Source Specific Command

Description Creates a gauss bell curve waveform.

Syntax **SOURce[1|2]:ARB:BUILt:gauss**
[<START>[,<LENGth>[,<SCALE>]]]

Parameter	<START>	Start address*: 0~8388606
	<LENGth>	Length*: 2~8388608
	<SCALE>	Scale: ±32767

* Start + Length ≤ 8388608

Example **SOUR1:ARB:BUIL:gauss 1000, 1000, 100**

Creates a gauss bell curve waveform 1000 points in length with a scale of 100 and a start address of 1000.

SOURce[1 2]:ARB:BUILt:ln		Source Specific Command
<hr/>		
Description	Creates natural logarithm waveform.	
Syntax	SOURce[1 2]:ARB:BUILt:ln [<START>,<LENGth>,<SCALe>]]]	
Parameter	<START>	Start address*: 0~8388606
	<LENGth>	Length*: 2~8388608
	<SCALe>	Scale: ±32767
	* Start + Length ≤ 8388608	
Example	SOUR1:ARB:BUIL:ln 1000, 1000, 100 Creates a natural logarithm waveform 1000 points in length with a scale of 100 and a start address of 1000.	

SOURce[1 2]:ARB:BUILt:lorentz		Source Specific Command
<hr/>		
Description	Creates a Lorentz function waveform.	
Syntax	SOURce[1 2]:ARB:BUILt:lorentz [<START>,<LENGth>,<SCALe>]]]	
Parameter	<START>	Start address*: 0~8388606
	<LENGth>	Length*: 2~8388608
	<SCALe>	Scale: ±32767
	* Start + Length ≤ 8388608	
Example	SOUR1:ARB:BUIL:lorentz 1000, 1000, 100 Creates a Lorentz function waveform 1000 points in length with a scale of 100 and a start address of 1000.	

SOURce[1|2]:ARB:BUILt:sinc Source Specific Command

Description	Creates a cardinal sine function waveform.	
Syntax	SOURce[1 2]:ARB:BUILt:sinc [<START>,<LENGth>,<SCALe>]]]	
Parameter	<START>	Start address*: 0~8388606
	<LENGth>	Length*: 2~8388608
	<SCALe>	Scale: ±32767
	* Start + Length ≤ 8388608	
Example	SOUR1:ARB:BUIL:sinc 1000, 1000, 100 Creates a cardinal sine function waveform 1000 points in length with a scale of 100 and a start address of 1000.	

SOURce[1|2]:ARB:BUILt:sqrt Source Specific Command

Description	Creates a square root function waveform.	
Syntax	SOURce[1 2]:ARB:BUILt:sqrt [<START>,<LENGth>,<SCALe>]]]	
Parameter	<START>	Start address*: 0~8388606
	<LENGth>	Length*: 2~8388608
	<SCALe>	Scale: ±32767
	* Start + Length ≤ 8388608	
Example	SOUR1:ARB:BUIL:sqrt 1000, 1000, 100 Creates a square root function waveform 1000 points in length with a scale of 100 and a start address of 1000.	

SOURce[1 2]:ARB:BUILt:xsquare		Source Specific Command
<hr/>		
Description	Creates a quadratic (x^2) function waveform.	
Syntax	SOURce[1 2]:ARB:BUILt:xsquare [<START>,<LENGth>,<SCALE>]]]	
Parameter	<START>	Start address*: 0~8388606
	<LENGth>	Length*: 2~8388608
	<SCALE>	Scale: ± 32767
* Start + Length \leq 8388608		
Example	SOUR1:ARB:BUIL:xsquare 1000, 1000, 100 Creates a quadratic function waveform 1000 points in length with a scale of 100 and a start address of 1000.	

SOURce[1 2]:ARB:BUILt:arccos		Source Specific Command
<hr/>		
Description	Creates an inverse cosine function waveform.	
Syntax	SOURce[1 2]:ARB:BUILt:arccos [<START>,<LENGth>,<SCALE>]]]	
Parameter	<START>	Start address*: 0~8388606
	<LENGth>	Length*: 2~8388608
	<SCALE>	Scale: ± 32767
* Start + Length \leq 8388608		
Example	SOUR1:ARB:BUIL:arccos 1000, 1000, 100 Creates an inverse cosine function waveform 1000 points in length with a scale of 100 and a start address of 1000.	

SOURce[1 2]:ARB:BUILt:arccot		Source Specific Command
Description	Creates an inverse cotangent function waveform.	
Syntax	SOURce[1 2]:ARB:BUILt:arccot [<START>,<LENGth>,<SCALe>]]]	
Parameter	<START>	Start address*: 0~8388606
	<LENGth>	Length*: 2~8388608
	<SCALe>	Scale: ±32767
	* Start + Length ≤ 8388608	
Example	SOUR1:ARB:BUIL:arccot 1000, 1000, 100 Creates an inverse cotangent function waveform 1000 points in length with a scale of 100 and a start address of 1000.	

SOURce[1 2]:ARB:BUILt:arccsc		Source Specific Command
Description	Creates an inverse cosecant function waveform.	
Syntax	SOURce[1 2]:ARB:BUILt:arccsc [<START>,<LENGth>,<SCALe>]]]	
Parameter	<START>	Start address*: 0~8388606
	<LENGth>	Length*: 2~8388608
	<SCALe>	Scale: ±32767
	* Start + Length ≤ 8388608	
Example	SOUR1:ARB:BUIL:arccsc 1000, 1000, 100 Creates an inverse cosecant function waveform 1000 points in length with a scale of 100 and a start address of 1000.	

SOURce[1|2]:ARB:BUILt:arcsec Source Specific Command

Description	Creates an inverse secant function waveform.	
Syntax	SOURce[1 2]:ARB:BUILt:arccsc [<START>[,<LENGth>[,<SCALE>]]]	
Parameter	<START>	Start address*: 0~8388606
	<LENGth>	Length*: 2~8388608
	<SCALE>	Scale: ±32767
* Start + Length ≤ 8388608		
Example	SOUR1:ARB:BUIL:arccsc 1000, 1000, 100 Creates an inverse secant function waveform 1000 points in length with a scale of 100 and a start address of 1000.	

SOURce[1|2]:ARB:BUILt:arcsin Source Specific Command

Description	Creates an inverse sine waveform.	
Syntax	SOURce[1 2]:ARB:BUILt:arcsin [<START>[,<LENGth>[,<SCALE>]]]	
Parameter	<START>	Start address*: 0~8388606
	<LENGth>	Length*: 2~8388608
	<SCALE>	Scale: ±32767
* Start + Length ≤ 8388608		
Example	SOUR1:ARB:BUIL:arcsin 1000, 1000, 100 Creates an inverse sine waveform 1000 points in length with a scale of 100 and a start address of 1000.	

SOURce[1|2]:ARB:BUILt:arcsinh Source Specific Command

Description Creates an inverse hyperbolic sine waveform.

Syntax **SOURce[1|2]:ARB:BUILt:arcsinh**
[<START>,<LENGth>,<SCALE>]]]

Parameter

<START>	Start address*: 0~8388606
<LENGth>	Length*: 2~8388608
<SCALE>	Scale: ±32767

* Start + Length ≤ 8388608

Example **SOUR1:ARB:BUIL:arcsinh 1000, 1000, 100**
 Creates an inverse hyperbolic sine waveform 1000 points in length with a scale of 100 and a start address of 1000.

SOURce[1|2]:ARB:BUILt:arctan Source Specific Command

Description Creates an inverse tangent waveform.

Syntax **SOURce[1|2]:ARB:BUILt:arctan**
[<START>,<LENGth>,<SCALE>]]]

Parameter

<START>	Start address*: 0~8388606
<LENGth>	Length*: 2~8388608
<SCALE>	Scale: ±32767

* Start + Length ≤ 8388608

Example **SOUR1:ARB:BUIL:arctan 1000, 1000, 100**
 Creates an inverse tangent waveform 1000 points in length with a scale of 100 and a start address of 1000.

SOURce[1 2]:ARB:BUILt:arctanh		Source Specific Command
<hr/>		
Description	Creates an inverse hyperbolic tangent waveform.	
Syntax	SOURce[1 2]:ARB:BUILt:arctanh [<START>,<LENGth>,<SCALe>]]]	
Parameter	<START>	Start address*: 0~8388606
	<LENGth>	Length*: 2~8388608
	<SCALe>	Scale: ±32767
* Start + Length ≤ 8388608		
Example	SOUR1:ARB:BUIL:arctanh 1000, 1000, 100 Creates an inverse hyperbolic tangent waveform 1000 points in length with a scale of 100 and a start address of 1000.	

SOURce[1 2]:ARB:BUILt:cosh		Source Specific Command
<hr/>		
Description	Creates a hyperbolic cosine waveform.	
Syntax	SOURce[1 2]:ARB:BUILt:cosh [<START>,<LENGth>,<SCALe>]]]	
Parameter	<START>	Start address*: 0~8388606
	<LENGth>	Length*: 2~8388608
	<SCALe>	Scale: ±32767
* Start + Length ≤ 8388608		
Example	SOUR1:ARB:BUIL:cosh 1000, 1000, 100 Creates a hyperbolic cosine waveform 1000 points in length with a scale of 100 and a start address of 1000.	

SOURce[1 2]:ARB:BUILt:cot		Source Specific Command
Description	Creates a cotangent waveform.	
Syntax	SOURce[1 2]:ARB:BUILt:cot [<START>,<LENGth>,<SCALe>]]]	
Parameter	<START>	Start address*: 0~8388606
	<LENGth>	Length*: 2~8388608
	<SCALe>	Scale: ±32767
	* Start + Length ≤ 8388608	
Example	SOUR1:ARB:BUIL:cot 1000, 1000, 100 Creates a cotangent waveform 1000 points in length with a scale of 100 and a start address of 1000.	

SOURce[1 2]:ARB:BUILt:csc		Source Specific Command
Description	Creates a cosecant waveform.	
Syntax	SOURce[1 2]:ARB:BUILt:csc [<START>,<LENGth>,<SCALe>]]]	
Parameter	<START>	Start address*: 0~8388606
	<LENGth>	Length*: 2~8388608
	<SCALe>	Scale: ±32767
	* Start + Length ≤ 8388608	
Example	SOUR1:ARB:BUIL:csc 1000, 1000, 100 Creates a cosecant waveform 1000 points in length with a scale of 100 and a start address of 1000.	

SOURce[1 2]:ARB:BUILt:sec		Source Specific Command
<hr/>		
Description	Creates a secant waveform.	
Syntax	SOURce[1 2]:ARB:BUILt:sec [<START>,<LENGth>,<SCALE>]]]	
Parameter	<START>	Start address*: 0~8388606
	<LENGth>	Length*: 2~8388608
	<SCALE>	Scale: ±32767
	* Start + Length ≤ 8388608	
Example	SOUR1:ARB:BUIL:sec 1000, 1000, 100 Creates a secant waveform 1000 points in length with a scale of 100 and a start address of 1000.	

SOURce[1 2]:ARB:BUILt:sech		Source Specific Command
<hr/>		
Description	Creates a hyperbolic secant waveform.	
Syntax	SOURce[1 2]:ARB:BUILt:sech [<START>,<LENGth>,<SCALE>]]]	
Parameter	<START>	Start address*: 0~8388606
	<LENGth>	Length*: 2~8388608
	<SCALE>	Scale: ±32767
	* Start + Length ≤ 8388608	
Example	SOUR1:ARB:BUIL:sech 1000, 1000, 100 Creates a hyperbolic secant waveform 1000 points in length with a scale of 100 and a start address of 1000.	

SOURce[1|2]:ARB:BUILt:sinh Source Specific Command

Description Creates a hyperbolic sine waveform.

Syntax **SOURce[1|2]:ARB:BUILt:sinh**
[<START>,<LENGth>,<SCALe>]]]

Parameter	<START>	Start address*: 0~8388606
	<LENGth>	Length*: 2~8388608
	<SCALe>	Scale: ±32767
* Start + Length ≤ 8388608		

Example **SOUR1:ARB:BUILt:sinh 1000, 1000, 100**
 Creates a hyperbolic sine waveform 1000 points in length with a scale of 100 and a start address of 1000.

SOURce[1|2]:ARB:BUILt:tan Source Specific Command

Description Creates a tangent waveform.

Syntax **SOURce[1|2]:ARB:BUILt:tan**
[<START>,<LENGth>,<SCALe>]]]

Parameter	<START>	Start address*: 0~8388606
	<LENGth>	Length*: 2~8388608
	<SCALe>	Scale: ±32767
* Start + Length ≤ 8388608		

Example **SOUR1:ARB:BUILt:tan 1000, 1000, 100**
 Creates a tangent waveform 1000 points in length with a scale of 100 and a start address of 1000.

SOURce[1 2]:ARB:BUILt:tanh		Source Specific Command
Description	Creates a hyperbolic tangent waveform.	
Syntax	SOURce[1 2]:ARB:BUILt:tanh [<START>,<LENGth>,<SCALE>]]]	
Parameter	<START>	Start address*: 0~8388606
	<LENGth>	Length*: 2~8388608
	<SCALE>	Scale: ±32767
* Start + Length ≤ 8388608		
Example	SOUR1:ARB:BUIL:tanh 1000, 1000, 100 Creates a hyperbolic tangent waveform 1000 points in length with a scale of 100 and a start address of 1000.	

SOURce[1 2]:ARB:BUILt:barthannwin		Source Specific Command
Description	Creates a Bartlett-Hann window function waveform.	
Syntax	SOURce[1 2]:ARB:BUILt:barthannwin [<START>,<LENGth>,<SCALE>]]]	
Parameter	<START>	Start address*: 0~8388606
	<LENGth>	Length*: 2~8388608
	<SCALE>	Scale: ±32767
* Start + Length ≤ 8388608		
Example	SOUR1:ARB:BUIL:barthannwin 1000, 1000, 100 Creates a Bartlett-Hann window function waveform 1000 points in length with a scale of 100 and a start address of 1000.	

SOURce[1|2]:ARB:BUILt:bartlett Source Specific Command

Description Creates a Bartlett window function waveform.

Syntax **SOURce[1|2]:ARB:BUILt:bartlett**
[<START>,<LENGth>,<SCALe>]]]

Parameter	<START>	Start address*: 0~8388606
	<LENGth>	Length*: 2~8388608
	<SCALe>	Scale: ±32767

* Start + Length ≤ 8388608

Example **SOUR1:ARB:BUIL:bartlett 1000, 1000, 100**

Creates a Bartlett window function waveform 1000 points in length with a scale of 100 and a start address of 1000.

SOURce[1|2]:ARB:BUILt:blackman Source Specific Command

Description Creates a Blackman window function waveform.

Syntax **SOURce[1|2]:ARB:BUILt:blackman**
[<START>,<LENGth>,<SCALe>]]]

Parameter	<START>	Start address*: 0~8388606
	<LENGth>	Length*: 2~8388608
	<SCALe>	Scale: ±32767

* Start + Length ≤ 8388608

Example **SOUR1:ARB:BUIL:blackman 1000, 1000, 100**

Creates a Blackman window function waveform 1000 points in length with a scale of 100 and a start address of 1000.

SOURce[1 2]:ARB:BUILt:bohmanwin		Source Specific Command
Description	Creates a Bohmanwin window function waveform.	
Syntax	SOURce[1 2]:ARB:BUILt:bohmanwin [<START>[,<LENGth>[,<SCALE>]]]	
Parameter	<START>	Start address*: 0~8388606
	<LENGth>	Length*: 2~8388608
	<SCALE>	Scale: ±32767
	* Start + Length ≤ 8388608	
Example	SOUR1:ARB:BUIL:bohmanwin 1000, 1000, 100 Creates a Bohmanwin window function waveform 1000 points in length with a scale of 100 and a start address of 1000.	

SOURce[1 2]:ARB:BUILt:chebwin		Source Specific Command
Description	Creates a Chebyshev window function waveform.	
Syntax	SOURce[1 2]:ARB:BUILt:chebwin [<START>[,<LENGth>[,<SCALE>]]]	
Parameter	<START>	Start address*: 0~8388606
	<LENGth>	Length*: 2~8388608
	<SCALE>	Scale: ±32767
	* Start + Length ≤ 8388608	
Example	SOUR1:ARB:BUIL:chebwin 1000, 1000, 100 Creates a Chebyshev window function waveform 1000 points in length with a scale of 100 and a start address of 1000.	

SOURce[1 2]:ARB:BUILt:flattopwin		Source Specific Command
Description	Creates a flat top weighted window function waveform.	
Syntax	SOURce[1 2]:ARB:BUILt:chebwin [<START>[,<LENGth>[,<SCALE>]]]	
Parameter	<START>	Start address*: 0~8388606
	<LENGth>	Length*: 2~8388608
	<SCALE>	Scale: ±32767
	* Start + Length ≤ 8388608	
Example	SOUR1:ARB:BUIL:chebwin 1000, 1000, 100 Creates a flat top weighted window function waveform 1000 points in length with a scale of 100 and a start address of 1000.	
SOURce[1 2]:ARB:BUILt:hamming		Source Specific Command
Description	Creates a Hamming window function waveform.	
Syntax	SOURce[1 2]:ARB:BUILt:hamming [<START>[,<LENGth>[,<SCALE>]]]	
Parameter	<START>	Start address*: 0~8388606
	<LENGth>	Length*: 2~8388608
	<SCALE>	Scale: ±32767
	* Start + Length ≤ 8388608	
Example	SOUR1:ARB:BUIL:hamming 1000, 1000, 100 Creates a Hamming window function waveform 1000 points in length with a scale of 100 and a start address of 1000.	

SOURce[1|2]:ARB:BUILt:hann Source Specific Command

Description	Creates a Hann window function waveform.	
Syntax	SOURce[1 2]:ARB:BUILt:hann [<START>[,<LENGth>[,<SCALE>]]]	
Parameter	<START>	Start address*: 0~8388606
	<LENGth>	Length*: 2~8388608
	<SCALE>	Scale: ±32767
* Start + Length ≤ 8388608		
Example	SOUR1:ARB:BUIL:hann 1000, 1000, 100 Creates a Hann window function waveform 1000 points in length with a scale of 100 and a start address of 1000.	

SOURce[1|2]:ARB:BUILt:kaiser Source Specific Command

Description	Creates a Kasier window function waveform.	
Syntax	SOURce[1 2]:ARB:BUILt:kaiser [<START>[,<LENGth>[,<SCALE>]]]	
Parameter	<START>	Start address*: 0~8388606
	<LENGth>	Length*: 2~8388608
	<SCALE>	Scale: ±32767
* Start + Length ≤ 8388608		
Example	SOUR1:ARB:BUIL:kaiser 1000, 1000, 100 Creates a Kaiser window function waveform 1000 points in length with a scale of 100 and a start address of 1000.	

SOURce[1 2]:ARB:BUILt:traing		Source Specific Command
Description	Creates a Triangle window function waveform.	
Syntax	SOURce[1 2]:ARB:BUILt:traing [<START>,<LENGth>,<SCALe>]]]	
Parameter	<START>	Start address*: 0~8388606
	<LENGth>	Length*: 2~8388608
	<SCALe>	Scale: ±32767
	* Start + Length ≤ 8388608	
Example	SOUR1:ARB:BUILt:traing 1000, 1000, 100 Creates a Triangle window function waveform 1000 points in length with a scale of 100 and a start address of 1000.	

SOURce[1 2]:ARB:BUILt:tukeywin		Source Specific Command
Description	Creates a Tukey window function waveform.	
Syntax	SOURce[1 2]:ARB:BUILt:tukey [<START>,<LENGth>,<SCALe>]]]	
Parameter	<START>	Start address*: 0~8388606
	<LENGth>	Length*: 2~8388608
	<SCALe>	Scale: ±32767
	* Start + Length ≤ 8388608	
Example	SOUR1:ARB:BUILt:tukey 1000, 1000, 100 Creates a Tukey window function waveform 1000 points in length with a scale of 100 and a start address of 1000.	

SOURce[1|2]:ARB:OUTPut Source Specific Command

Description	Marks a section of the ARB waveform to be output.	
Syntax	SOURce[1 2]:ARB:OUTPut [<START>[,<LENGth>]]	
Parameter	<START>	Start address*: 0~8388606
	<LENGth>	Length*: 2~8388608
Example	SOUR1:ARB:OUTP 100, 1000 Sets the ARB output section from point 100 to 1100.	
Query Syntax	SOUR1:ARB:OUTP?	
Return Parameter	Returns the following string:	
	Start:<START>,Length:<LENGth>	
	<START>	0~8388606
	<LENGth>	2~8388608
Example	SOUR1:ARB:OUTP? 0, 1024 The output section starts at 0 and ends at 1024.	

SOURce[1|2]:ARB:RATE Source Specific Command

Description	Sets or queries the sample rate of the ARB waveform.	
Syntax	SOURce[1 2]:ARB:RATE {<frequency> MINimum MAXimum}	
Parameter	<frequency>	Sets the sample rate frequency in Hz.
	MINimum	1μ Hz
	MAXimum	250MHz
Example	SOUR1:ARB:RATE 20000 Sets the ARB rate to 20kHz.	
Query Syntax	SOUR1:ARB:RATE?	

Return Parameter <NRf> Returns the rate in Hz.

Example **SOUR1:ARB:RATE?**
+2.000000000000E+04
 The rate is 20 kHz.

SOURce[1|2]:ARB:GATE Source Specific Command

Description Sets or queries whether a high or low level TTL signal applied to the trigger input turns the output on or off when the ARB output trigger is in the Gated mode (for the selected channel).
 Using this command will set the ARB output trigger as Gate Pos or Gate Neg and disable the Ncycle or Infinite trigger settings.

Syntax **SOURce[1|2]:ARB:GATE {POSitive|NEGative}**

Parameter	POSitive	Gated output when a high TTL level signal is applied.
	NEGative	Gated output when a low TTL level signal is applied.

Example **SOUR1:ARB:GATE POS**
 Configures the CH1 ARB waveform to be output when a positive TTL signal is applied to the CH1 trigger input.

Query Syntax **SOURce[1|2]:ARB:GATE?**

Return Parameter	OFF	Indicates that the trigger is in Ncycle mode.
	POSitive	Trigger gate polarity is negative.
	NEGative	Trigger gate polarity is positive.

Example **SOURce1:ARB:GATE?**
OFF
 The ARB output trigger is in Ncycle mode.

SOURce[1|2]:ARB:NCYCles Source Specific Command

Description	Sets how the ARB Ncycle mode is triggered	
Syntax	SOURce[1 2]:ARB:NCYCles {INFinite MANual EXTernal}	
Parameter	INFinite	Continuous cycles
	MANual	Manual trigger
	EXTernal	External trigger
Example	SOUR1:ARB:NCYC INF Sets the number of ARB waveform output cycles to continuous (infinite).	
Query Syntax	SOURce[1 2]:ARB:NCYCles?	
Return Parameter	OFF	ARB output trigger is in the Gate mode.
	INF	Continuous cycles
	MAN	Manual trigger
	EXT	External trigger
Example	SOUR1:ARB:NCYC? INF The ARB waveform output is set to infinite.	

SOURce[1|2]:ARB:NCYCles:CYCle Source Specific Command

Description	The arbitrary waveform output can be repeated for a designated number of cycles.	
Syntax	SOURce[1 2]:ARB:NCYCles:CYCle {<cycles> MINimum MAXimum}	
Parameter	<cycles>	1 ~ 8388607 cycles
	MINimum	Minimum number of cycles (1)
	MAXimum	Maximum number of cycles (8388607)

Example **SOUR1:ARB:NCYC:CYC MAX**
 Sets the number of ARB waveform output cycles to the maximum.

Query Syntax **SOURce[1|2]:ARB:NCYCles:CYCle?**
{[MINimum|MAXimum]}

Return Parameter <NR3> Number of Ncycles.

Example **SOUR1:ARB:NCYC:CYC?**
+8.388607E+06
 Sets the number of ncycles to 8388607.

SOURce[1|2]:ARB:MANual:TRIGger Source Specific Command

Description This command is used to manually trigger the ARB output for the selected channel. This command is the equivalent of pressing the trigger soft-key on the front panel for manual triggering.

Syntax **SOURce[1|2]:ARB:MANual:TRIGger**

Example **SOUR1:ARB:MAN:TRIG**
 Manually triggers the ARB waveform.

Tracking Commands

SOURce[1 2]:COUPlE:FREQuency:MODE		Source Specific Command
Description	Sets the frequency coupling mode for the AFG-3022 and AFG-3032 models. By default, frequency coupling is turned off.	
Syntax	SOURce[1 2]:COUPlE:FREQuency:MODE {OFF OFFSet RATio}	
Parameter	OFF	Coupling off, independent output
	OFFSet	Holds the frequency difference at a constant offset value
	RATio	Holds the frequency ratio between each channel to constant ratio.
Example	SOUR1:COUP:FREQ:MODE OFF Turns frequency coupling off.	
Query Syntax	SOURce[1 2]:COUPlE:FREQuency:MODE	
Return Parameter	OFF	Coupling off, independent output
	OFFS	Set to constant offset value
	RAT	Set to constant ratio value.
Example	SOUR1:COUP:FREQ:MODE? OFF Indicates that frequency coupling is turned off.	

SOURce[1|2]:COUPle:FREQuency:OFFSet Source Specific Command

Description	<p>Sets the frequency coupling offset value. The default value is 0Hz. Applicable for the AFG-3022 and 3032 only.</p> <p>Note: CH2 frequency = CH1 frequency + offset frequency. CH1 frequency is fixed regardless of whether the SOURce1 or SOURce2 command is used.</p>	
Syntax	SOURce[1 2]:COUPle:FREQuency:OFFSet {<frequency> MINimum MAXimum}	
Parameter	<frequency>	<p>Frequency difference in hertz.</p> <p>Range: -30MHz ~ 30MHz (20MHz AFG-3022)</p> <p>Resolution: 1uHz</p>
	MINimum	Sets the frequency to the minimum.
	MAXimum	Sets the frequency to the maximum.
Example	<p>SOUR1:COUP:FREQ:OFFS 1000</p> <p>Sets the frequency coupling to 1kHz.</p>	
Query Syntax	SOURce[1 2]:COUPle:FREQuency:OFFSet {[MINimum MAXimum]}	
Return Parameter	<NR3>	Offset frequency.
Example	<p>SOUR1:COUP:FREQ:OFFS?</p> <p>+1.000E+03</p> <p>Indicates that the frequency coupling offset is 1kHz.</p>	

SOURce[1 2]:COUPle:FREQuency:RATio		Source Specific Command
Description	<p>Sets the frequency coupling ratio value for the selected channel. The default value is 1. Applicable for the AFG-3022 and AFG-3032 only.</p> <p>The frequency ratio is defined as: CH2 frequency / CH1 frequency. CH1 frequency is fixed regardless of whether the SOURce1 or SOURce2 command is used.</p>	
Syntax	SOURce[1 2]:COUPle:FREQuency:RATio {<ratio> MINimum MAXimum}	
Parameter	<ratio>	Range: 1000~0.001, resolution 0.001
	MINimum	Sets the ratio to the minimum (1000)
	MAXimum	Sets the ratio to the minimum (0.001)
Example	<p>SOUR1:COUP:FREQ:RAT 100</p> <p>Sets the ratio value of CH1 to 100.</p>	
Query Syntax	SOURce[1 2]:COUPle:FREQuency:RATio {[MINimum MAXimum]}	
Return Parameter	<NR3>	Returns the ratio.
Example	<p>SOUR1:COUP:FREQ:RAT?</p> <p>+1.000E+02</p> <p>Indicates that the ratio value for CH1 is 100.</p>	

SOURce[1|2]:COUPle:AMPLitude Source Specific Command

Description Sets or queries the amplitude coupling state. Amplitude coupling sets the amplitude of the selected channel to be the same as the other channel. By default amplitude coupling is turned off. Only applicable to the AFG-3022 and the AFG-3032.

Syntax **SOURce[1|2]:COUPle:AMPLitude {ON|OFF}**

Parameter	ON	Turns amplitude coupling on.
	OFF	Turns amplitude coupling off.

Example **SOURce1:COUP:AMPL ON**
Turns amplitude coupling on.

Query Syntax **SOURce[1|2]:COUPle:AMPLitude?**

Return Parameter	ON	Amplitude coupling is on.
	OFF	Amplitude coupling is off.

Example **SOUR1:COUP:AMPL?**
ON
Indicates that amplitude coupling is on.

SOURce[1|2]:TRACking:STATe Source Specific Command

Description Sets or queries the tracking state of the selected channel. Tracking will set the waveform shape, frequency and amplitude of one channel to be the same as the other channel. Only applicable to the AFG-3022 and the AFG-3032.

Syntax **SOURce[1|2]:TRACking:STATe {ON|INVerted|OFF}**

Parameter	ON	Turns channel tracking on.
	INVerted	Turns inverted channel tracking on.
	OFF	Turns channel tracking off.

Example	SOUR1:TRAC:STAT ON	
	Turns channel tracking on.	
Query Syntax	SOURce[1 2]:TRACking:STATe?	
Parameter	ON	Channel tracking is on.
	INV	Inverted channel tracking is on.
	OFF	Channel tracking is off.
Example	SOUR1:TRAC:STAT?	
	ON	
	Indicates that channel tracking is on.	

Reference Commands

SOURce[1 2]:REFerence		Source Specific Command
Description	Sets or queries the 10MHz reference source as internal or external.	
Syntax	SOURce[1 2]:REFerence {INTernal EXTernal}	
Parameter	INTernal	Sets the reference to the internal source.
	EXTernal	Sets the reference to the external source.
Example	SOUR1:REF INT Sets the reference to the internal source.	
Query Syntax	SOURce[1 2]:REFerence?	
Parameter	INT	The reference is the internal source.
	EXT	The reference is the external source.
Example	SOUR1:REF? INT Indicates that reference is set to internal.	
SOURce[1 2]:REFerence:SYNChronous		Source Specific Command
Description	Allows the unit to synchronize with a 10MHz external reference signal. Equivalent to the setting the clock source to EXT Sync when using the front panel operation.	
Syntax	SOURce[1 2]:REFerence:SYNChronous	

Save and Recall Commands

Up to 10 different instrument states can be stored to non-volatile memory (memory locations 0~9).

	Instrument Command
*SAV	
Description	Saves the current instrument state to a specified save slot. When a state is saved, all the current instrument settings, functions and waveforms are also saved.
Note	The *SAV command doesn't save waveforms in non-volatile memory, only the instrument state. The *RST command will not delete saved instrument states from memory.
Syntax	*SAV {0 1 2 3 4 5 6 7 8 9}
Example	*SAV 0 Save the instrument state to memory location 0.

	Instrument Command
*RCL	
Description	Recall previously saved instrument states from memory locations 0~9.
Syntax	*RCL {0 1 2 3 4 5 6 7 8 9}
Example	*RCL 0 Recall instrument state from memory location 0.

	Instrument Command
MEMory:STATe:DELeTe	
Description	Delete memory from a specified memory location.
Syntax	MEMory:STATe:DELeTe {0 1 2 3 4 5 6 7 8 9}

Example	MEM:STAT:DEL 0 Delete instrument state from memory location 0.	
MEMory:STATe:DELeTe ALL		Instrument Command
Description	Delete memory from all memory locations, 0~9.	
Syntax	MEMory:STATe:DELeTe ALL	
Example	MEM:STAT:DEL ALL Deletes all the instrument states from memory locations 0~9.	
MEMory:STATe?		Source Specific Command
Description	Queries the memory state of memory locations 0~9 as "Valid" or "Empty".	
Query Syntax	MEMory:STATe?	
Return Parameter	Returns the following string: 0:<state>,1:<state>,2:<state>,3:<state>,4:<state>,5:<state>,6:<state>,7:<state>,8:<state>,9:<state><state> Where state is "Empty" or "Valid".	
Example	MEMory:STATe? 0:Valid,1:Empty,2:Empty,3:Empty,4:Empty,5:Empty,6:Empty,7:Empty,8:Empty,9:Empty Indicates memory 0 is valid and all other memory locations are empty.	

Error Messages

The AFG-30XX has a number of specific error codes. Use the `SYSTem:ERRor` command to recall the error codes. For more information regarding the error queue, see page 404.

Command Error Codes

-101 Invalid character

An invalid character was used in the command string. Example: #, \$, %.

```
SOURce1:AM:DEPTH MIN%
```

-102 Syntax error

Invalid syntax was used in the command string. Example: An unexpected character may have been encountered, like an unexpected space.

```
SOURce1:APPL:SQUare , 1
```

-103 Invalid separator

An invalid separator was used in the command string. Example: a space, comma or colon was incorrectly used.

```
APPL:SIN 1 1000 OR SOURce1:APPL:SQUare
```

-108 Parameter not allowed

The command received more parameters than were expected. Example: An extra (not needed) parameter was added to a command

```
SOURce1:APPL? 10
```

-109 Missing parameter

The command received less parameters than expected. Example: A required parameter was omitted.

```
SOURce1:APPL:SQUare
```

-112 Program mnemonic too long

A command header contains more than 12 characters:

OUTP:SYNCHRONIZATION ON

-113 Undefined header

An undefined header was encountered. The header is syntactically correct. Example: the header contains a character mistake.

SOUR1:AMM:DEPT MIN

-123 Exponent too large

Numeric exponent exceeds 32,000. Example:

SOURce[1]:BURSt:NCYCles 1E34000

-124 Too many digits

The mantissa (excluding leading 0's) contains more than 255 digits.

-128 Numeric data not allowed

An unexpected numeric character was received in the command. Example: a numeric parameter is used instead of a character string.

SOURce1:BURSt:MODE 123

-131 Invalid suffix

An invalid suffix was used. Example: An unknown or incorrect suffix may have been used with a parameter.

SOURce1:SWEep:TIME 0.5 SECS

-138 Suffix not allowed

A suffix was used where none were expected. Example: Using a suffix when not allowed.

SOURce1:BURSt: NCYCles 12 CYC

-148 Character data not allowed

A parameter was used in the command where not allowed. Example: A discrete parameter was used where a numeric parameter was expected.

SOUR1:SWE:TRIG ON

-158 String data not allowed

An unexpected character string was used where none were expected. Example: A character string is used instead of a valid parameter.

SOURce1:SWEep:FUNCTion 'TEN'

-161 Invalid block data

Invalid block data was received. Example: The number of bytes sent with the DATA:DAC command doesn't correlate to the number of bytes specified in the block header.

-168 Block data not allowed

Block data was received where block data is not allowed. Example:

SOURce1:BURSt:NCYCles:CYCles #10

-170~177 expression errors

Example: The mathematical expression used was not valid.

Execution Errors

-211 Trigger ignored

A trigger was received but ignored. Example: Triggers will be ignored until the function that can use a trigger is enabled (burst, sweep, etc.).

-223 Too much data

Data was received that contained too much data. Example: An arbitrary waveform with over 8388708 points cannot be used.

-221 Settings conflict; turned off infinite burst to allow immediate trigger source

Example: Infinite burst is disabled when an immediate trigger source is selected. Burst count set to 1,000,000 cycles.

-221 Settings conflict; infinite burst changed trigger source to MANual

Example: The trigger source is changed to immediate from manual when infinite burst mode is selected.

-221 Settings conflict; burst period increased to fit entire burst

Example: The function generator automatically increases the burst period to allow for the burst count or frequency.

-221 Settings conflict; burst count reduced

Example: The burst count is reduced to allow for the waveform frequency if the burst period is at it's maximum.

-221 Settings conflict; trigger delay reduced to fit entire burst

Example: The trigger delay is reduced to allow the current period and burst count.

-221 Settings conflict;amplitude units changed to Vpp due to high-Z load

Example: If the output impedance is set to high, dBm units cannot be used. The units are automatically set to Vpp.

-221 Settings conflict: made compatible with pulse function

Example: When the function is changed to pulse, the output frequency is automatically reduced if over range.

-221 Settings conflict;frequency reduced for ramp function

Example: When the function is changed to ramp, the output frequency is automatically reduced if over range.

-221 Settings conflict;frequency reduced for triangle function

Example: When the function is changed to triangle, the output frequency is automatically reduced if over range.

-221 Settings conflict;frequency made compatible with burst mode

Example: When the function is changed to burst, the output frequency is automatically adjusted if over range.

-221 Settings conflict;not able to modulate this function

Example: A modulated waveform cannot be generated with noise or pulse waveforms.

-221 Settings conflict;not able to sweep this function

Example: A swept waveform cannot be generated with noise or pulse waveforms.

-221 Settings conflict: Burst function can not be performed under current setting.

Example: The burst function cannot be used with harmonic waveforms.

-221 Settings conflict: ARB Ncycle function can not be performed under current setting.

nNcycle function will be disabled.

-221 Settings conflict: Sweep Gate function can not be performed under current setting.

Gate function will be disabled.

-221 Settings conflict: Function can not be performed under current setting.

Function is disabled.

-221 Settings conflict;pulse width decreased due to period

Example: The pulse width has been adjusted to suit the period settings.

-221 Settings conflict;amplitude changed due to function

Example: The amplitude (VRM / dBm) has been adjusted to suit the selected function. For the AFG-30XX, a typical square wave has a much higher amplitude (5V Vrms) compared to a sine wave (~3.54) due to crest factor.

-221 Settings conflict;FM deviation cannot exceed carrier

Example: The deviation cannot be set higher than the carrier frequency

-221 Settings conflict;FM deviation exceeds max frequency

Example: If the FM deviation and carrier frequency combined exceeds the maximum frequency plus 100 kHz, the deviation is automatically adjusted.

-221 Settings conflict;frequency forced duty cycle change

Example: If the frequency is changed and the current duty cannot be supported at the new frequency, the duty will be automatically adjusted.

-221 Settings conflict:frequency forced symmetry change.

Example: This error occurs when SYM is set larger than 100%.

-221 Settings conflict;offset changed due to amplitude

Example: The offset is not a valid offset value, it is automatically adjusted, considering the amplitude.

$$|\text{offset}| \leq \text{max amplitude} - V_{pp}/2$$

-221 Settings conflict;amplitude changed due to offset

Example: The amplitude is not a valid value, it is automatically adjusted, considering the offset.

$$V_{pp} \leq 2X (\text{max amplitude} - |\text{offset}|)$$

-221 Settings conflict;low level changed due to high level

Example: The low level value was set too high. The low level is set 1 mV less than the high level.

-221 Settings conflict;high level changed due to low level

Example: The high level value was set too low. The high level is set 1 mV greater than the low level.

-222 Data out of range;value clipped to upper limit

Example: The parameter was set out of range. The parameter is automatically set to the maximum value allowed.

SOURce[1]:FREQuency 30.1MHz.

-222 Data out of range;value clipped to lower limit

Example: The parameter was set out of range. The parameter is automatically set to the minimum value allowed.

SOURce[1]:FREQuency 0.1μHz.

-222 Data out of range: pulse width limited by period.

Example: The pulse width is limited by the period according to the formula below.

$$\text{Period} \geq \text{Width} + 0.625 * [(\text{Rise Time} - 0.6\text{nS}) + (\text{Fall Time} - 0.6\text{nS})]$$

To resolve the error, set the duty to the smallest possible value and then increase the frequency until the duty changes accordingly.

-222 Data out of range: pulse rise/fall time limited by pulse width

Example: The rise/fall time is limited by the pulse width according to the formula below.

$$\text{Width} - 0.625 * [(\text{Rise Time} - 0.6\text{nS}) + (\text{Fall Time} - 0.6\text{nS})] \geq 0$$

-222 Data out of range;period;

Example: If the period was set to a value out of range, it is automatically set to an upper or lower limit.

-222 Data out of range;frequency;

Example: If the frequency was set to a value out of range, it is automatically set to an upper or lower limit.

-222 Data out of range;user frequency; value clipped to upper limit

Example: If the frequency is set to a value out of range for an arbitrary waveform using SOURCE[1 | 2]: APPL:USER, it is automatically set to the upper limit.

-222 Data out of range;ramp frequency; value clipped to upper limit

Example: If the frequency is set to a value out of range for a ramp waveform using, SOURCE[1 | 2]: APPL: RAMP, it is automatically set to the upper limit.

-222 Data out of range;pulse frequency; value clipped to upper limit

Example: If the frequency is set to a value out of range for a pulse waveform using, SOURCE[1 | 2]: APPL:PULS, it is automatically set to the upper limit.

-222 Data out of range;burst period;

Example: If the burst period was set to a value out of range, it is automatically set to an upper or lower limit.

222 Data out of range;burst count;

Example: If the burst count was set to a value out of range, it is automatically set to an upper or lower limit.

-222 Data out of range; burst period limited by length of burst; value clipped to upper limit

Example: The burst period must be greater than burst count divided by the frequency + 200 ns. The burst period is adjusted to satisfy these conditions.

$\text{burst period} > 200 \text{ ns} + (\text{burst count} / \text{burst frequency})$.

-222 Data out of range; burst count limited by length of burst; value clipped to lower limit

Example: The burst count must be less than burst period * the waveform frequency when the trigger source is set to immediate (SOURce[1 | 2]:BURSt:TRIGger IMM). The burst count is automatically set to the lower limit.

-222 Data out of range; amplitude;

Example: If the amplitude was set to a value out of range, it is automatically set to an upper or lower limit.

-222 Data out of range; offset;

Example: If the offset was set to a value out of range, it is automatically set to an upper or lower limit.

-222 Data out of range; frequency in burst mode;

Example: If the frequency was set to a value out of range in burst mode. The burst frequency is automatically set to an upper or lower limit, taking the burst period into account.

-222 Data out of range; frequency in FM;

Example: The carrier frequency is limited by the frequency deviation (SOURce[1]: FM:DEV). The carrier frequency is automatically adjusted to be less than or equal to the frequency deviation.

-222 Data out of range;FM deviation; value clipped to ...

Example: The frequency deviation is outside of range. The deviation is automatically adjusted to an upper or lower limit, depending on the frequency.

-222 Data out of range;trigger delay; value clipped to upper limit

Example: The trigger delay was set to a value out of range. The trigger delay has been adjusted to the maximum (85 seconds).

-222 Data out of range; trigger delay limited by length of burst; value clipped to upper limit

Example: The trigger delay and the burst cycle time combined must be less than the burst period.

-222 Data out of range;duty cycle;

Example: The duty cycle is limited depending on the frequency.

Duty Cycle	Frequency
40%~60%	25 MHz ~ 30MHz
20%~80%	< 25 MHz

-222 Data out of range; duty cycle limited by frequency; value clipped to upper limit

Example: The duty cycle is limited depending on the frequency. When the frequency is greater than 25 MHz, the duty cycle is automatically limited to 60%.

-313 Calibration memory lost;memory corruption detected

Indicates that a fault (check sum error) has occurred with the non-volatile memory that stores the calibration data.

-314 Save/recall memory lost;memory corruption detected

Indicates that a fault (check sum error) has occurred with the non-volatile memory that stores the save/recall files.

-315 Configuration memory lost;memory corruption detected

Indicates that a fault (check sum error) has occurred with the non-volatile memory that stores the configuration settings.

-350 Queue overflow

Indicates that the error queue is full (over 20 messages generated, and not yet read). No more messages will be stored until the queue is empty. The queue can be cleared by reading each message, using the *CLS command or restarting the function generator.

Query Errors

-410 Query INTERRUPTED

Indicates that a command was received but the data in the output buffer from a previous command was lost.

-420 Query UNTERMINATED

The function generator is ready to return data, however there was no data in the output buffer. For example: Using the APPLY command.

-430 Query DEADLOCKED

Indicates that a command generates more data than the output buffer can receive and the input buffer is full. The command will finish execution, though all the data won't be kept.

Arbitrary Waveform Errors

-770 Nonvolatile arb waveform memory corruption detected

Indicates that a fault (check sum error) has occurred with the non-volatile memory that stores the arbitrary waveform data.

-781 Not enough memory to store new arb waveform; bad sectors

Indicates that a fault (bad sectors) has occurred with the non-volatile memory that stores the arbitrary waveform data. Resulting in not enough memory to store arbitrary data.

-787 Not able to delete the currently selected active arb waveform

Example: The currently selected waveform is being output and cannot be deleted.

800 Block length must be even

Example: As block data (DATA:DAC VOLATILE) uses two bytes to store each data point, there must be an even number of bytes for a data block.

SCPI Status Registers

The status registers are used to record and determine the status of the function generator.

The function generator has a number of register groups:

Questionable Status Registers

Standard Event Status Registers

Status Byte Register

As well as the output and error queues.

Each register group is divided into three types of registers: condition registers, event registers and enable registers.

Register types

Condition Register	The condition registers indicate the state of the function generator in real time. The condition registers are not triggered. I.e., the bits in the condition register change in real time with the instrument status. Reading a condition register will not clear it. The condition registers cannot be cleared or set.
Event Register	The Event Registers indicate if an event has been triggered in the condition registers. The event registers are latched and will remain set unless the *CLS command is used. Reading an event register will not clear it.
Enable Register	The Enable register determines which status event(s) are enabled. Any status events that are not enabled are ignored. Enabled events are used to summarize the status of that register group.

AFG-30XX Status System

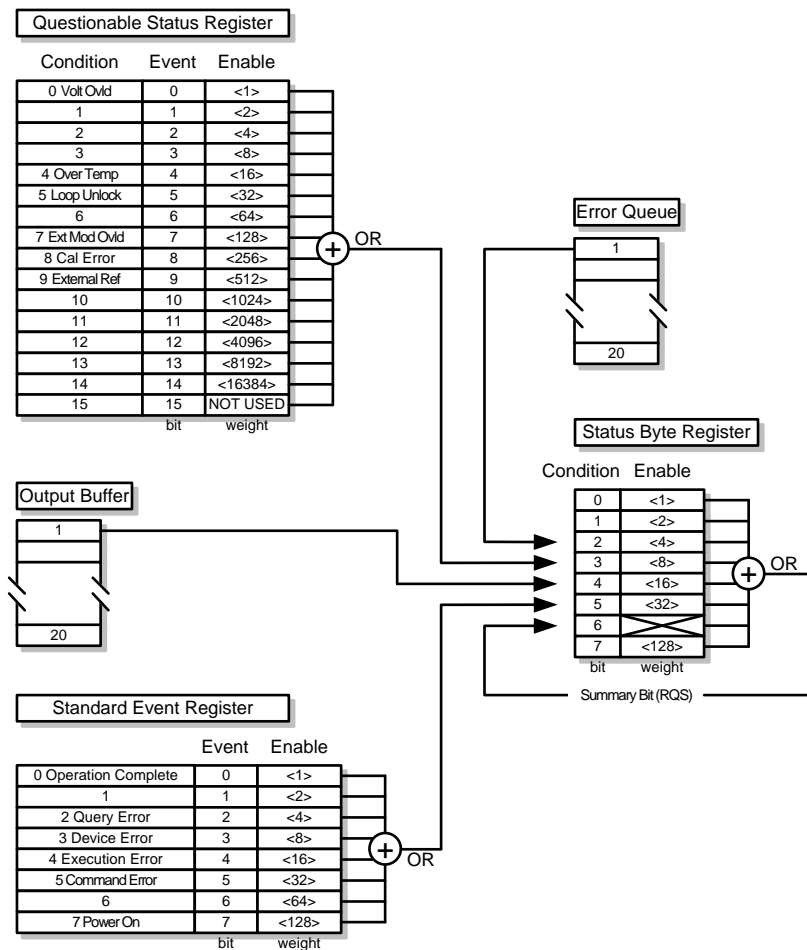

Questionable Status Register

Description	The Questionable Status Registers will show if any faults or errors have occurred.		
Bit Summary	Register	Bit	Bit Weight
	Voltage overload	0	1
	Over temperature	4	16
	Loop unlock	5	32
	Ext Mod Overload	7	128
	Cal Error	8	256
	External Reference	9	512

Standard Event Status Registers

Description	The Standard Event Status Registers indicate when the *OPC command has been executed or whether any programming errors have occurred.
Notes	<p>The Standard Event Status Enable register is cleared when the *ESE 0 command is used.</p> <p>The Standard Event Status Event register is cleared when the *CLS command or the *ESR? command is used.</p>

Bit Summary	Register	Bit	Bit Weight
	Operation complete bit	0	1
	Query Error	2	4
	Device Error	3	8
	Execution Error	4	16
	Command Error	5	32
	Power On	7	128

Error Bits		
	Operation complete	The operation complete bit is set when all selected pending operations are complete. This bit is set in response to the *OPC command.
	Query Error	The Query Error bit is set when there is an error reading the Output Queue. This can be caused by trying to read the Output Queue when there is no data present.
	Device Error	The Device Dependent Error indicates a failure of the self-test, calibration, memory or other device dependent error.
	Execution Error	The Execution bit indicates an execution error has occurred.
	Command Error	The Command Error bit is set when a syntax error has occurred.
	Power On	Power has been reset.

The Status Byte Register

Description The Status Byte register consolidates the status events of all the status registers. The Status Byte register can be read with the *STB? query or a serial poll and can be cleared with the *CLS command.

Clearing the events in any of the status registers will clear the corresponding bit in the Status Byte register.

Notes The Status byte enable register is cleared when the *SRE 0 command is used.

The Status Byte Condition register is cleared when the *CLS command is used.

Bit Summary	Register	Bit	Bit Weight
	Error Queue	2	4
	Questionable Data	3	8
	Message Available	4	16
	Standard Event	5	32
	Master Summary / Request Service	6	64

Status Bits	Error Queue	There are error message(s) waiting in the error queue.
	Questionable data	The Questionable bit is set when an “enabled” questionable event has occurred.
	Message Available	The Message Available bit is set when there is outstanding data in the Output Queue. Reading all messages in the output queue will clear the message available bit.

Standard Event The Event Status bit is set if an “enabled” event in the Standard Event Status Event Register has occurred.

Master Summary/Service Request bit The Master Summary Status is used with the *STB? query. When the *STB? query is read the MSS bit is not cleared.

The Request Service bit is cleared when it is polled during a serial poll.

Output Queue

Description The Output queue stores output messages in a FIFO buffer until read. If the Output Queue has data, the MAV bit in the Status Byte Register is set.

Error Queue

Description The error queue is queried using the SYSTem:ERRor? command. The Error queue will set the “Error Queue” bit in the status byte register if there are any error messages in the error queue. If the error queue is full the last message will generate a “Queue overflow” error and additional errors will not be stored. If the error queue is empty, “No error” will be returned.

Error messages are stored in the error queue in a first-in-first-out order. The errors messages are character strings that can contain up to 255 characters.

APPENDIX

Fuse Replacement

- Procedure
1. Remove the power cord and remove the fuse socket using a minus driver.

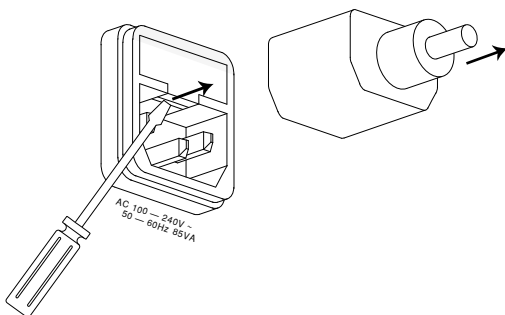

2. Replace the fuse in the holder.

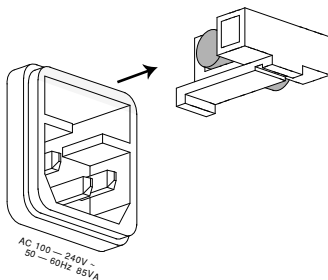

Ratings

AFG-3022 & AFG-3032: T1A/250V
AFG-3021 & AFG-3031: T0.63A/250V

AFG-3021, AFG-3022, AFG-3031 & AFG-3032 Specifications

The specifications apply when the function generator is powered on for at least 30 minutes under +20°C~+30°C.

General Specification		AFG-3021	AFG-3031	AFG-3022	AFG-3032
Channels		1	1	2	2
Instrument		Isolated	Isolated	Isolated	Isolated
Chassis					
Signal Ground		—	—	Isolated	Isolated
Waveforms		Sine, Square, Ramp, Pulse, Noise, Harmonic, DC			
Arbitrary Waveforms		Built in			
Sample Rate		250 MSa/s			
Repetition Rate		125MHz			
Waveform Length		8M points			
Amplitude		16 bits			
Resolution		Ten 8M waveforms(1)			
Non-Volatile Memory		Any section from 2 to 8M points			
User-defined Output Section		External			
Trigger		Sine, Square, Ramp, Sinc, Exp Rise, Exp Fall, DC, Pulse, Abstan, Haversine, Sinever, Absin, Haversine, Stair_down, Abssinehalf, N_pulse, Stair_UD, Ampalt, Negramp, Stair_up, Attalt, Rectpuls1, Stepresp, Diric_even, Roundhalf, Trapezia, Diric_odd, Sawtoot, Tripuls1, Gauspuls1, Sinetra, Dlorentz, Ln, Sqrt, Since, Lorentz, Xsquare, Gauss, Arccos, Arctan, Sech, Arccot, Arctanh, Sinh, Arccsc, Cosh, Tan, Arcsec, Cot, Tanh, Arcsin, Csc, Arcsinh, Sec, Barthannwin, Chebwin, Kaiser, Bartlett, Flattopwin, Triang, Blackman, Hamming, Tukeywin, Bohmanwin, Hann			

Frequency Characteristics					
Range	Sine	20MHz	30MHz	20MHz	30MHz
	Square	20MHz	30MHz	20MHz	30MHz
	Triangle, Ramp	1MHz			
Resolution		1μHz			
Accuracy	Stability	±1 ppm 0 to 50°C ±0.3 ppm 18 to 28°C			
	Aging	±1 ppm, per 1 year			
	Tolerance	≤1 μHz			
Output Characteristics(2)					
Amplitude	Range	1 mVpp to 10 Vpp(into 50Ω) 2 mVpp to 20 Vpp(open-circuit)			
	Accuracy	± 1% of setting ±1 mVpp (at 1 kHz/into 50Ω without DC offset)			
	Resolution	0.1 mV or 4 digits			
	Flatness	±0.1dB: <10 MHz ±0.2 dB: 10 MHz to 30 MHz (sinewave relative to 1 kHz/into 50Ω)			
	Units	Vpp, Vrms, dBm,			
Offset	Range	±5 Vpk ac +dc (into 50Ω) ±10Vpk ac +dc (open circuit)			
	Accuracy	1% of setting + 2 mV + 0.5% Amplitude			
Waveform Output	Impedance	50Ω typical (fixed) > 10MΩ (output disabled)			
	Protection	Short-circuit protected Overload relay automatically disables main output			
	Ground Isolation	42Vpk max.			
Sync Output	Level	TTL-compatible into>1kΩ			
	Impedance	50Ω nominal			
	Ground Isolation	42Vpk max. (same ground as CH1 output)			
Sine wave Characteristics					
Distortion(5)	Harmonic	-60 dBc	DC ~ 1 MHz, Ampl<3 Vpp		
	Total Harmonic Distortion	-55 dBc	DC ~ 1 MHz, Ampl>3 Vpp		
		-45 dBc	1MHz ~ 5 MHz, Ampl>3 Vpp		
		-30 dBc	5MHz ~ 30 MHz, Ampl>3 Vpp		
Spurious (non-harmonic) (5)	Total Harmonic Distortion	< 0.2%+0.1mVrms DC to 20 kHz			
	Phase Noise	-60 dBc	DC~1 MHz		
		-50 dBc	1MHz~20MHz		
		-50 dBc + 6 dBc/octave	1MHz~30MHz(AFG-3031/3032 only)		

Square wave Characteristics				
Rise/Fall Time	<8 ns(3)			
Overshoot	<5%			
Asymmetry	1% of period +1 ns			
Variable Duty Cycle	20.0% to 80.0%:	20.0% to 80.0%:	20.0% to 80.0%:	20.0% to 80.0%:
	≤ 20 MHz	≤ 25 MHz	≤ 20 MHz	≤ 25 MHz
		40.0% to 60.0%:		40.0% to 60.0%:
		25~30MHz		25~30MHz
Jitter	0.01%+525ps < 2 MHz 0.1%+75ps > 2 MHz			
Ramp Characteristics				
Linearity	< 0.1% of peak output			
Variable Symmetry	0% to 100% (0.1% resolution)			
Pulse Characteristics				
Frequency	1uHz ~ 20MHz	1uHz ~ 25MHz	1uHz ~ 20MHz	1uHz ~ 25MHz
Width	20ns ~ 999.83ks			
	$\text{Width} - 0.625 * [(\text{Rise Time} - 0.6\text{ns}) + (\text{Fall Time} - 0.6\text{ns})] \geq 0$			
	$\text{Period} \geq \text{Width} + 0.625 * [(\text{Rise Time} - 0.6\text{ns}) + (\text{Fall Time} - 0.6\text{ns})]$			
Duty Setting Range	0.017% to 99.983%			
Period	40ns ~ 1000000s			
Rise time and Fall Time	9.32ns ~ 799.9ks			
Resolution	0.0001%			
Overshoot	< 5%			
Jitter	50ps typical (<10kHz)			
Noise				
Noise Type	Gaussian			
Noise Bandwidth	100MHz equivalent bandwidth			
Harmonic				
Harmonic Order	≤ 8			
Harmonic Type	Even, Odd, All, User Amplitude and Phase can be set for all harmonics			

AM Modulation				
Carrier Waveforms	Sine, Square, Triangle, Ramp, Pulse, Arb			
Modulating Waveforms	Sine, Square, Triangle, Up/Dn Ramp			
Modulating Frequency	2mHz to 20kHz			
Depth	0% to 120.0%			
Source	Internal / External			
FM Modulation				
Carrier Waveforms	Sine, Square, Triangle, Ramp			
Modulating Waveforms	Sine, Square, Triangle, Up/Dn Ramp			
Modulating Frequency	2mHz to 20kHz			
Peak Deviation	DC to 30MHz(1 uHz resolution) (DC to 20MHz for AFG-3021/3022)			
Source	Internal / External			
PWM				
Carrier Waveforms	Square			
Modulating Waveforms	Sine, Square, Triangle, Up/Dn Ramp			
Modulating Frequency	2mHz to 20kHz			
Deviation	0% ~ 100.0% of pulse width, 0.1% resolution			
Source	Internal / External			
FSK				
Carrier Waveforms	Sine, Square, Triangle, Ramp			
Modulating Waveforms	50% duty cycle square			
Internal Rate	2mHz to 100kHz			
Frequency Range	DC to 20MHz	DC to 30MHz	DC to 20MHz	DC to 30MHz
Source	Internal / External			
Additive modulation (Sum)				
Carrier Waveforms	Sine, Triangle, Ramp, Pulse, Noise			
Modulating Waveforms	Sine, Square, Triangle, Up/Dn Ramp			
Ratio	0% to 100% of carrier amplitude, 0.01% resolution			

	Modulating Frequency	2mHz to 20kHz
	Source	Internal /External
PM		
	Carrier Waveforms	Sine, Triangle, Ramp
	Modulating Waveforms	Sine, Square, Triangle, Up/Dn Ramp
	Phase Deviation Setting Range	0° to 360°, 0.1° resolution
	Modulating Frequency	2mHz to 20kHz
	Source	Internal
Sweep		
	Waveforms	Frequency Sweep: Sine, Square, Triangle, Ramp Amplitude Sweep: Sine, Square, Triangle, Ramp, Pulse, Noise, ARB
	Type	Frequency, Amplitude
	Functions	Linear or Logarithmic
	Directions	Up or Down
	Start/Stop Frequency	Any frequency within the waveform's range
	Sweep Time	1ms to 500s (1ms resolution)
	Hold Time	
	Return Time	
	Trigger Mode	Single, External, Internal
	Trigger Source	Internal/External
Burst		
	Waveforms	Sine, Square, Triangle, Ramp, Pulse and Noise
	Frequency	1μHz to 20MHz 1μHz to 30MHz(4) 1μHz to 20MHz 1μHz to 30MHz(4)
	Burst Count	1 to 1000000 cycles or Infinite
	Start/Stop Phase	-360.0° to +360.0° (0.1° resolution)
	Internal Period	1us to 500s
	Gate Source	External Trigger (pulse waveforms can only be used in gate mode)
	Trigger Source	Single, External or Internal Rate
	Trigger Delay	N-Cycle, Infinite: 0us to 100s(1us resolution)
External Modulation Input		
	Type	AM, FM, PWM, Sum
	Voltage Range	± 5V full scale
	Input Impedance	10kΩ
	Frequency	DC to 20kHz

	Ground Isolation	42Vpk max. (same ground as corresponding channel)
Modulation Output (AFG-3021/3031)		
	Type	AM, FM, PWM, PM, Sum, Sweep
	Amplitude	≥ 1Vpp
	Impedance	> 10kΩ typical
External Trigger Input		
	Type	For FSK, Burst, Sweep, N Cycle ARB
	Input Level	TTL Compatibility
	Slope	Rising or Falling (Selectable)
	Pulse Width	>100ns
	Input rate	DC to 1MHz
	Input Impedance	10kΩ, DC coupled
Latency	Sweep	<10us (typical)
	Burst	<100ns (typical)
Jitter	Sweep	2.5 us
	Burst	1 ns; except pulse, 300 ps
10 MHz Reference Output		
	Output Voltage	1 Vp-p/50Ω square wave
	Output Impedance	50Ω, AC coupled
	Output Frequency	10MHz
10 MHz Reference Input		
	Input Voltage	0.5Vp-p to 5Vp-p
	Input Impedance	1kΩ, unbalanced, AC coupled
	Max. Allowed Input	± 10Vdc
	Input Frequency	10MHz ± 10Hz
	Waveform	Sine or square (50±5% duty)
	Ground Isolation	42Vpk max.
External-Sync		
	Phase Delay (max.)	Series Connection: $39+(N-2)*39 \pm 25nS$ Parallel connection: $(N-1)*6 \pm 25nS$ (where N=number of connected units)
	Maximum number of connected units	Series Connection: 4 Parallel Connection: 6
	Applicable Functions	Sine, Square, Triangle, Pulse, Ramp, Harmonic, MOD, Sweep, Burst

Store/Recall	10 Groups of Setting Memories
Interface	GPIB(optional), LAN, USB
Display	4.3 inch TFT LCD, 480 × 3 (RGB) × 272

General Specifications

Power Source	AC100 - 240V, 50 - 60Hz
Power	85 VA for AFG-3032 & AFG-3022
Consumption	50VA for AFG-3021 & AFG-3031
Operating Environment	Temperature to satisfy the specification: 18 ~ 28°C Operating temperature: 0 ~ 40°C Relative Humidity: ≤ 80%, 0 ~ 40°C ≤ 70%, 35 ~ 40°C Installation category: CAT II
Operating Altitude	2000 meters
Pollution Degree	EN 61010 Degree 2, Indoor Use
Storage Temperature	-10~70°C, Humidity: ≤70%
Dimensions	Bench Top 265(W) x 107(H) x 374(D)
	Weight Approx. 3.5kg
	Safety Designed to EN 61010-1
	EMC Tested to EN 61326, EN 55011
	Accessories Test cable(GTL-110x1 for AFG-3021/3031, GTL-110x2 for AFG-3022/3032), User Manual Compact Disk x 1, Quick Start Guide x 1, Power cord x 1

- (1). A total of ten waveforms can be stored. (Every waveform can be composed of 8M points maximum.)
- (2). Add 1/10th of output amplitude and offset specification per °C for operation outside of 0°C to 28°C range (1-year specification).
- (3). Edge time decreased at higher frequency.
- (4). Sine and square waveforms above 25 MHz are allowed only with an "Infinite" burst count.
- (5). Harmonic distortion and Spurious noise at low amplitudes is limited by a -70 dBm floor.

EC Declaration of Conformity

We

GOOD WILL INSTRUMENT CO., LTD.

No.7-1, Jhongsing Rd., Tucheng City, Taipei County 236, Taiwan

GOOD WILL INSTRUMENT (SUZHOU) CO., LTD.

No. 69, Lushan Road, Suzhou New District Jiangsu, China

declares that the below mentioned product

AFG-3021, AFG-3031, AFG-3022, AFG-3032

Are herewith confirmed to comply with the requirements set out in the Council Directive on the Approximation of the Law of Member States relating to Electromagnetic Compatibility (2004/108/EC & 2014/30/EU) and Low Voltage Equipment Directive (2006/95/EC & 2014/35/EU). For the evaluation regarding the Electromagnetic Compatibility and Low Voltage Directive, the following standards were applied:





© EMC





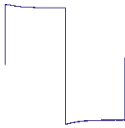

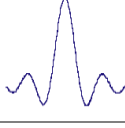
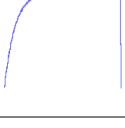
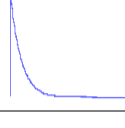
EN 61326-1 :	Electrical equipment for measurement, control and	
EN 61326-2-1:	laboratory use — EMC requirements (2013)	
Conducted and Radiated Emissions EN 55011:2009+A1:2010	Electrostatic Discharge EN 61000-4-2: 2009	
Current Harmonic EN 61000-3-2:2014	Radiated Immunity EN 61000-4-3:2006+A1:2008+A2:2010	
Voltage Fluctuation EN 61000-3-3:2013	Electrical Fast Transients EN 61000-4-4:2012	
-----	Surge Immunity EN 61000-4-5: 2006	
-----	Conducted Susceptibility EN 61000-4-6: 2014	
-----	Power Frequency Magnetic Field EN 61000-4-8:2010	
-----	Voltage Dips/ Interrupts EN 61000-4-11: 2004	

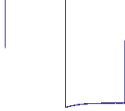

© Safety

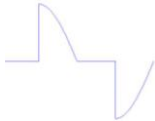

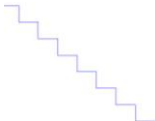
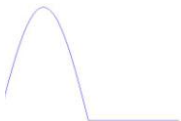
Low Voltage Directive 2006/95/EC & 2014/35/EU
Safety Requirements EN 61010-1:2010 (Third Edition) EN 61010-2-030:2010 (First Edition)

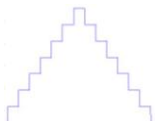

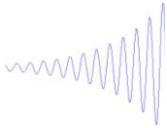

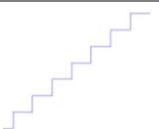
ARB Built-In Waveforms

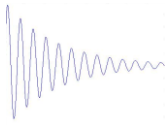
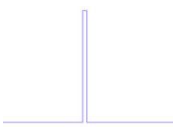
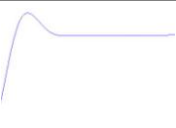

Basic		
Sine	$y = \sin(x)$	
Square	50% duty square waveform	
Ramp	50% symmetry	
Sinc	$y = \text{sinc}(x)$	
Exp Rise	Exponential rise	
Exp Fall	Exponential fall	
DC	DC waveform	
Pulse	Pulse waveform with user-defined frequency and duty	

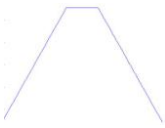
Common 1		
Absatan	$y = \text{atan}(x) $ The absolute of atan(x)	
Havercosine	$y = (1 - \sin(x))/2$ Havercosine function	
Sinever	Piecewise sine function	
Abssin	$y = \sin(x) $ The absolute of sin(x)	
Haversin	$y = (1 - \cos(x))/2$ Haversine function	
Stair_down	Step down	
Abssinehalf	$y = \sin(x), 0 < x < \pi$ $y = 0, \pi < x < 2\pi$ Half_wave function	
N_pulse	Negative pulse	
Stair_ud	Step up and step down	

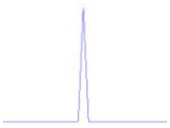

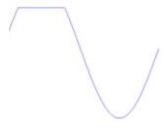
Ampalt	$y=e(x).\sin(x)$ Oscillation rise	
Negramp	$y=-x$ Line segment	
Stair_up	Step up	





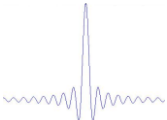
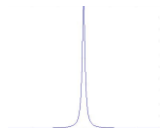
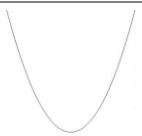
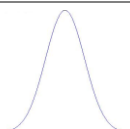

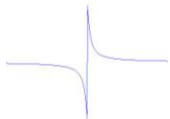
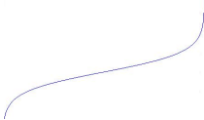

Common 2		
Attalt	$y=e(-x).\sin(x)$ Oscillation down	
Rectpuls	Sampled aperiodic rectangle	
Stepresp	Heaviside step function	
Diric	Even $f(x)=-1^{(x*(n-1)/2*\pi)}$ $x=0,\pm 2*\pi,\pm 4*\pi,\dots$	
Roundhalf	$y=\sqrt{1-x^2}$ The half roud	

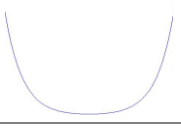

Trapezia	Piecewise function	
Diric	Odd $f(x)=\sin(nx/2)/n*\sin(x/2)$ $x=\pm\pi,\pm3\pi, \dots$	
Sawtoot	Sawtooth or triangle wave	
Tripuls	Sampled aperiodic triangle	
Gauspuls	$f(x)=a*e^{-(x-b)^2}/c^2$ Gaussian-modulated sinusoidal pulse	
Sinetra	Piecewise function	





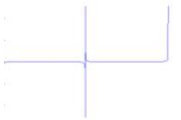

Math		
Dlorentz	The derivative of the lorentz function $y=-2x/(k*x^2+1)$	
Ln	Logarithm function	
Sqrt	$y=\text{sqrt}(x)$	

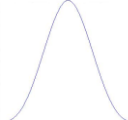

Sinec	$y = \sin(x)/x$	
Lorentz	Lorentz function $y = 1/(k \cdot x^2 + 1)$	
Xsquare	Parabola	
Gauss	A waveform representing a gaussian bell curve	

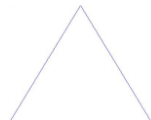
Trig		
Arccos	Arc cosine	
Arctan	Arc tangent	
Sech	Hyperbolic secant	
Arccot	Arc cotangent	
Arctanh	Hyperbolic arc tangent	

Sinh	Hyperbolic sine	
Arccsc	Arc cosecant	
Cosh	Hyperbolic cosine	
Tan	Tangent	
Arcsec	Arc secant	
Cot	Cotangent	
Tanh	Hyperbolic tangent	
Arcsin	Arc sine	
Csc	Cosecant	

Arcsinh	Hyperbolic arc sine	
Sec	Secant	

Window		
Barthannwin	Modified Bartlett-Hann window	
Chebywin	The Chebyshev window function	
Kaiser	The Kaiser window function	
Bartlett	The Bartlett window is very similar to a triangular window as returned by the triang function.	
Flattpwin	The Flattopwin window function	
Triang	The Triang window function	
Blackman	The Blackman window function	

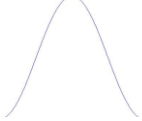
Hamming	The Hamming window function	
Tukeywin	The Tukey window function	
Bohmanwin	The Bohman window function	
Hann	The Hann window function	

INDEX

Amplitude coupling.....	183	safety instructions	9
Arbitrary waveforms	190	Equipment category	10
Built-In.....	191	Ethernet interface.....	233
display	198	Firmware.....	168
navigation.....	202	Frequency coupling.....	181
overview.....	204	Front panel diagram.....	15
editing	205	Function keys	
inserting	191	key overview	16
saving	221	Fuse replacement	405
Beeper	170	safety instruction	8
Built-in ARB waveforms.....	414	GPIB	
Caution symbol.....	6	remote control interface	232
Channel tracking	184	Ground	
Cleaning the instrument.....	9	symbol	6
Declaration of conformity	413	Help menu	29
Default settings.....	68	interface.....	230
Digital inputs	28	LAN interface.....	233
Display		Language selection	169
diagram	23	List of features.....	12
Display brightness.....	171	Menu Tree.....	51
Display suspend	171	Modulation	89
Disposal		AM	91
symbol	7	Burst.....	146
Disposal instructions.....	10	FM.....	100
DSO link	175, 180	PM.....	115
Dual channel	178	PWM.....	128
amplitude coupling.....	183	SUM.....	121
channel tracking	184	Multi-unit sync	
dso link.....	175, 180	connection.....	186
frequency coupling.....	181	setup	188
output impedance	179	Operation	
phase.....	178	Amplitude	87
EN61010		Channel selection	71
measurement category	7	DC Wave.....	84
pollution degree.....	9	Frequency	85
Environment		Harmonic Characteristics.....	83
		Harmonic Order	81
		Harmonic Wave.....	80

Noise Wave	80	LAN	164
Offset	88	LAN host name.....	166
Pulse duty	78	SCPI registers	399
Pulse rise & fall time	76, 77	screen lock	236
Pulse width.....	75	Syntax	240
Ramp	79	terminal connection	235
Sine.....	72	USB	167
Square.....	73	Screen lock	236
Triangle	74	Secondary System Settings	158
Operation keys		Remote interface	163
key overview	16	System and Settings	168
Operation menu	70	Service operation	
Output indicators	17	about disassembly	7
Output terminals	18	Set output impedance.....	174, 179
Phase settings	178	Setting up the instrument	24
Power on/off		Software	168
safety instruction	8, 10	Specifications	406
Power up.....	25	Syncing multiple units	186
Quick reference	26	Tracking	184
Rear panel diagram	20	UK power cord	11
Reference clock.....	172	Updating Software and firmware	
remote control		168
interface configuration	230, 237	USB	
Remote interface	229	remote control interface	230
Error messages	386	Warning symbol.....	6
functionality check	235		
GPIB.....	163		